

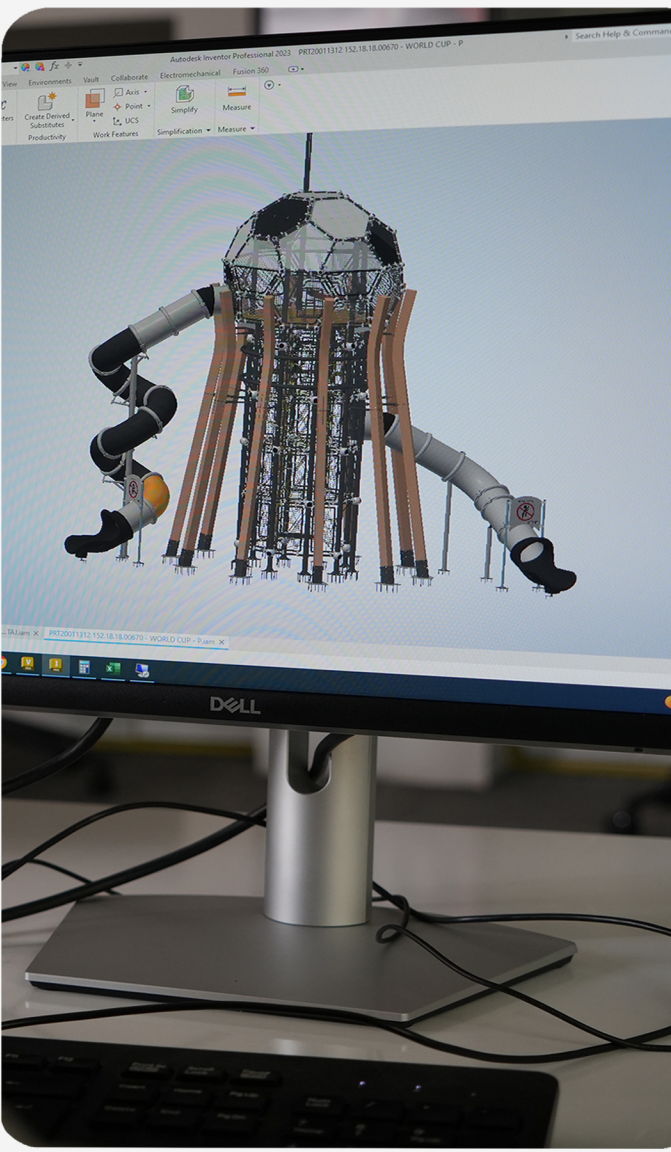

dreams come true™
Cemer

Respond quickly within 1 week.

Our experienced team is committed to providing quick support for any issues you encounter. We focus on timely resolutions and continuously improve our processes to ensure a seamless experience. Offering personalized solutions tailored to your needs, we aim to exceed your expectations and build a lasting, positive relationship.



dreams come true™
Cemer

We recognize the importance of providing prompt solutions.

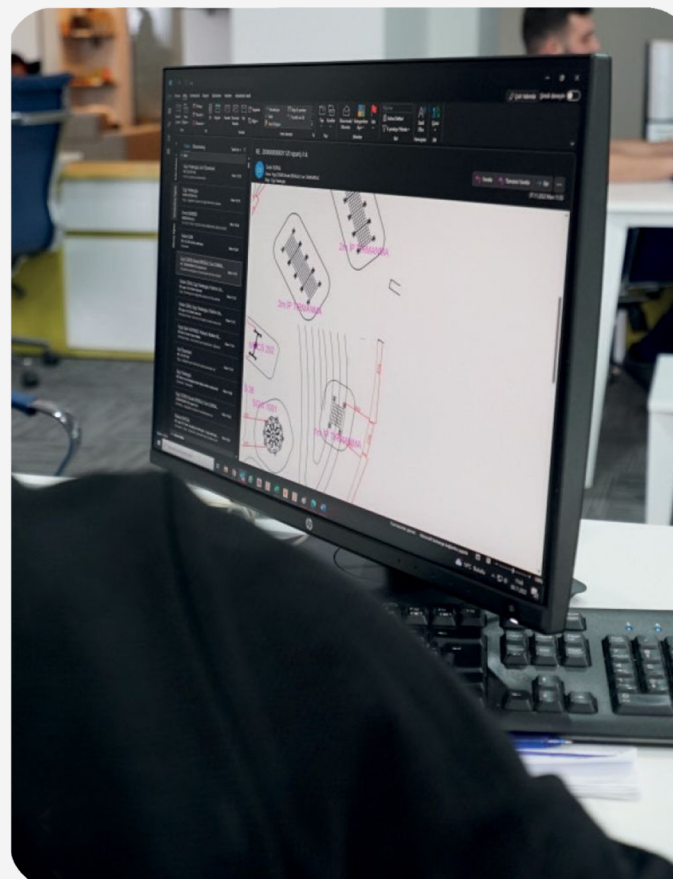

Get Results in 1 Week

• **Opportunity to meet one-on-one with the designers & engineers.**

Direct communication with designers and engineers allows for a more efficient, personalized approach. Close collaboration with product experts ensures precise solutions, faster problem-solving, and a tailored experience. Your feedback drives continuous improvement and innovation.

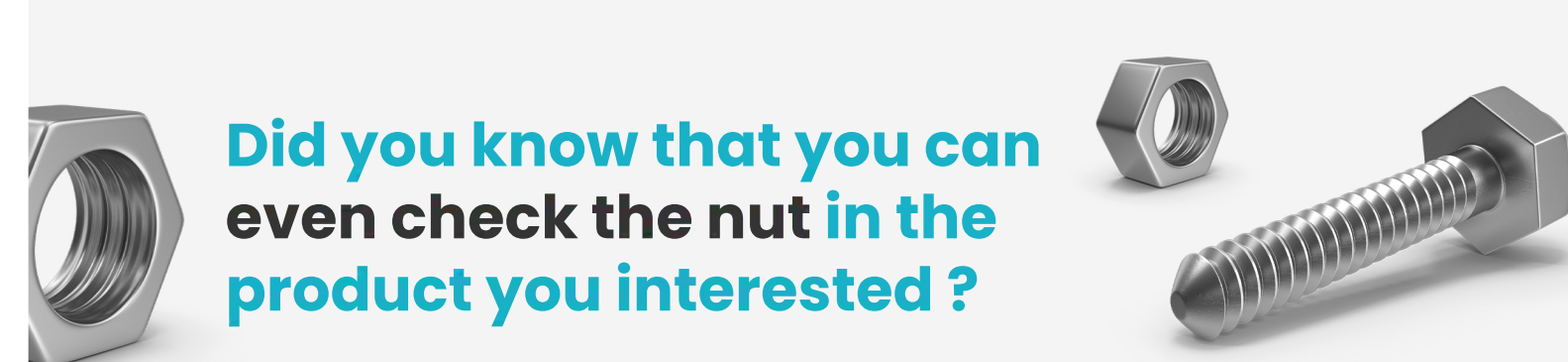

Did you know that you can even check the nut in the product you interested?

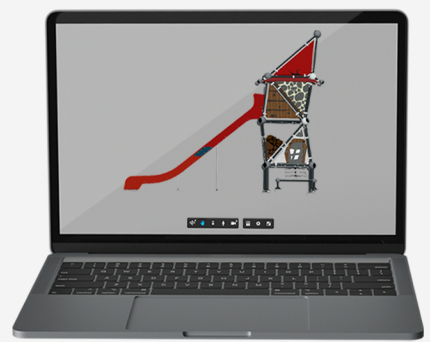

You can access all parts of the products.

You can explore the product's 360 features on both your **phone and PC.** You'll find content such as the **3D model, exploded view, spare parts.**



This tool allows you to zoom in the spare part selected from the model, view it in detail and access the part code.



You can see the product's in the finest detail.



This tool allows you to view the internal structure or details of objects by breaking them into pieces.



This tool provides detailed measurements of all the parts on the product.

ACCESS MENU

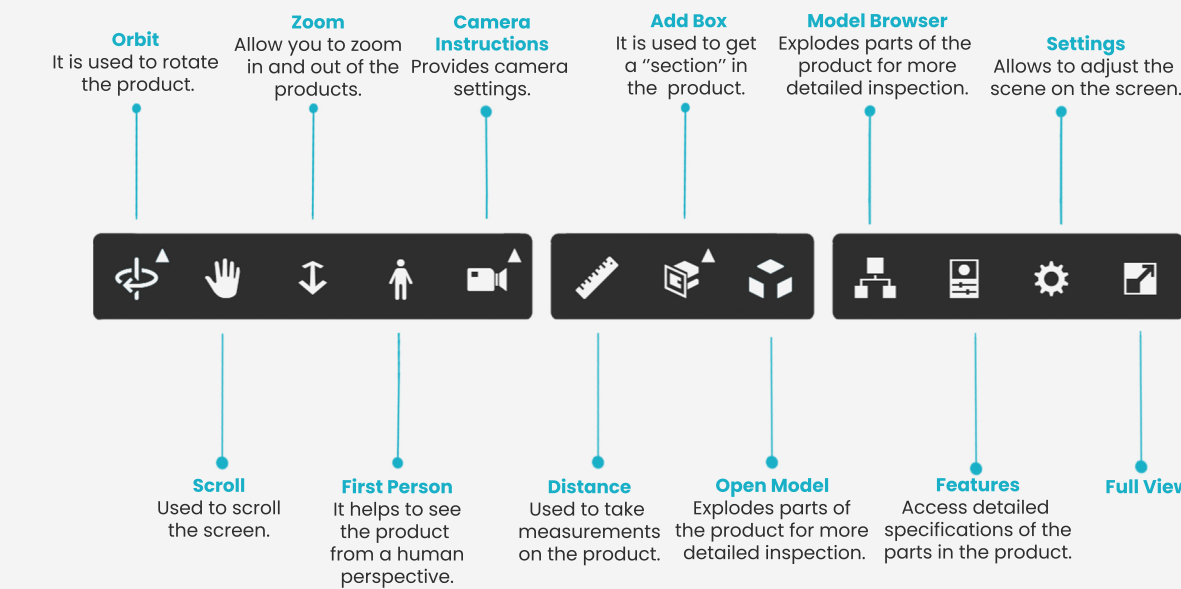

dreams come true™
Cemer

For an easy assembly stage you can scan the QR code from the assembly guide to access the 3D exploded, spare parts & details.

For Our Solutions Video Click the Link



From the menu, you can view all the details of the product and examine its spare parts.

dreams come true™
Cemer

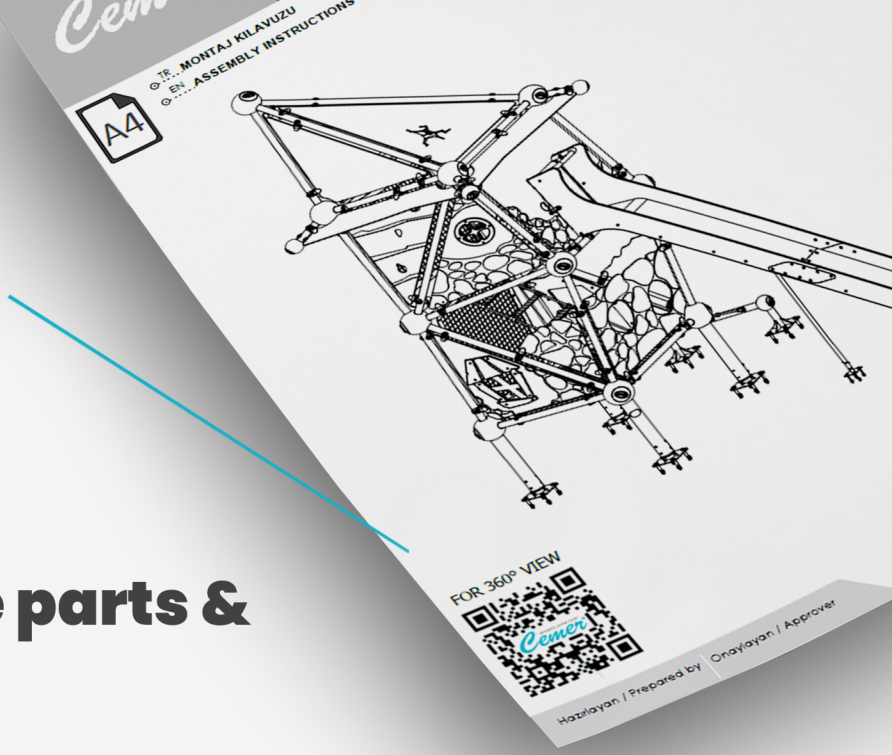

You can access the product's 360 features from your phone.



Metal Labels

As Cemer Playground Equipment, We provide professional and consistent service in production and after-sales support. Our **Lifetime Service Warranty** ensures all products are shipped or installed with metal labels containing details like production date and serial number, allowing us to easily provide

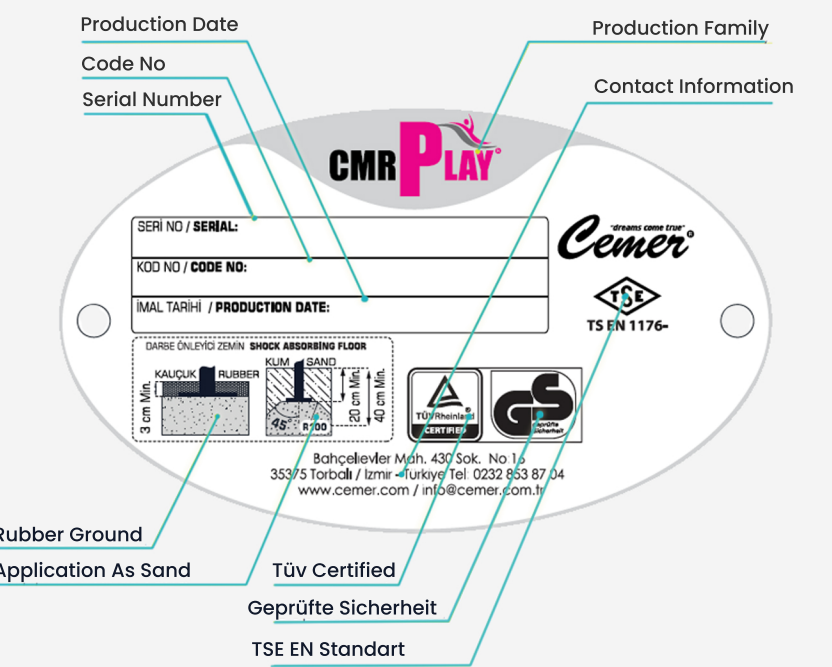

dreams come true™
Cemer

dreams come true™
exportsales@cemer.com.tr
www.cemer.com

Click and Follow us on

