

"dreams come true"
Cemer[®]



**Fast.
Communication.
Trust.**

All in One.

[All in Cemer.](#)

www.cemer.com



**Respond
quickly
within 1 week.**

**We provide spare parts
in a short time.**

Our experienced team is committed to providing quick support for any issues you encounter. We focus on timely resolutions and continuously improve our processes to ensure a seamless experience. Offering personalized solutions tailored to your needs, we aim to exceed your expectations and build a lasting, positive relationship.

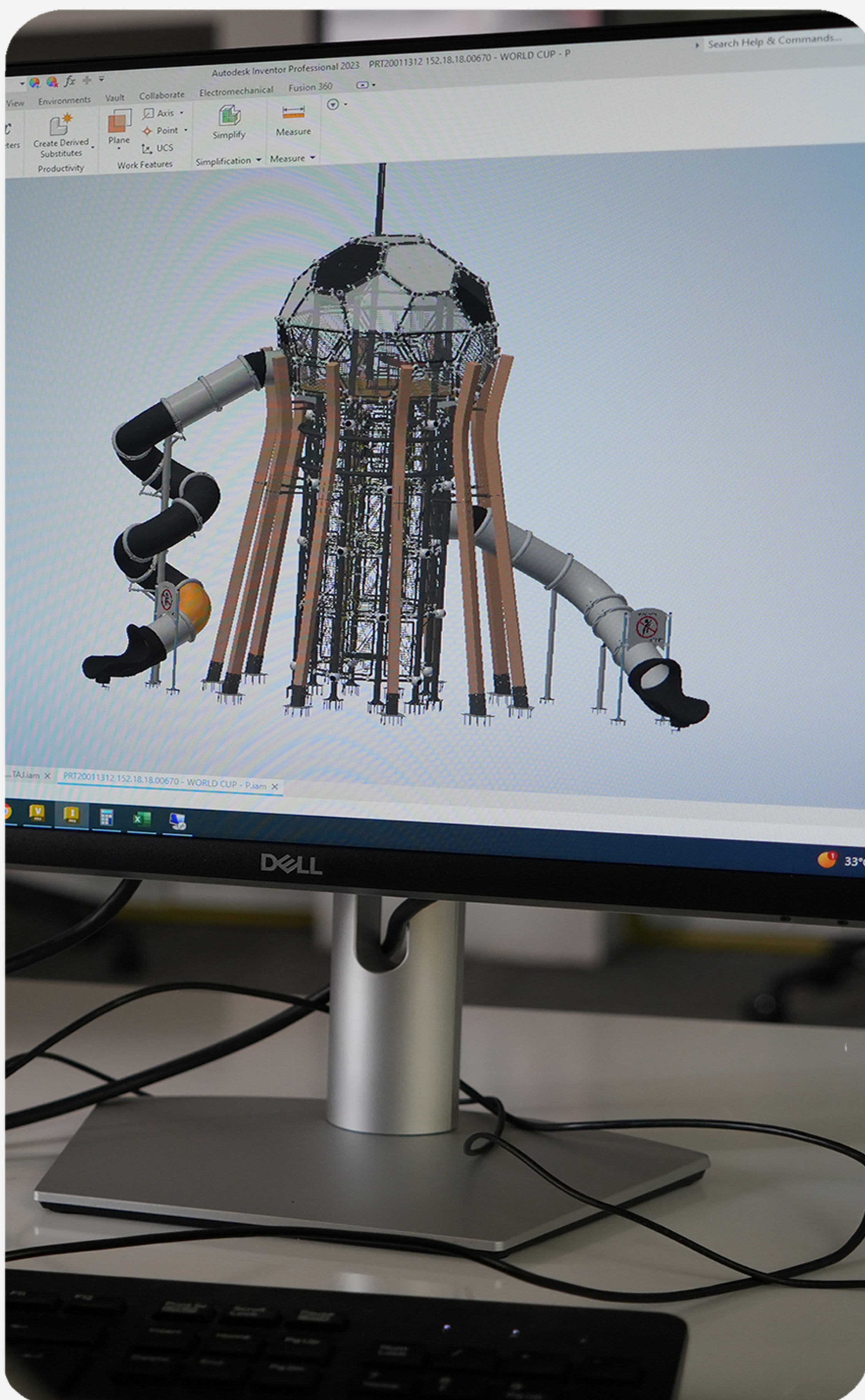

We recognize the importance of providing prompt solutions.

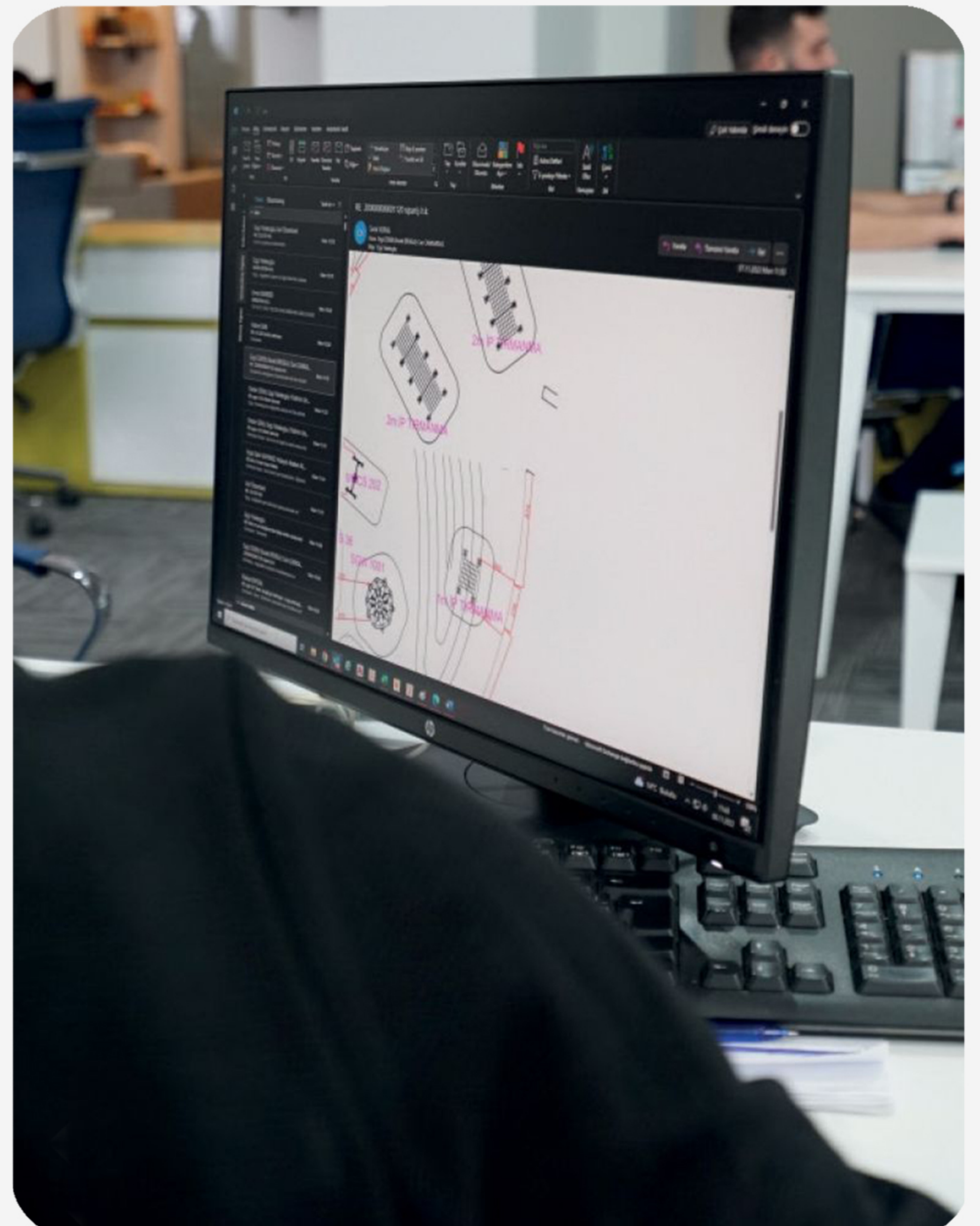

**• Opportunity
to meet one-on-one
with the designers &
engineers.**

Direct communication with designers and engineers allows for a more efficient, personalized approach. Close collaboration with product experts ensures precise solutions, faster problem-solving, and a tailored experience. Your feedback drives continuous improvement and innovation.

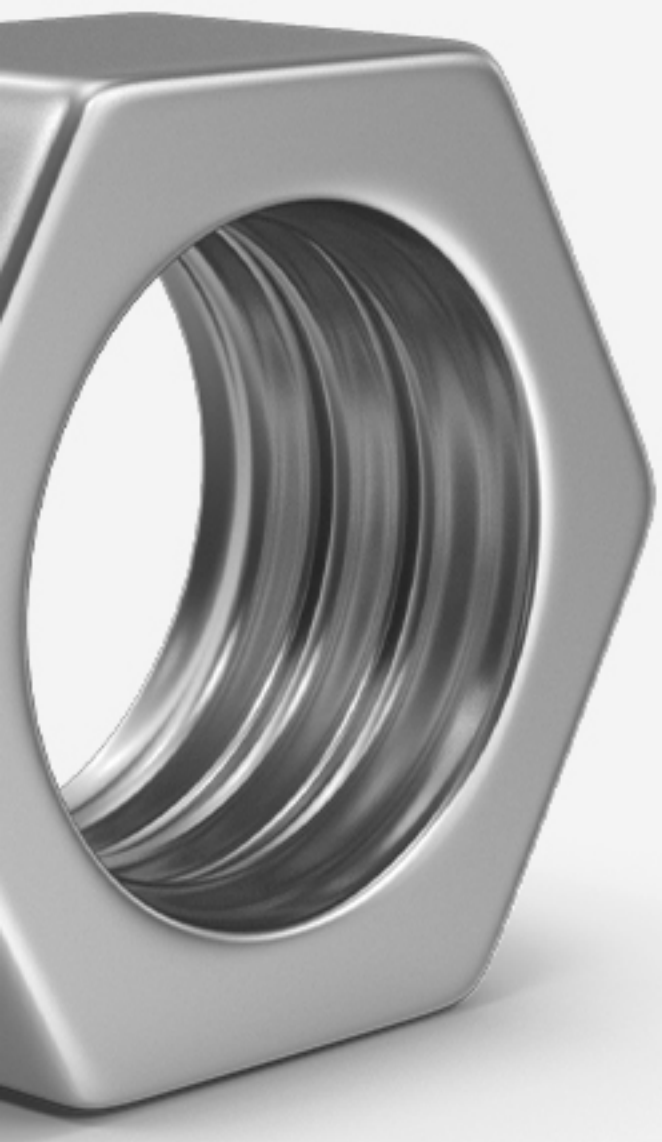

Did you know that you can even check the nut in the product you interested ?

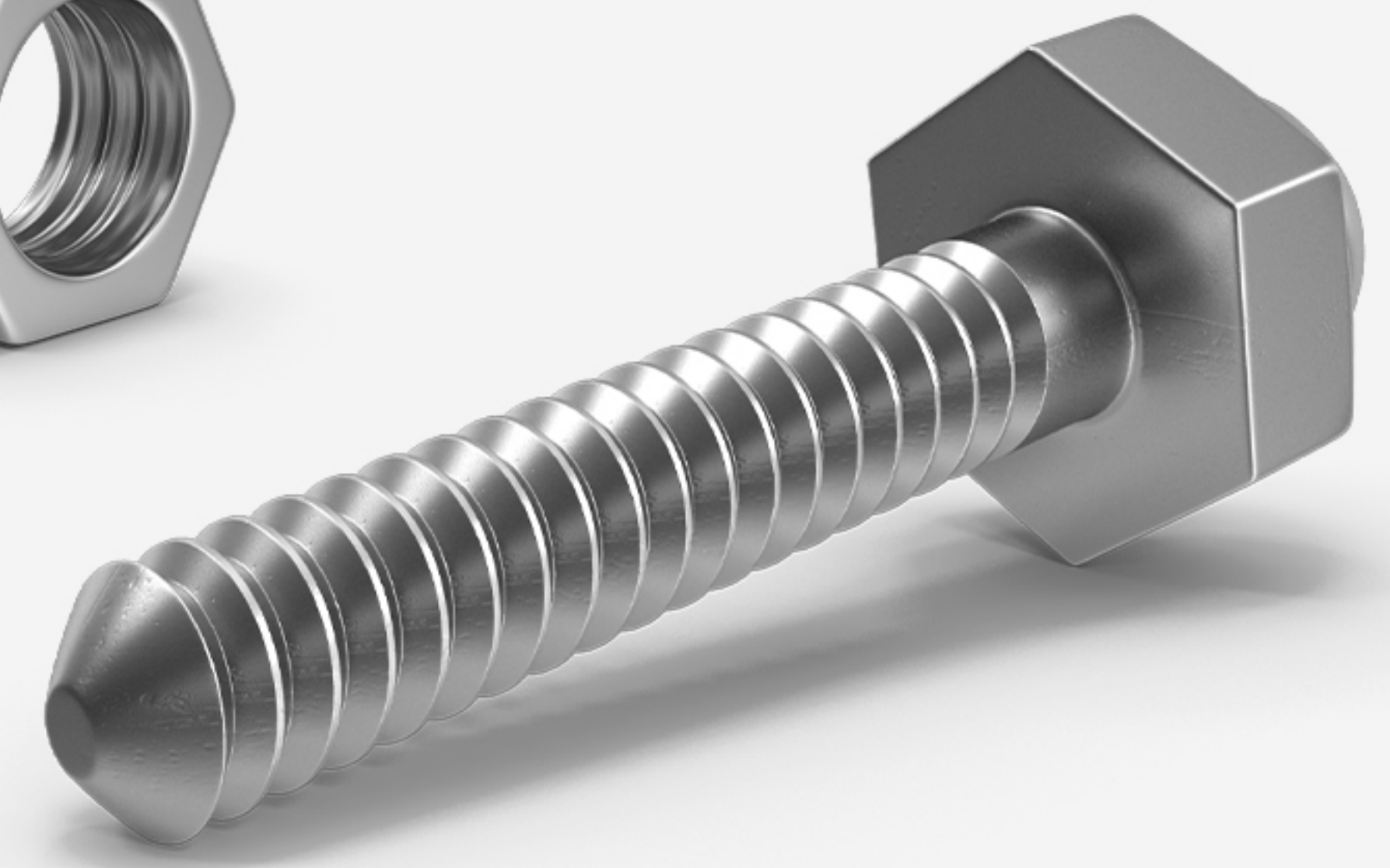
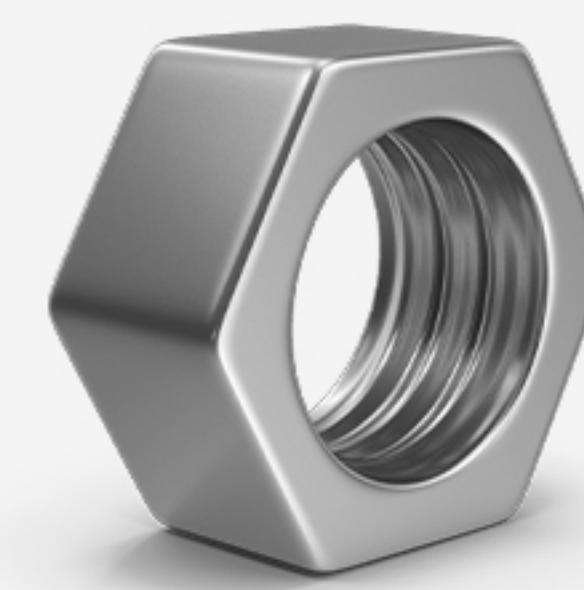

You can access all parts of the products.

You can explore the product's 360 features on both your **phone and PC**. You'll find content such as the 3D model, exploded view, spare parts.



This tool allows you to zoom in the spare part selected from the model, view it in detail and access the part code.



You can see the product's in the finest detail.



This tool allows you to view the internal structure or details of objects by breaking them into pieces.



This tool provides detailed measurements of all the parts on the product.

ACCESS MENU

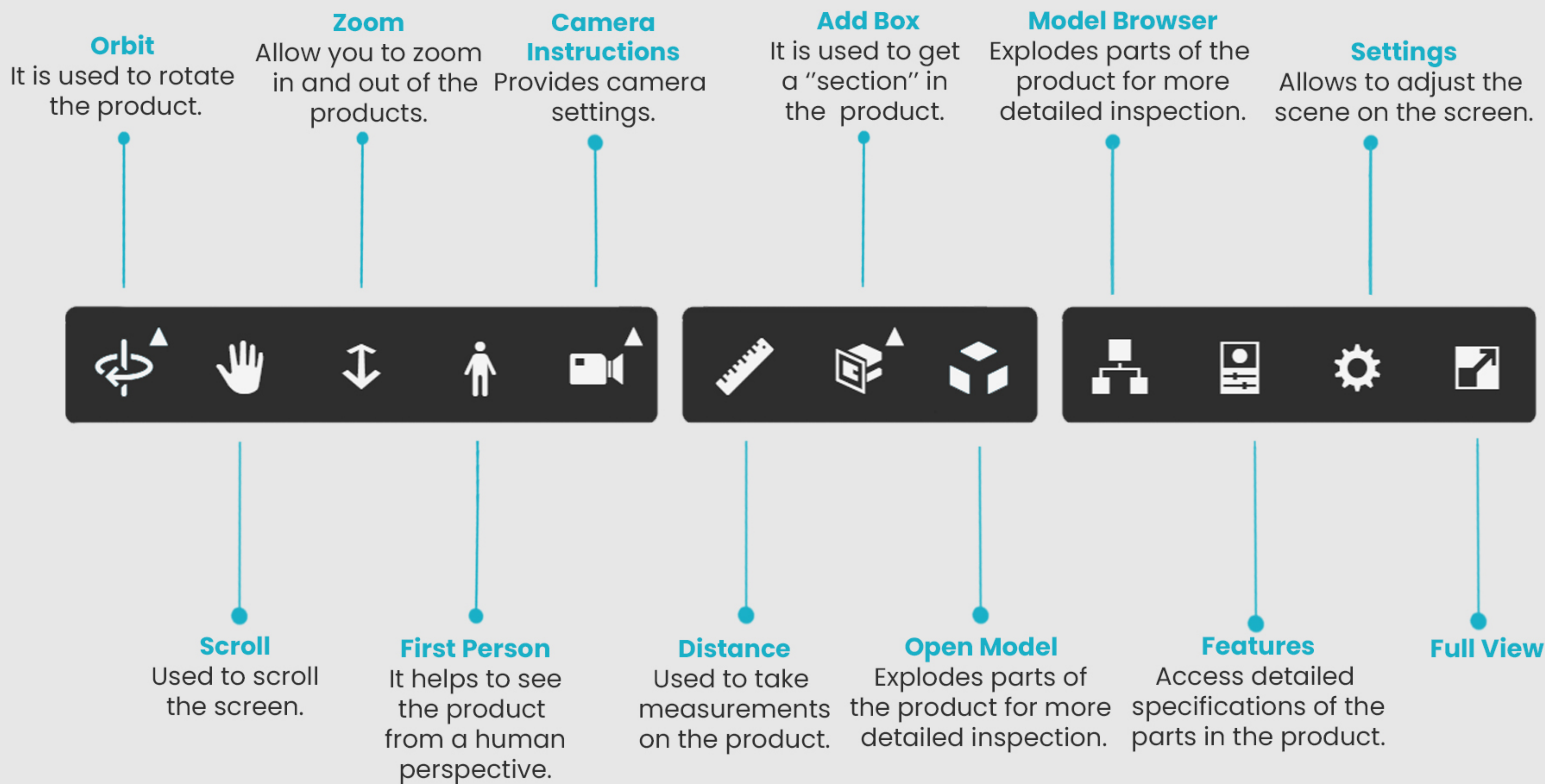

For an easy assembly stage you can scan the QR code from the assembly guide to access the 3D exploded, spare parts & details.

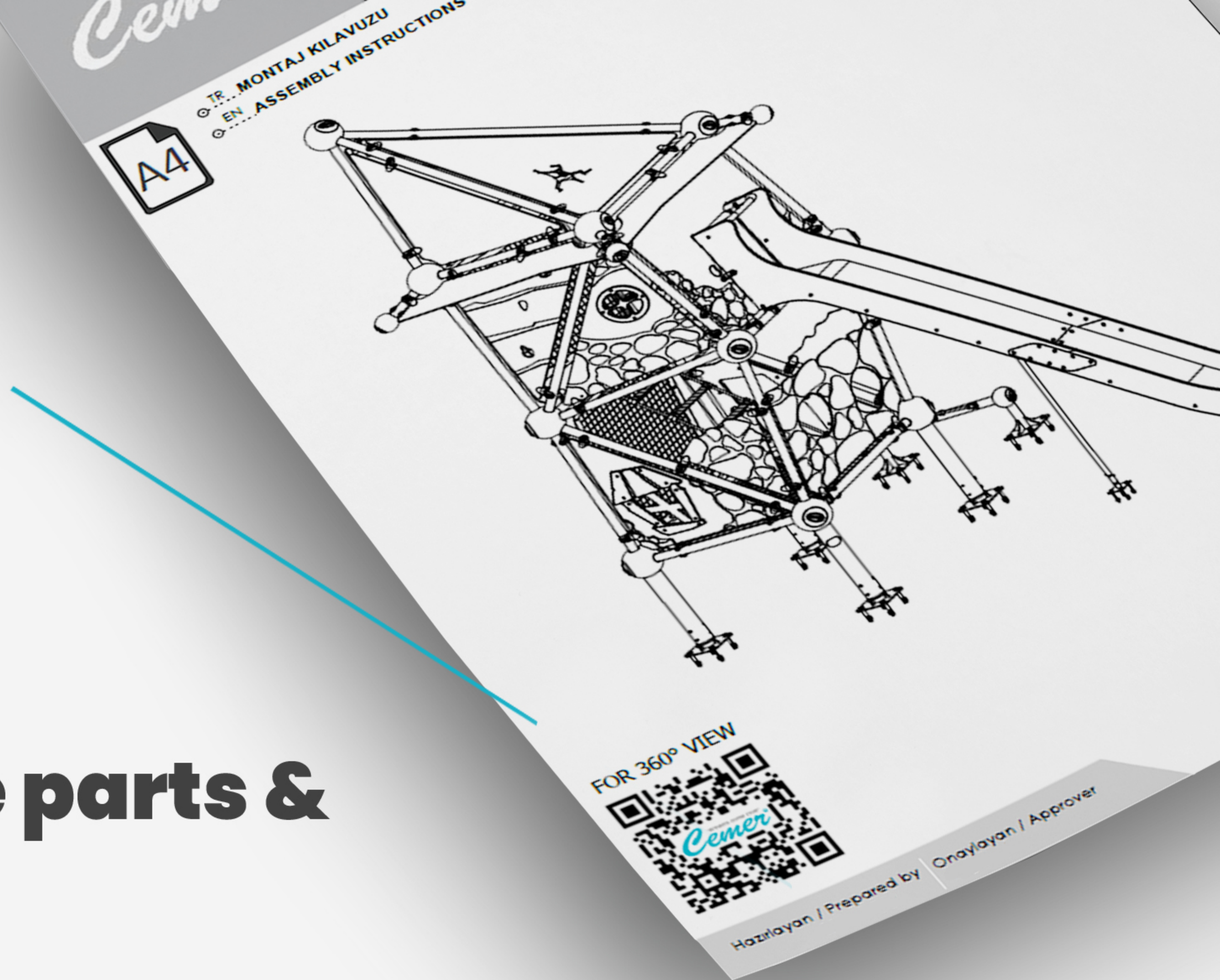

From the menu, you can view all the details of the product and examine its spare parts.



You can access the product's 360 features from your phone.

30 Years of Experience & Trust

CEMER WARRANTY

Despite the tearing and loss of strength of the steel posts.

25 YEARS

Against the breaking of steel cables, Aluminum casting materials , Other stainless steel and unpainted metal parts .

20 YEARS

HPL panels, HDPE panels, rotational plastic parts, other metal parts, composite coating, precast C25 concrete.

10 YEARS

Rusting on outer surfaces (paint), Plastic injection parts, Plywood parts, Nylon ropes against premature wear, Springs, Textile reinforced rubber mat, PVC coated platforms, High-class wooden parts, (thermowood/accoya/sapelle) Glass-fiber reinforced concrete.

5 YEARS

Nut and Bolts (Structural) Bearings Moving Plastic and Metal Parts Electronic Parts Rubber Parts Elastic-Polymer Parts 1st Class Pine and Similar Laminated Larex

2 YEARS



Metal Labels

As Cemer Playground Equipment, We provide professional and consistent service in production and after-sales support. Our [Lifetime Service Warranty](#) ensures all products are shipped or installed with metal labels containing details like production date and serial number, allowing us to easily provide parts for life.

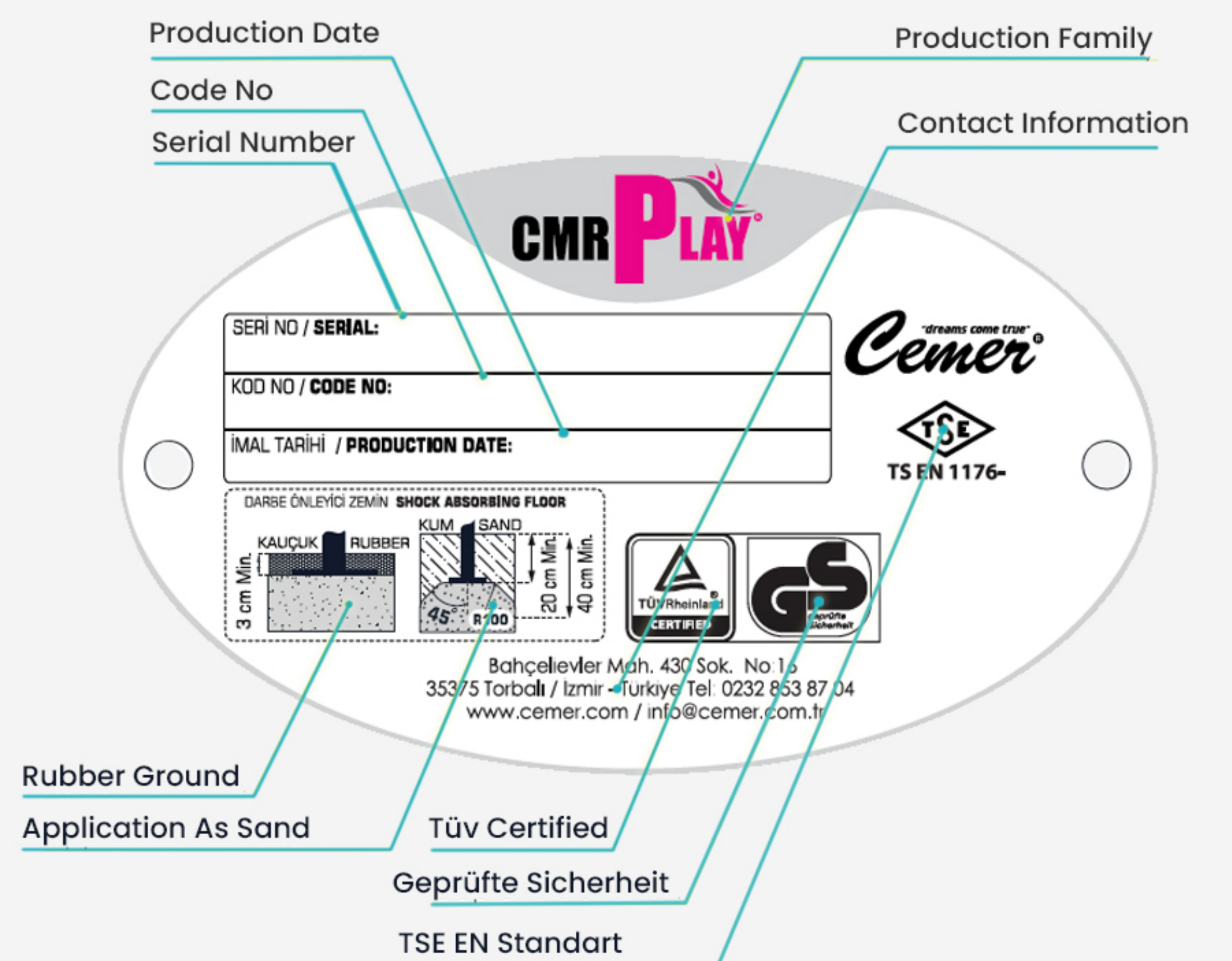

"dreams come true"
Cemer[®]

exportsales@cemer.com.tr
www.cemer.com

Follow us on



CMR **PLAY** CMR **X**TREME CMR **A**CTIVE CMR **V**RBAN CMR **H**ic CMR *idea*