

# MODERNO URBAN EQUIPMENT / ATLAS SERIES

CUS 457



Ürün Bilgisi / Product Information

Boyutlar / Dimensions (LxWxH) : 0,12x0,12x0,70 m

iii Sınırlandırıcı  
Bollard

METAL  
METAL

RAL 7021

BETON  
BETON

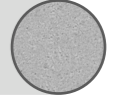

## ATLAS SERİSİ / ATLAS SERIE

**Atlas**, fonksiyonel amorf yüzeylerden oluşan ve 2 farklı tarzda beton kullanımı ile doğanın kesit görüntüsünü ürün ailesine taşıyan bir seridir. Atlas serisinde; amorf yüzeyler, malzeme olarak seçilen betonun algısını değiştiren ergonomik yüzeyler olarak kullanılmıştır. Yapısal bütünlük göz önünde bulundurulduğunda, ürün ailesinin dil birliği için, kesit görüntüsü tasarım çizgisi olarak belirlenmiş ve Atlas serisinin tüm ürünlerine taşınan bu tasarım çizgisi, kimi ürünlerde işlevsellik yerine minimalizm ön planda tutularak kullanılmıştır.

**Atlas is a series that consists of functional amorphous surfaces and carries the cross-sectional view of the nature to the product family with the use of concrete in two different styles. In Atlas series, amorphous surfaces have been used as ergonomic surfaces that change the perception of concrete selected as material. Considering the structural integrity, the cross-sectional view of the product family has been determined as the design line for the unity of the language, and this design line, which is carried to all products of the Atlas Series, is used by prioritizing the minimalism in some products instead of functionality.**



# MODERNO URBAN EQUIPMENT / ATLAS SERIES

## CUS 457

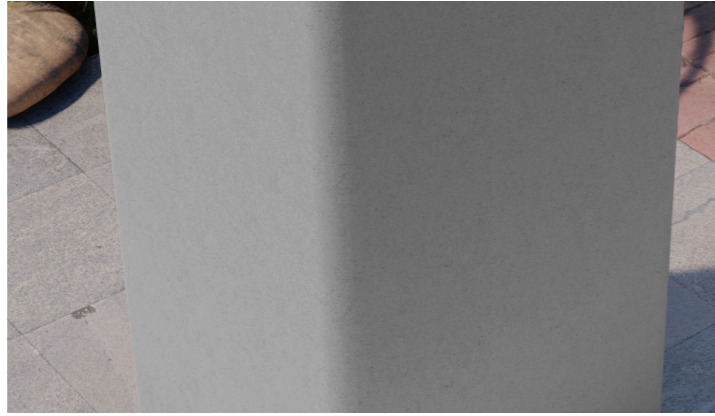

**BETON / CONCRETE GRC / GRC** Glass fiber Reinforcement Concrete (Camelyaf Takviyeli Beton) GRC; silis kumu, beyaz çimento karışımı, 10-15 mm kalınlığındaki alkaliye dayanıklı cam elyafı ve polimer katkıları olarak, özel kalıplara püskürtme suretiyle dökülmesiyle üretilen üstün özellikli betondur. Betondan daha dayanıklı ve hafiftir. Doğa koşullarından etkilenmez. Darbe ve aşınma mukavemetinin yüksektir. Su, ısı ve ses geçirgenliklerinin düşüktür. İstenirse boyanmaya elverişlidir. Hafif olmasından dolayı, montajı hızlı ve kolaydır. Yangına dayanıklıdır

**Glass fiber Reinforcement Concrete GRC; is a high quality concrete which is produced with the addition of silica sand, white cement mixture, 10-15 mm thick alkaline resistant glass fiber and polymer by casting and spraying into the special moulds. This is more durable and lighter than concrete. It is not affected by the natural conditions. Impact and wear resistance is high. The permeability of water, temperature and sound is low. If desired, it is suitable for painting. Due to its light weight, it is fast and easy to install. It is fire-resistant.**

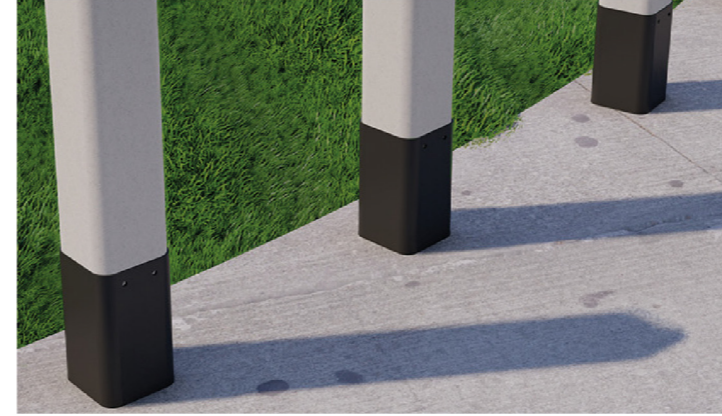

**METAL / METAL** Metal borular ve diğer metal parçalar ST 37 çelikten oluşmaktadır. Kumlama sonrası solvent içermeyen çinko-astar kaplama ve boya uygulaması ile her türlü koşulunda korozyon koruması ve UV dayanıklılığı elde edilmektedir

**Metal pipes and other metal parts are comprised of ST 37 Steel with Metal finish; Sand-blasting and treated with solvent-free zinc primer coating which is inherently corrosion resisted under extreme weather conditions and UV.**

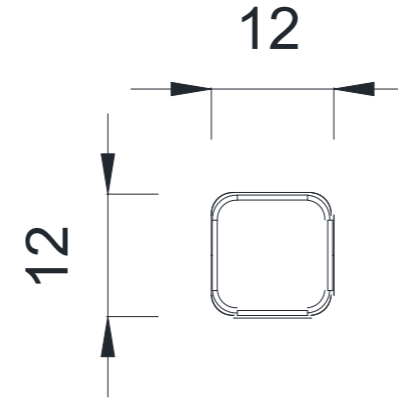
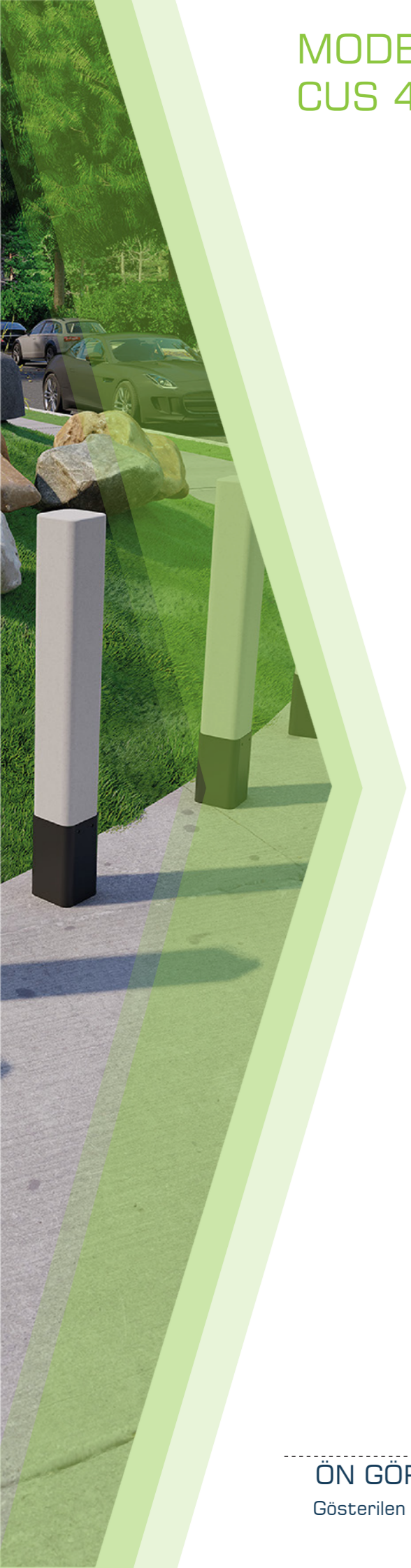

ÜST GÖRÜNÜŞ / **TOP VIEW**

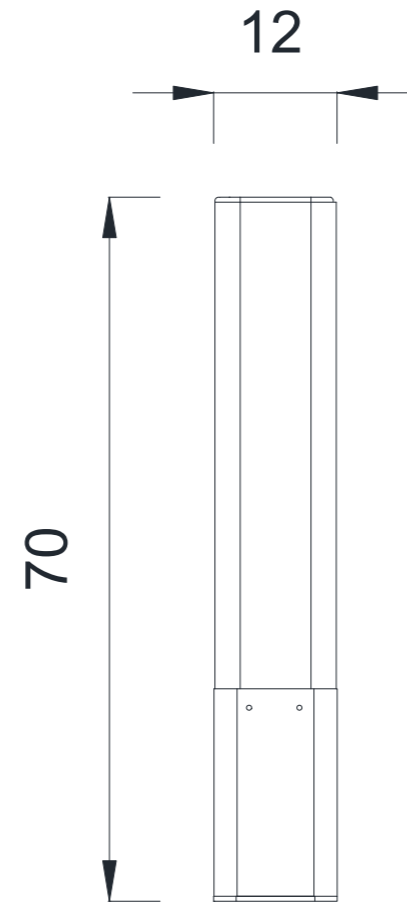

ÖN GÖRÜNÜŞ / **FRONT VIEW**

Gösterilen ölçüler cm cinsindedir / **Dimensions shown are in cm**

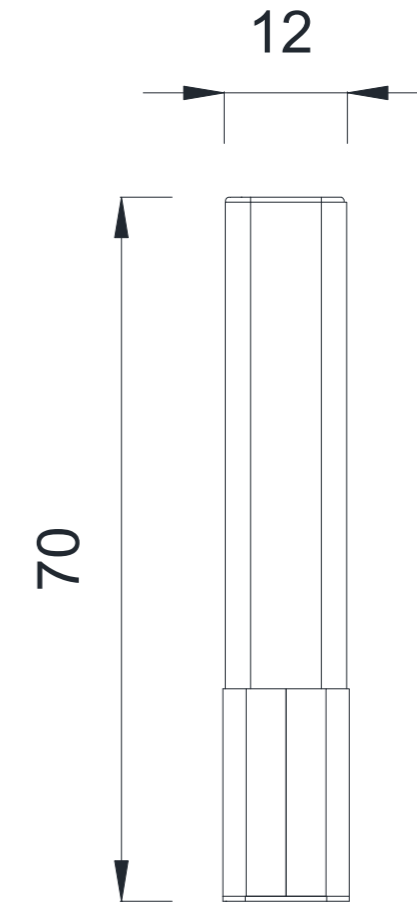

YAN GÖRÜNÜŞ / **SIDE VIEW**