

# Simulation - Dgss 18

Study name:Static 1

Analysis type:Static

## Table of Contents

Description.....	1
Assumptions .....	2
Model Information .....	2
Study Properties .....	14
Units .....	14
Material Properties .....	15
Loads and Fixtures.....	18
Connector Definitions.....	18
Contact Information.....	19
Mesh Information .....	66
Sensor Details .....	72
Resultant Forces .....	72
Beams.....	72
Study Results .....	73
Conclusion .....	76

## Description

No Data



# Assumptions

## Model Information

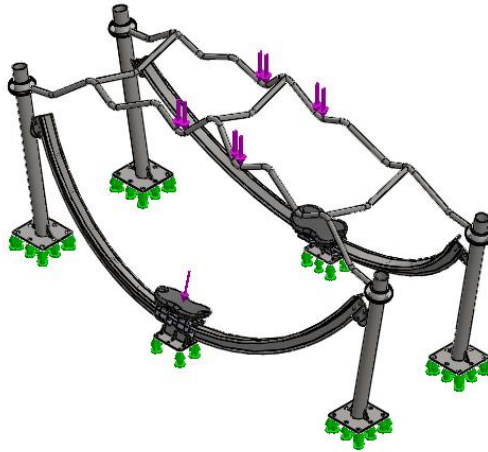

Model name: DGSS 18

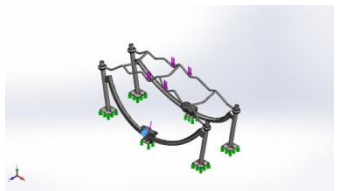
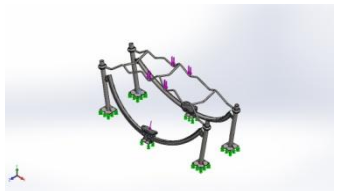
	Treated As	Volumetric Properties
<b>YüzSil4</b> 	Solid Body	Mass:2.90913 kg Volume:0.00107745 m <sup>3</sup> Density:2700 kg/m <sup>3</sup> Weight:28.5094 N
<b>Stok-css18-1</b> 	Solid Body	Mass:0.157022 kg Volume:2.01311e-005 m <sup>3</sup> Density:7800 kg/m <sup>3</sup> Weight:1.53882 N

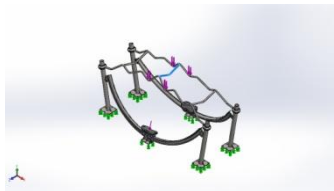
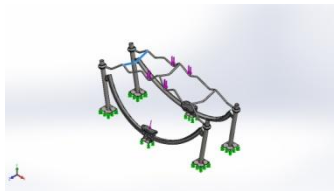
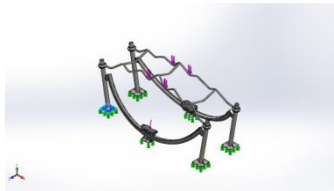
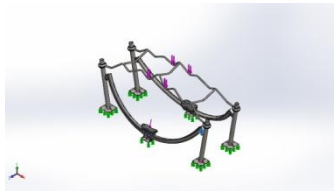
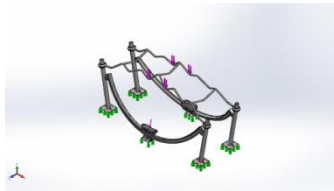
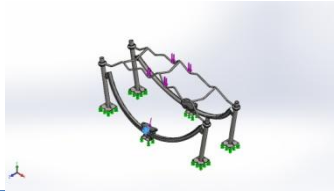
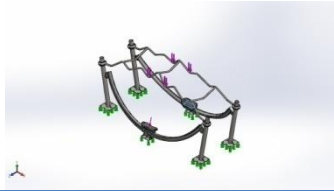
<p>Stok-css18-1</p> 	Solid Body	<p>Mass:2.84103 kg  Volume:0.000364235 m<sup>3</sup>  Density:7800 kg/m<sup>3</sup>  Weight:27.8421 N</p>
<p>Stok-css18-1</p> 	Solid Body	<p>Mass:3.28786 kg  Volume:0.00042152 m<sup>3</sup>  Density:7800 kg/m<sup>3</sup>  Weight:32.221 N</p>
<p>Stok-css18-1</p> 	Solid Body	<p>Mass:6.76145 kg  Volume:0.000866853 m<sup>3</sup>  Density:7800 kg/m<sup>3</sup>  Weight:66.2622 N</p>
<p>Stok-css18-1</p> 	Solid Body	<p>Mass:0.740589 kg  Volume:9.49473e-005 m<sup>3</sup>  Density:7800 kg/m<sup>3</sup>  Weight:7.25777 N</p>
<p>Stok-css18-1</p> 	Solid Body	<p>Mass:0.157022 kg  Volume:2.01311e-005 m<sup>3</sup>  Density:7800 kg/m<sup>3</sup>  Weight:1.53882 N</p>
<p>YüzSil4</p> 	Solid Body	<p>Mass:2.90138 kg  Volume:0.00107458 m<sup>3</sup>  Density:2700 kg/m<sup>3</sup>  Weight:28.4335 N</p>
<p>YüzSil1</p> 	Solid Body	<p>Mass:1.69863 kg  Volume:0.000217773 m<sup>3</sup>  Density:7800 kg/m<sup>3</sup>  Weight:16.6466 N</p>

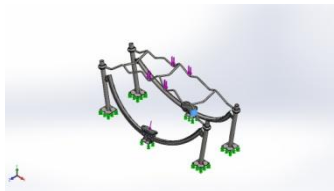
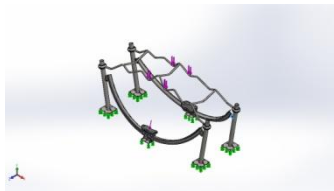
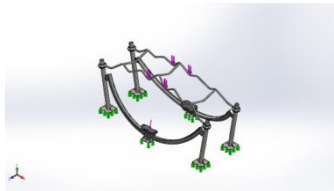
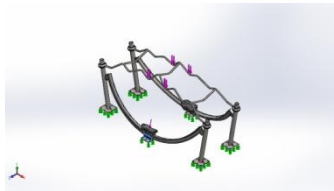
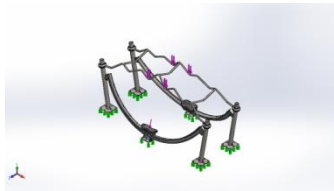
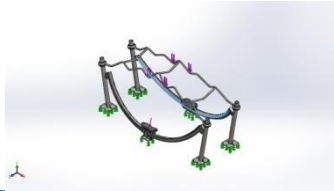
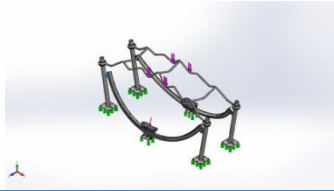
<p>YüzSil3</p> 	Solid Body	<p>Mass:2.67229 kg  Volume:0.000989736 m<sup>3</sup>  Density:2700 kg/m<sup>3</sup>  Weight:26.1884 N</p>
<p>Stok-css18-1</p> 	Solid Body	<p>Mass:0.508342 kg  Volume:6.5172e-005 m<sup>3</sup>  Density:7800 kg/m<sup>3</sup>  Weight:4.98175 N</p>
<p>Stok-css18-1</p> 	Solid Body	<p>Mass:0.12909 kg  Volume:1.655e-005 m<sup>3</sup>  Density:7800 kg/m<sup>3</sup>  Weight:1.26509 N</p>
<p>Stok-css18-1</p> 	Solid Body	<p>Mass:1.75537 kg  Volume:0.000225047 m<sup>3</sup>  Density:7800 kg/m<sup>3</sup>  Weight:17.2026 N</p>
<p>Stok-css18-1</p> 	Solid Body	<p>Mass:0.12909 kg  Volume:1.655e-005 m<sup>3</sup>  Density:7800 kg/m<sup>3</sup>  Weight:1.26509 N</p>
<p>Girinti1</p> 	Solid Body	<p>Mass:2.00403 kg  Volume:0.000256927 m<sup>3</sup>  Density:7800 kg/m<sup>3</sup>  Weight:19.6395 N</p>
<p>Stok-css18-1</p> 	Solid Body	<p>Mass:0.508342 kg  Volume:6.5172e-005 m<sup>3</sup>  Density:7800 kg/m<sup>3</sup>  Weight:4.98175 N</p>

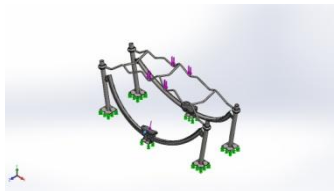
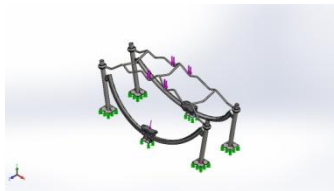
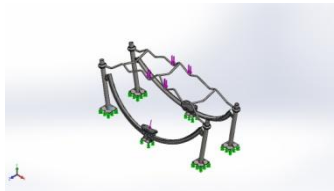
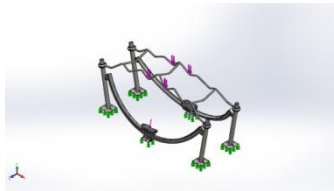
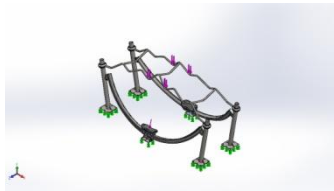
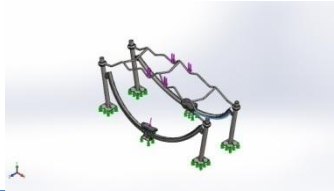
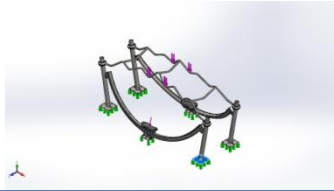
<p>Stok-css18-1</p> 	Solid Body	<p>Mass:0.0807551 kg  Volume:5.76822e-005 m<sup>3</sup>  Density:1400 kg/m<sup>3</sup>  Weight:0.7914 N</p>
<p>Stok-css18-1</p> 	Solid Body	<p>Mass:0.12909 kg  Volume:1.655e-005 m<sup>3</sup>  Density:7800 kg/m<sup>3</sup>  Weight:1.26509 N</p>
<p>Stok-css18-1</p> 	Solid Body	<p>Mass:0.157022 kg  Volume:2.01311e-005 m<sup>3</sup>  Density:7800 kg/m<sup>3</sup>  Weight:1.53882 N</p>
<p>Stok-css18-1</p> 	Solid Body	<p>Mass:0.126342 kg  Volume:1.61977e-005 m<sup>3</sup>  Density:7800 kg/m<sup>3</sup>  Weight:1.23816 N</p>
<p>Stok-css18-1</p> 	Solid Body	<p>Mass:0.12909 kg  Volume:1.655e-005 m<sup>3</sup>  Density:7800 kg/m<sup>3</sup>  Weight:1.26509 N</p>
<p>Stok-css18-1</p> 	Solid Body	<p>Mass:0.976498 kg  Volume:0.000125192 m<sup>3</sup>  Density:7800 kg/m<sup>3</sup>  Weight:9.56968 N</p>
<p>Stok-css18-1</p> 	Solid Body	<p>Mass:6.76145 kg  Volume:0.000866853 m<sup>3</sup>  Density:7800 kg/m<sup>3</sup>  Weight:66.2622 N</p>

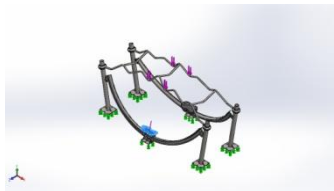
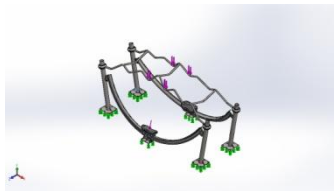
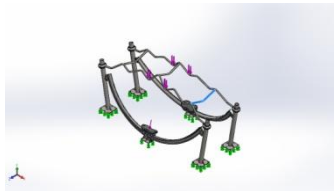
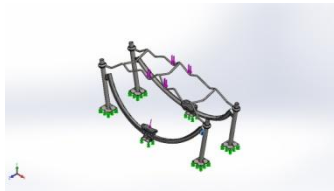
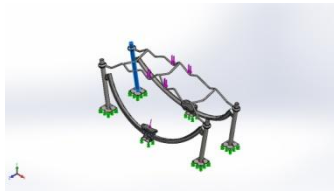
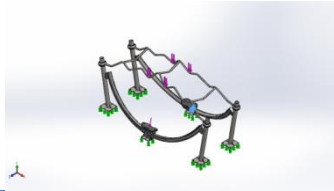
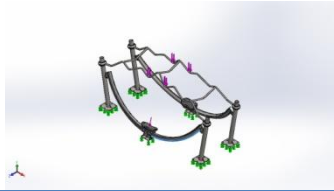
<p>YüzSil3</p> 	Solid Body	<p>Mass:5.71133 kg  Volume:0.00622827 m<sup>3</sup>  Density:917 kg/m<sup>3</sup>  Weight:55.971 N</p>
<p>Stok-css18-1</p> 	Solid Body	<p>Mass:0.160486 kg  Volume:2.05751e-005 m<sup>3</sup>  Density:7800 kg/m<sup>3</sup>  Weight:1.57276 N</p>
<p>Stok-css18-1</p> 	Solid Body	<p>Mass:3.28784 kg  Volume:0.000421519 m<sup>3</sup>  Density:7800 kg/m<sup>3</sup>  Weight:32.2209 N</p>
<p>Stok-css18-1</p> 	Solid Body	<p>Mass:0.508342 kg  Volume:6.5172e-005 m<sup>3</sup>  Density:7800 kg/m<sup>3</sup>  Weight:4.98175 N</p>
<p>Stok-css18-1</p> 	Solid Body	<p>Mass:20.0883 kg  Volume:0.00257542 m<sup>3</sup>  Density:7800 kg/m<sup>3</sup>  Weight:196.865 N</p>
<p>YüzSil2</p> 	Solid Body	<p>Mass:2.66875 kg  Volume:0.000988426 m<sup>3</sup>  Density:2700 kg/m<sup>3</sup>  Weight:26.1537 N</p>
<p>Stok-css18-1</p> 	Solid Body	<p>Mass:0.976415 kg  Volume:0.000125181 m<sup>3</sup>  Density:7800 kg/m<sup>3</sup>  Weight:9.56886 N</p>

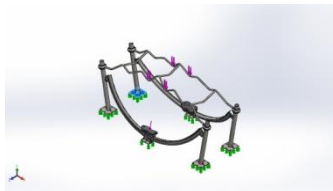
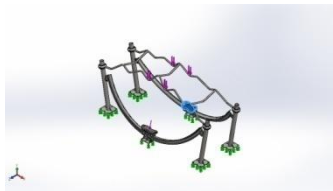
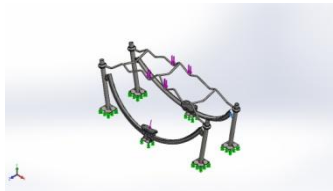
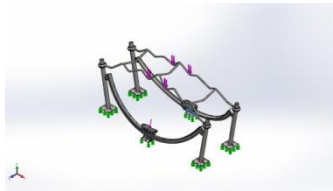
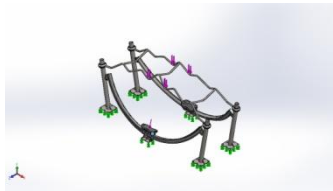
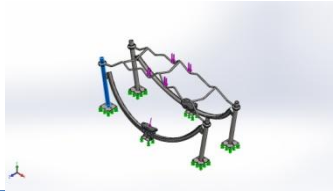
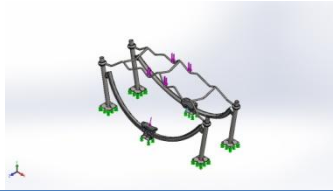
<p>Stok-css18-1</p> 	Solid Body	<p>Mass:6.76145 kg  Volume:0.000866853 m<sup>3</sup>  Density:7800 kg/m<sup>3</sup>  Weight:66.2622 N</p>
<p>YüzSil3</p> 	Solid Body	<p>Mass:5.71145 kg  Volume:0.00622841 m<sup>3</sup>  Density:917 kg/m<sup>3</sup>  Weight:55.9723 N</p>
<p>Stok-css18-1</p> 	Solid Body	<p>Mass:0.740589 kg  Volume:9.49473e-005 m<sup>3</sup>  Density:7800 kg/m<sup>3</sup>  Weight:7.25777 N</p>
<p>Girinti1</p> 	Solid Body	<p>Mass:1.75495 kg  Volume:0.000224994 m<sup>3</sup>  Density:7800 kg/m<sup>3</sup>  Weight:17.1985 N</p>
<p>Stok-css18-1</p> 	Solid Body	<p>Mass:0.0807551 kg  Volume:5.76822e-005 m<sup>3</sup>  Density:1400 kg/m<sup>3</sup>  Weight:0.7914 N</p>
<p>Stok-css18-1</p> 	Solid Body	<p>Mass:20.0888 kg  Volume:0.00257549 m<sup>3</sup>  Density:7800 kg/m<sup>3</sup>  Weight:196.871 N</p>
<p>Stok-css18-1</p> 	Solid Body	<p>Mass:0.12909 kg  Volume:1.655e-005 m<sup>3</sup>  Density:7800 kg/m<sup>3</sup>  Weight:1.26509 N</p>

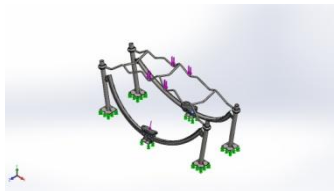
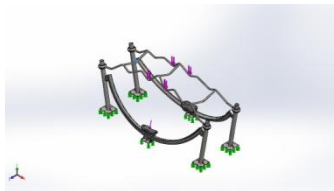
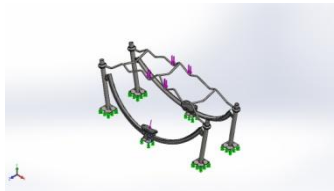
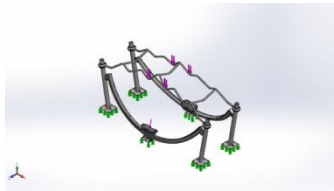
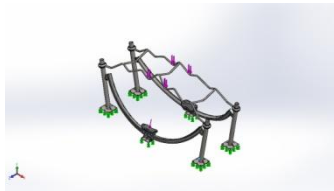
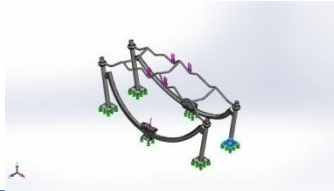
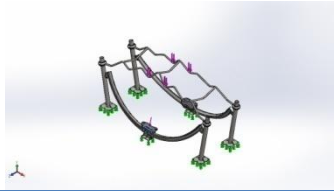
<p>Stok-css18-1</p> 	Solid Body	<p>Mass:0.155742 kg  Volume:5.76822e-005 m<sup>3</sup>  Density:2700 kg/m<sup>3</sup>  Weight:1.52627 N</p>
<p>Stok-css18-1</p> 	Solid Body	<p>Mass:0.508342 kg  Volume:6.5172e-005 m<sup>3</sup>  Density:7800 kg/m<sup>3</sup>  Weight:4.98175 N</p>
<p>Stok-css18-1</p> 	Solid Body	<p>Mass:0.126342 kg  Volume:1.61977e-005 m<sup>3</sup>  Density:7800 kg/m<sup>3</sup>  Weight:1.23816 N</p>
<p>Stok-css18-1</p> 	Solid Body	<p>Mass:0.160486 kg  Volume:2.05751e-005 m<sup>3</sup>  Density:7800 kg/m<sup>3</sup>  Weight:1.57276 N</p>
<p>Stok-css18-1</p> 	Solid Body	<p>Mass:0.157022 kg  Volume:2.01311e-005 m<sup>3</sup>  Density:7800 kg/m<sup>3</sup>  Weight:1.53882 N</p>
<p>Stok-css18-1</p> 	Solid Body	<p>Mass:6.76145 kg  Volume:0.000866853 m<sup>3</sup>  Density:7800 kg/m<sup>3</sup>  Weight:66.2622 N</p>
<p>YüzSil1</p> 	Solid Body	<p>Mass:1.69863 kg  Volume:0.000217773 m<sup>3</sup>  Density:7800 kg/m<sup>3</sup>  Weight:16.6466 N</p>

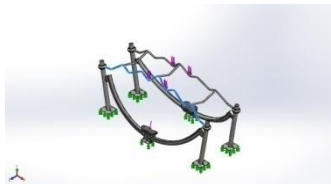
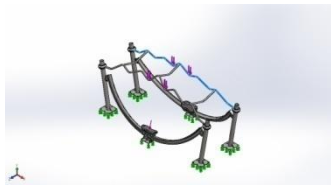
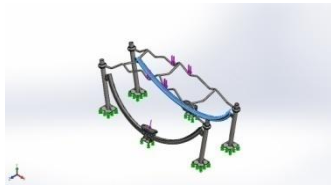
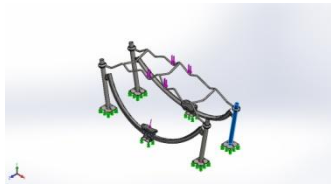
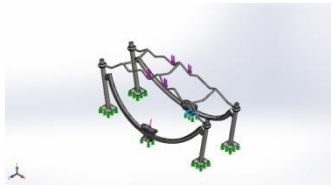
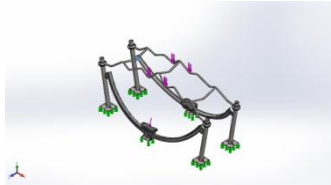
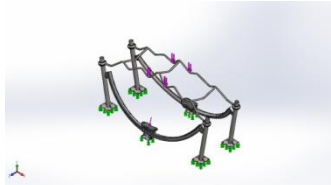

<p>Girinti2</p> 	<p>Solid Body</p>	<p>Mass:15.3782 kg Volume:0.00197156 m<sup>3</sup> Density:7800 kg/m<sup>3</sup> Weight:150.706 N</p>
<p>Girinti2</p> 	<p>Solid Body</p>	<p>Mass:15.3783 kg Volume:0.00197158 m<sup>3</sup> Density:7800 kg/m<sup>3</sup> Weight:150.707 N</p>
<p>Girinti1</p> 	<p>Solid Body</p>	<p>Mass:46.9539 kg Volume:0.00601973 m<sup>3</sup> Density:7800 kg/m<sup>3</sup> Weight:460.148 N</p>
<p>Stok-css18-1</p> 	<p>Solid Body</p>	<p>Mass:20.0883 kg Volume:0.00257542 m<sup>3</sup> Density:7800 kg/m<sup>3</sup> Weight:196.865 N</p>
<p>Stok-css18-1</p> 	<p>Solid Body</p>	<p>Mass:2.24125 kg Volume:0.00028734 m<sup>3</sup> Density:7800 kg/m<sup>3</sup> Weight:21.9643 N</p>
<p>Stok-css18-1</p> 	<p>Solid Body</p>	<p>Mass:0.740589 kg Volume:9.49473e-005 m<sup>3</sup> Density:7800 kg/m<sup>3</sup> Weight:7.25777 N</p>
<p>Stok-css18-1</p> 	<p>Solid Body</p>	<p>Mass:0.126342 kg Volume:1.61977e-005 m<sup>3</sup> Density:7800 kg/m<sup>3</sup> Weight:1.23816 N</p>

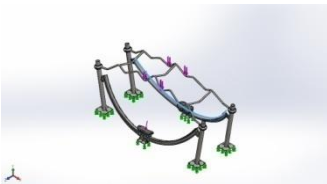
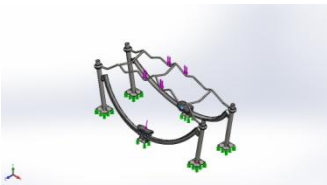
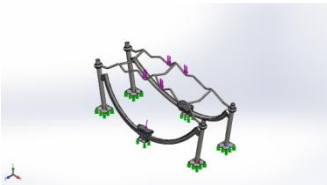
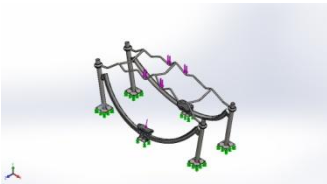
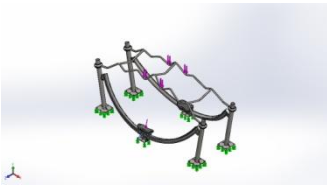
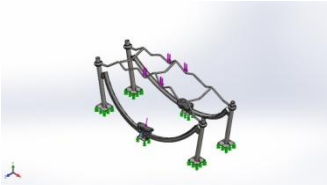
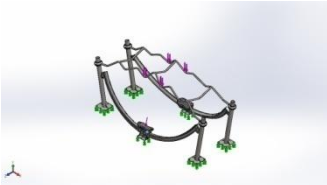
<p>Girinti1</p> 	<p>Solid Body</p>	<p>Mass:1.92871 kg Volume:0.00024727 m<sup>3</sup> Density:7800 kg/m<sup>3</sup> Weight:18.9013 N</p>
<p>Stok-css18-1</p> 	<p>Solid Body</p>	<p>Mass:0.0807551 kg Volume:5.76822e-005 m<sup>3</sup> Density:1400 kg/m<sup>3</sup> Weight:0.7914 N</p>
<p>Stok-css18-1</p> 	<p>Solid Body</p>	<p>Mass:0.160486 kg Volume:2.05751e-005 m<sup>3</sup> Density:7800 kg/m<sup>3</sup> Weight:1.57276 N</p>
<p>Stok-css18-1</p> 	<p>Solid Body</p>	<p>Mass:0.160486 kg Volume:2.05751e-005 m<sup>3</sup> Density:7800 kg/m<sup>3</sup> Weight:1.57276 N</p>
<p>Stok-css18-1</p> 	<p>Solid Body</p>	<p>Mass:0.126342 kg Volume:1.61977e-005 m<sup>3</sup> Density:7800 kg/m<sup>3</sup> Weight:1.23816 N</p>
<p>Stok-css18-1</p> 	<p>Solid Body</p>	<p>Mass:0.12909 kg Volume:1.655e-005 m<sup>3</sup> Density:7800 kg/m<sup>3</sup> Weight:1.26509 N</p>
<p>Stok-css18-1</p> 	<p>Solid Body</p>	<p>Mass:0.0807551 kg Volume:5.76822e-005 m<sup>3</sup> Density:1400 kg/m<sup>3</sup> Weight:0.7914 N</p>

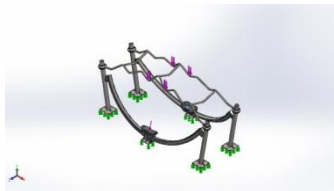
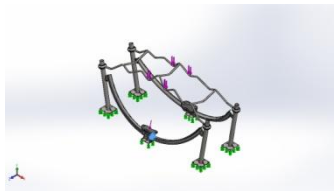
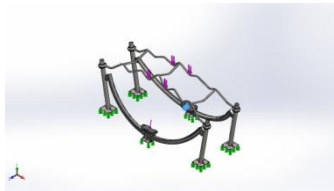
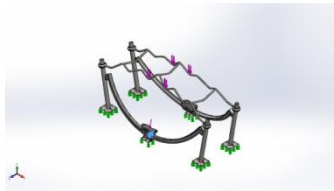
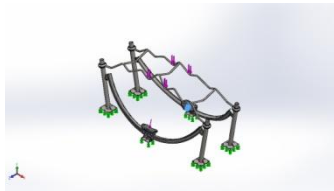
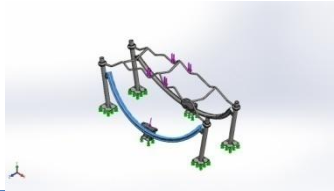
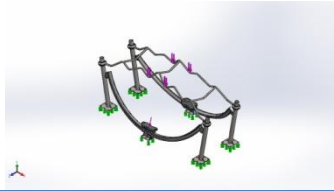
<p>YüzSil1</p> 	Solid Body	<p>Mass:0.0817018 kg  Volume:5.83584e-005 m<sup>3</sup>  Density:1400 kg/m<sup>3</sup>  Weight:0.800678 N</p>
<p>YüzSil6</p> 	Solid Body	<p>Mass:2.90807 kg  Volume:0.00107706 m<sup>3</sup>  Density:2700 kg/m<sup>3</sup>  Weight:28.4991 N</p>
<p>YüzSil6</p> 	Solid Body	<p>Mass:2.90807 kg  Volume:0.00107706 m<sup>3</sup>  Density:2700 kg/m<sup>3</sup>  Weight:28.4991 N</p>
<p>YüzSil10</p> 	Solid Body	<p>Mass:2.90895 kg  Volume:0.00107739 m<sup>3</sup>  Density:2700 kg/m<sup>3</sup>  Weight:28.5077 N</p>
<p>YüzSil4</p> 	Solid Body	<p>Mass:2.66876 kg  Volume:0.000988428 m<sup>3</sup>  Density:2700 kg/m<sup>3</sup>  Weight:26.1538 N</p>
<p>Girinti1</p> 	Solid Body	<p>Mass:46.9528 kg  Volume:0.00601959 m<sup>3</sup>  Density:7800 kg/m<sup>3</sup>  Weight:460.137 N</p>
<p>Stok-css18-1</p> 	Solid Body	<p>Mass:0.126342 kg  Volume:1.61977e-005 m<sup>3</sup>  Density:7800 kg/m<sup>3</sup>  Weight:1.23816 N</p>

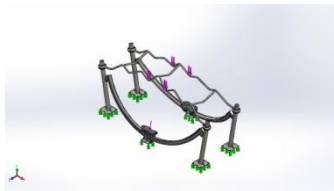
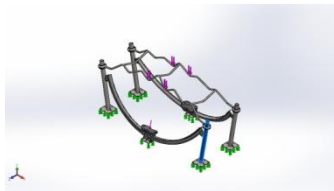
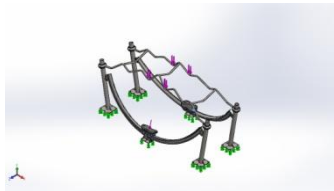
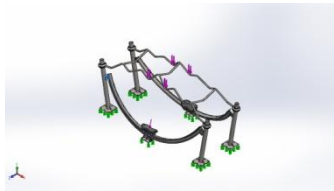
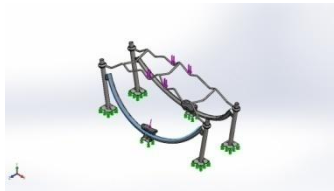
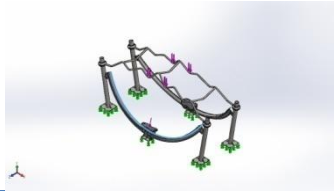
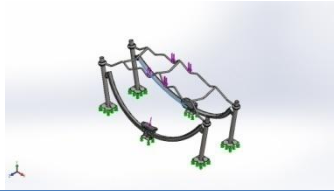
<p>Stok-css18-1</p> 	Solid Body	<p>Mass:0.126342 kg  Volume:1.61977e-005 m<sup>3</sup>  Density:7800 kg/m<sup>3</sup>  Weight:1.23816 N</p>
<p>Stok-css18-1</p> 	Solid Body	<p>Mass:20.0888 kg  Volume:0.00257549 m<sup>3</sup>  Density:7800 kg/m<sup>3</sup>  Weight:196.87 N</p>
<p>Stok-css18-1</p> 	Solid Body	<p>Mass:0.0807551 kg  Volume:5.76822e-005 m<sup>3</sup>  Density:1400 kg/m<sup>3</sup>  Weight:0.7914 N</p>
<p>Stok-css18-1</p> 	Solid Body	<p>Mass:0.740589 kg  Volume:9.49473e-005 m<sup>3</sup>  Density:7800 kg/m<sup>3</sup>  Weight:7.25777 N</p>
<p>Girinti1</p> 	Solid Body	<p>Mass:1.92863 kg  Volume:0.00024726 m<sup>3</sup>  Density:7800 kg/m<sup>3</sup>  Weight:18.9006 N</p>
<p>Girinti1</p> 	Solid Body	<p>Mass:2.00396 kg  Volume:0.000256918 m<sup>3</sup>  Density:7800 kg/m<sup>3</sup>  Weight:19.6388 N</p>
<p>Stok-css18-1</p> 	Solid Body	<p>Mass:0.976415 kg  Volume:0.000125181 m<sup>3</sup>  Density:7800 kg/m<sup>3</sup>  Weight:9.56886 N</p>

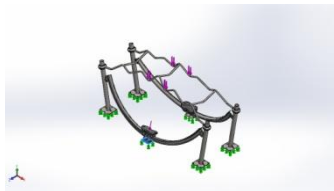
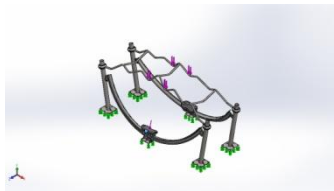
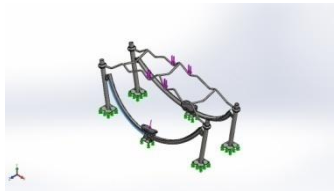
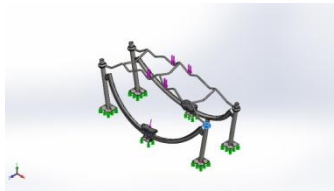
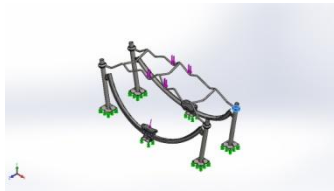
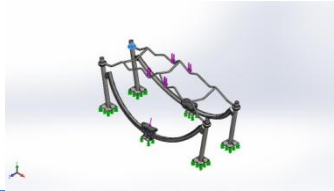
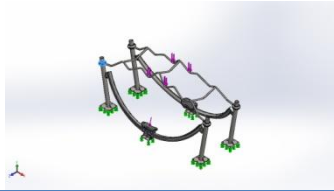
<p>Stok-css18-1</p> 	Solid Body	<p>Mass:2.24125 kg  Volume:0.00028734 m<sup>3</sup>  Density:7800 kg/m<sup>3</sup>  Weight:21.9643 N</p>
<p>Stok-css18-1</p> 	Solid Body	<p>Mass:0.0807551 kg  Volume:5.76822e-005 m<sup>3</sup>  Density:1400 kg/m<sup>3</sup>  Weight:0.7914 N</p>
<p>Stok-css18-1</p> 	Solid Body	<p>Mass:0.976498 kg  Volume:0.000125192 m<sup>3</sup>  Density:7800 kg/m<sup>3</sup>  Weight:9.56968 N</p>
<p>Girinti1</p> 	Solid Body	<p>Mass:2.91956 kg  Volume:0.0020854 m<sup>3</sup>  Density:1400 kg/m<sup>3</sup>  Weight:28.6117 N</p>
<p>Girinti1</p> 	Solid Body	<p>Mass:2.91956 kg  Volume:0.0020854 m<sup>3</sup>  Density:1400 kg/m<sup>3</sup>  Weight:28.6117 N</p>
<p>Girinti1</p> 	Solid Body	<p>Mass:2.91956 kg  Volume:0.0020854 m<sup>3</sup>  Density:1400 kg/m<sup>3</sup>  Weight:28.6117 N</p>
<p>Girinti1</p> 	Solid Body	<p>Mass:2.91956 kg  Volume:0.0020854 m<sup>3</sup>  Density:1400 kg/m<sup>3</sup>  Weight:28.6117 N</p>

## Study Properties

Study name	Static 1
Analysis type	Static
Mesh type	Solid Mesh
Thermal Effect:	On
Thermal option	Include temperature loads
Zero strain temperature	298 Kelvin
Include fluid pressure effects from SolidWorks Flow Simulation	Off
Solver type	FFEPlus
Inplane Effect:	Off
Soft Spring:	Off
Inertial Relief:	Off
Incompatible bonding options	Automatic
Large displacement	Off
Compute free body forces	On
Friction	Off
Use Adaptive Method:	Off

## Units

Unit system:	SI (MKS)
Length/Displacement	mm
Temperature	Kelvin
Angular velocity	Rad/sec
Pressure/Stress	N/mm <sup>2</sup> (MPa)

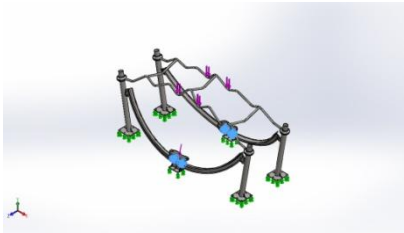
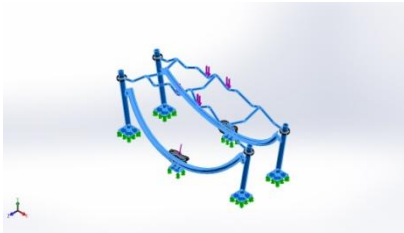

## Material Properties

Model Reference	Properties	Components
	<p> <b>Name:</b> 6061 Alaşım  <b>Model type:</b> Linear Elastic Isotropic  <b>Default failure criterion:</b> Max von Mises Stress  <b>Yield strength:</b> 55.1485 N/mm<sup>2</sup>  <b>Tensile strength:</b> 124.084 N/mm<sup>2</sup>  <b>Elastic modulus:</b> 69000 N/mm<sup>2</sup>  <b>Poisson's ratio:</b> 0.33  <b>Mass density:</b> 2700 g/cm<sup>3</sup>  <b>Shear modulus:</b> 26000 N/mm<sup>2</sup>  <b>Thermal expansion coefficient:</b> 2.4e-005 /Kelvin         </p>	<p>           SolidBody 1(YüzSil4)(4FE-1),            SolidBody 1(YüzSil4)(543-1),            SolidBody 1(YüzSil3)(547-1),            SolidBody 1(YüzSil2)(58C-1),            SolidBody 1(Stok-css18-1)(5CA-1),            SolidBody 1(YüzSil6)(688-1),            SolidBody 1(YüzSil6)(688-2),            SolidBody 1(YüzSil10)(689-1),            SolidBody 1(YüzSil4)(68E-1)         </p>
Curve Data:N/A		
	<p> <b>Name:</b> 1.0037 (S235JR)  <b>Model type:</b> Linear Elastic Isotropic  <b>Default failure criterion:</b> Max von Mises Stress  <b>Yield strength:</b> 235 N/mm<sup>2</sup>  <b>Tensile strength:</b> 360 N/mm<sup>2</sup>  <b>Elastic modulus:</b> 210000 N/mm<sup>2</sup>  <b>Poisson's ratio:</b> 0.28  <b>Mass density:</b> 7800 g/cm<sup>3</sup>  <b>Shear modulus:</b> 79000 N/mm<sup>2</sup>  <b>Thermal expansion coefficient:</b> 1.1e-005 /Kelvin         </p>	<p>           SolidBody 1(Stok-css18-1)(4FF-1),            SolidBody 1(Stok-css18-1)(505-1),            SolidBody 1(Stok-css18-1)(506-1),            SolidBody 1(Stok-css18-1)(513-1),            SolidBody 1(Stok-css18-1)(51C-1),            SolidBody 1(Stok-css18-1)(53F-1),            SolidBody 1(YüzSil1)(546-1),            SolidBody 1(Stok-css18-1)(548-1),            SolidBody 1(Stok-css18-1)(549-1),            SolidBody 1(Stok-css18-1)(54A-1),            SolidBody 1(Stok-css18-1)(54F-1),            SolidBody 1(Girinti1)(553-1),            SolidBody 1(Stok-css18-1)(557-1),            SolidBody 1(Stok-css18-1)(560-1),            SolidBody 1(Stok-css18-1)(561-1),            SolidBody 1(Stok-css18-1)(565-1),            SolidBody 1(Stok-css18-1)(566-1),            SolidBody 1(Stok-css18-1)(568-1),            SolidBody 1(Stok-css18-         </p>

		1)(569-1), SolidBody 1(Stok-css18-1)(57B-1), SolidBody 1(Stok-css18-1)(581-1), SolidBody 1(Stok-css18-1)(583-1), SolidBody 1(Stok-css18-1)(587-1), SolidBody 1(Stok-css18-1)(597-1), SolidBody 1(Stok-css18-1)(598-1), SolidBody 1(Stok-css18-1)(5A1-1), SolidBody 1(Girinti1)(5A5-1), SolidBody 1(Stok-css18-1)(5C1-1), SolidBody 1(Stok-css18-1)(5C4-1), SolidBody 1(Stok-css18-1)(5CB-1), SolidBody 1(Stok-css18-1)(5E2-1), SolidBody 1(Stok-css18-1)(5EA-1), SolidBody 1(Stok-css18-1)(5EE-1), SolidBody 1(Stok-css18-1)(5F1-1), SolidBody 1(YüzSil1)(5F2-1), SolidBody 1(Girinti2)(5F8-1), SolidBody 1(Girinti2)(5FB-1), SolidBody 1(Girinti1)(608-1), SolidBody 1(Stok-css18-1)(611-1), SolidBody 1(Stok-css18-1)(615-1), SolidBody 1(Stok-css18-1)(61C-1), SolidBody 1(Stok-css18-1)(61D-1), SolidBody 1(Girinti1)(626-1), SolidBody 1(Stok-css18-1)(639-1), SolidBody 1(Stok-css18-1)(64F-1), SolidBody 1(Stok-css18-1)(663-1), SolidBody 1(Stok-css18-1)(667-1), SolidBody 1(Girinti1)(69D-1), SolidBody 1(Stok-css18-1)(6AA-1), SolidBody 1(Stok-css18-
--	--	--



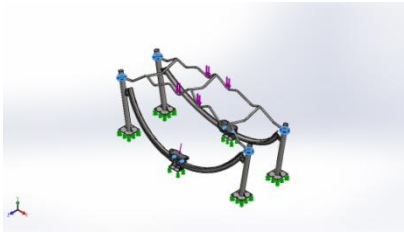
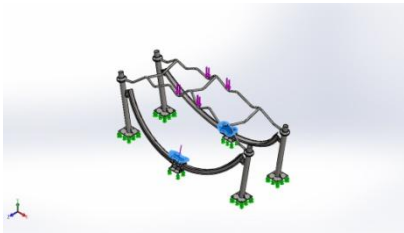

		1)(6AB-1), SolidBody 1(Stok-css18-1)(6B0-1), SolidBody 1(Stok-css18-1)(6BF-1), SolidBody 1(Girinti1)(6CD-1), SolidBody 1(Girinti1)(6D6-1), SolidBody 1(Stok-css18-1)(6E0-1), SolidBody 1(Stok-css18-1)(6E5-1), SolidBody 1(Stok-css18-1)(Alınmış34-1)
Curve Data:N/A		
	<b>Name:</b> Nylon 6/10 <b>Model type:</b> Linear Elastic Isotropic <b>Default failure criterion:</b> Max von Mises Stress <b>Yield strength:</b> 139.043 N/mm <sup>2</sup> <b>Tensile strength:</b> 142.559 N/mm <sup>2</sup> <b>Elastic modulus:</b> 8300 N/mm <sup>2</sup> <b>Poisson's ratio:</b> 0.28 <b>Mass density:</b> 1400 g/cm <sup>3</sup> <b>Shear modulus:</b> 3200 N/mm <sup>2</sup> <b>Thermal expansion coefficient:</b> 3e-005 /Kelvin	SolidBody 1(Stok-css18-1)(55A-1), SolidBody 1(Stok-css18-1)(5B3-1), SolidBody 1(Stok-css18-1)(633-1), SolidBody 1(Stok-css18-1)(67A-1), SolidBody 1(YüzSil1)(683-1), SolidBody 1(Stok-css18-1)(6BA-1), SolidBody 1(Stok-css18-1)(702-1), SolidBody 1(Girinti1)(BAGLANTI-1), SolidBody 1(Girinti1)(BAGLANTI-2), SolidBody 1(Girinti1)(BAGLANTI-3), SolidBody 1(Girinti1)(BAGLANTI-4)
Curve Data:N/A		
	<b>Name:</b> PE Düşük/Orta Yoğunluk <b>Model type:</b> Linear Elastic Isotropic <b>Default failure criterion:</b> Unknown <b>Tensile strength:</b> 13.27 N/mm <sup>2</sup> <b>Elastic modulus:</b> 172 N/mm <sup>2</sup> <b>Poisson's ratio:</b> 0.439 <b>Mass density:</b> 917 g/cm <sup>3</sup> <b>Shear modulus:</b> 59.4 N/mm <sup>2</sup>	SolidBody 1(YüzSil3)(578-1), SolidBody 1(YüzSil3)(599-1)
Curve Data:N/A		

## Loads and Fixtures

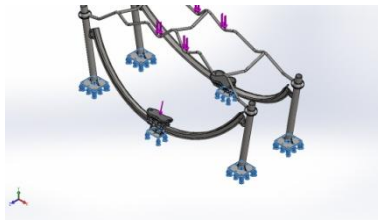
Fixture name	Fixture Image	Fixture Details		
Fixed-2		<b>Entities:</b> 6 face(s) <b>Type:</b> Fixed Geometry		
Resultant Forces				
Components	X	Y	Z	Resultant
Reaction force(N)	1.68618	3333.39	-0.631949	3333.39
Reaction Moment(N.m)	0	0	0	0

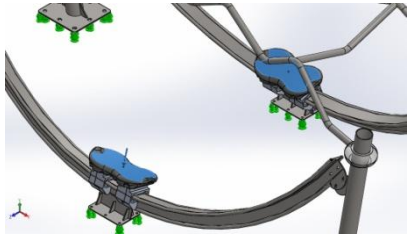
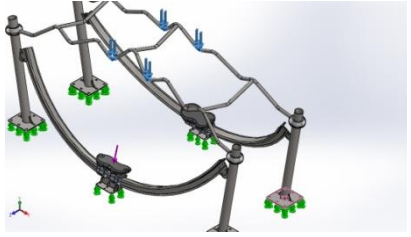
Load name	Load Image	Load Details
Kuvvet-1		<b>Entities:</b> 2 face(s) <b>Type:</b> Apply normal force <b>Value:</b> 1000 N
Kuvvet-2		<b>Entities:</b> 4 face(s) <b>Reference:</b> Face< 1 > <b>Type:</b> Apply force <b>Values:</b> 350 N

## Connector Definitions

No Data

## Contact Information

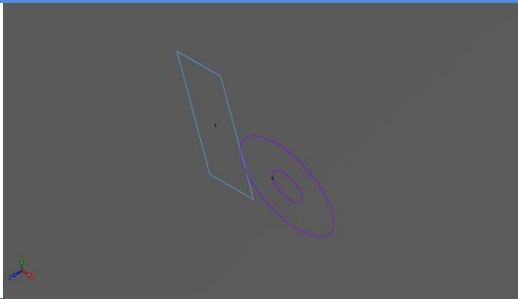
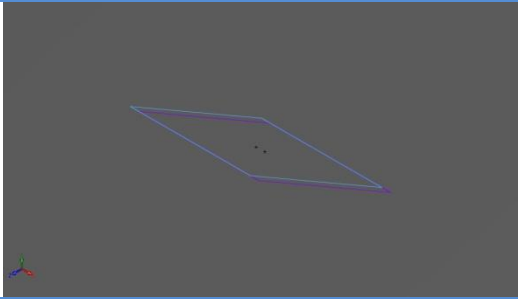
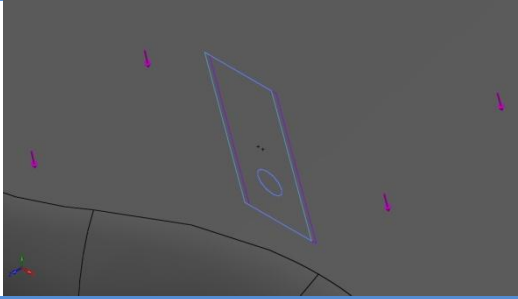
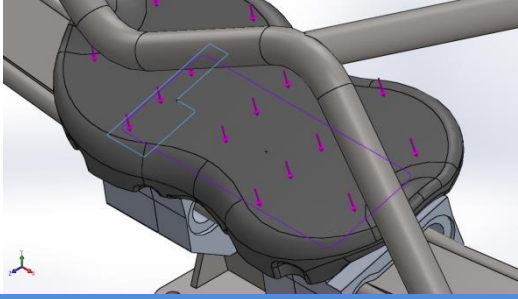
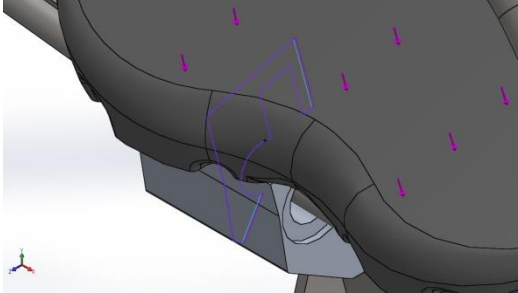
Contact	Contact Image	Contact Properties
Temas Seti-1		<p><b>Type:</b> Bonded contact pair</p> <p><b>Entites:</b> 2 face(s)</p>
Temas Seti-2		<p><b>Type:</b> Bonded contact pair</p> <p><b>Entites:</b> 2 face(s)</p>
Temas Seti-3		<p><b>Type:</b> Bonded contact pair</p> <p><b>Entites:</b> 2 face(s)</p>
Temas Seti-4		<p><b>Type:</b> Bonded contact pair</p> <p><b>Entites:</b> 2 face(s)</p>
Temas Seti-5		<p><b>Type:</b> Bonded contact pair</p> <p><b>Entites:</b> 2 face(s)</p>

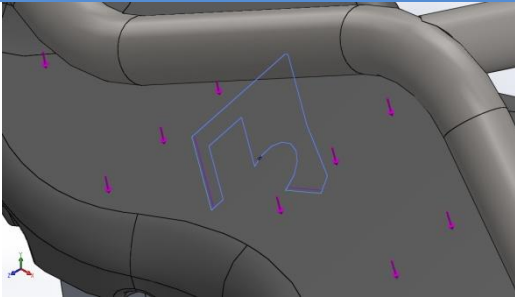
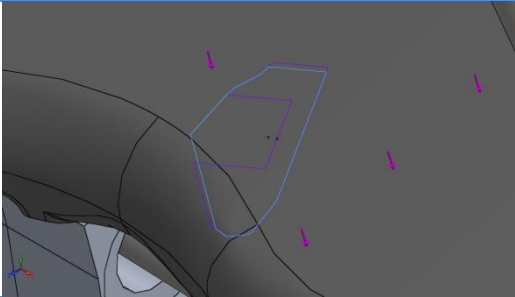
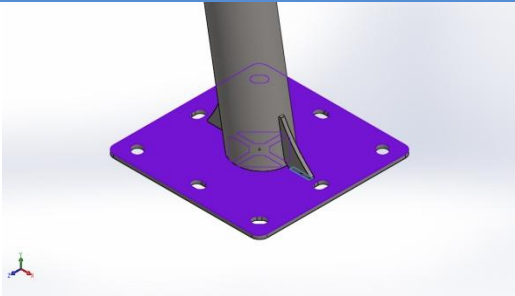
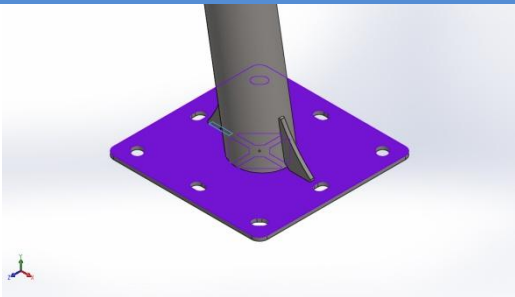
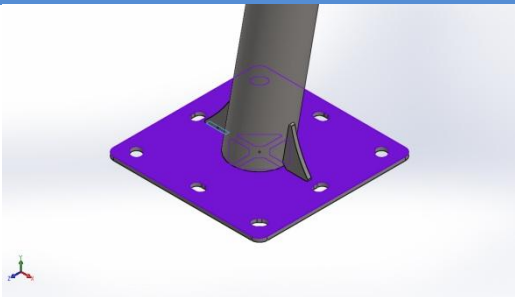

<p>Temas Seti-6</p>		<p><b>Type:</b> Bonded contact pair <b>Entites:</b> 2 face(s)</p>
<p>Temas Seti-7</p>		<p><b>Type:</b> Bonded contact pair <b>Entites:</b> 2 face(s)</p>
<p>Temas Seti-8</p>		<p><b>Type:</b> Bonded contact pair <b>Entites:</b> 2 face(s)</p>
<p>Temas Seti-9</p>		<p><b>Type:</b> Bonded contact pair <b>Entites:</b> 2 face(s)</p>
<p>Temas Seti-10</p>		<p><b>Type:</b> Bonded contact pair <b>Entites:</b> 2 face(s)</p>

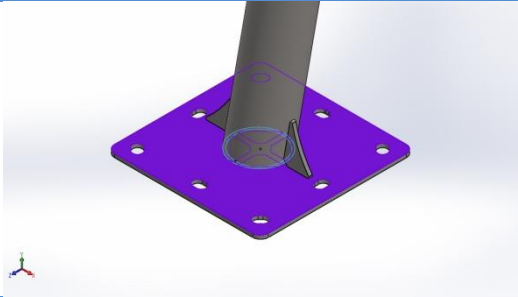
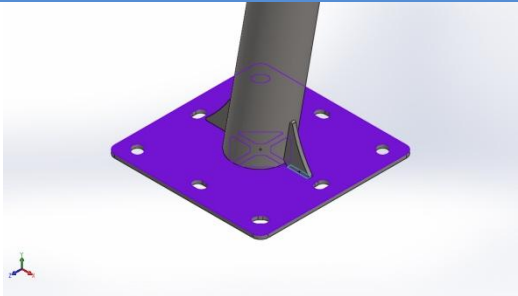
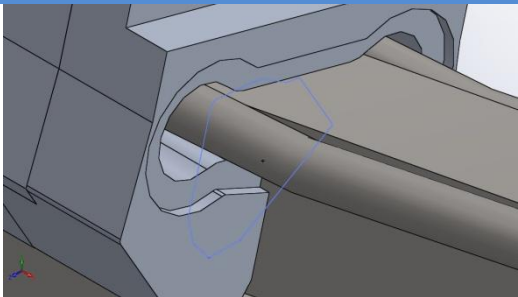
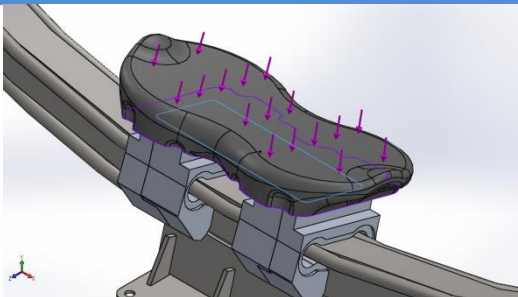
<p>Temas Seti-11</p>		<p><b>Type:</b> Bonded contact pair  <b>Entites:</b> 2 face(s)</p>
<p>Temas Seti-12</p>		<p><b>Type:</b> Bonded contact pair  <b>Entites:</b> 2 face(s)</p>
<p>Temas Seti-13</p>		<p><b>Type:</b> Bonded contact pair  <b>Entites:</b> 2 face(s)</p>
<p>Temas Seti-14</p>		<p><b>Type:</b> Bonded contact pair  <b>Entites:</b> 2 face(s)</p>
<p>Temas Seti-15</p>		<p><b>Type:</b> Bonded contact pair  <b>Entites:</b> 2 face(s)</p>

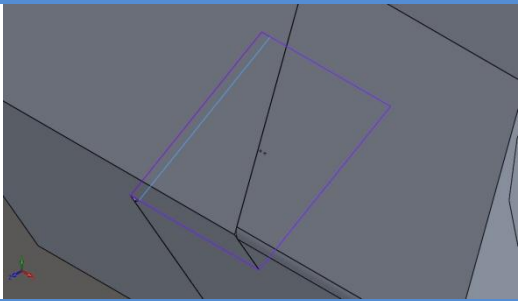
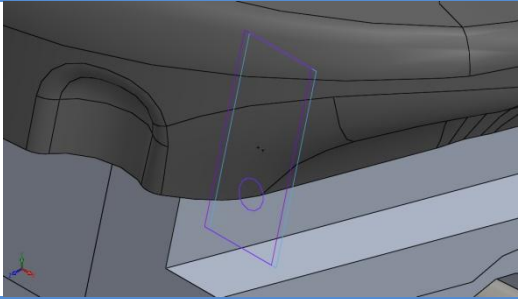
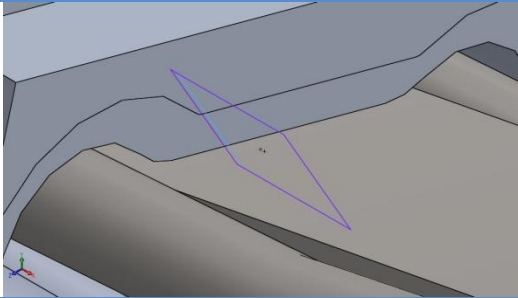
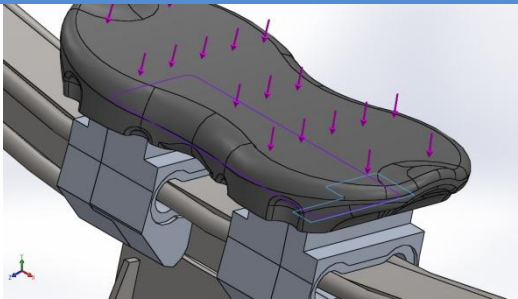
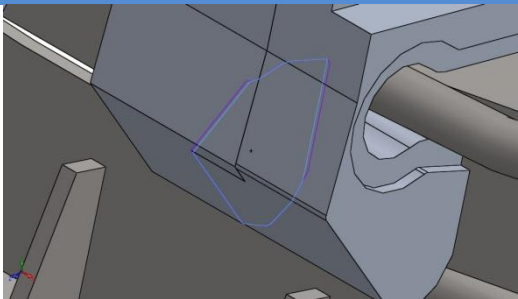
<p>Temas Seti-16</p>		<p><b>Type:</b> Bonded contact pair <b>Entites:</b> 2 face(s)</p>
<p>Temas Seti-17</p>		<p><b>Type:</b> Bonded contact pair <b>Entites:</b> 2 face(s)</p>
<p>Temas Seti-18</p>		<p><b>Type:</b> Bonded contact pair <b>Entites:</b> 2 face(s)</p>
<p>Temas Seti-19</p>		<p><b>Type:</b> Bonded contact pair <b>Entites:</b> 2 face(s)</p>
<p>Temas Seti-20</p>		<p><b>Type:</b> Bonded contact pair <b>Entites:</b> 2 face(s)</p>

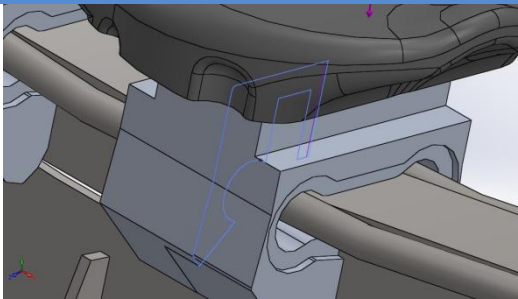
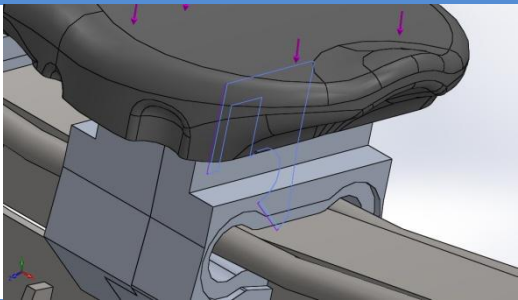
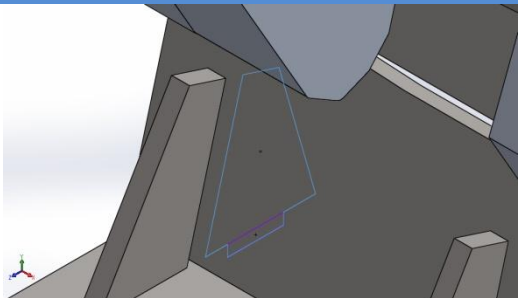
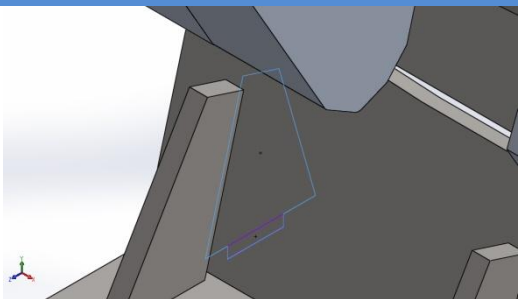
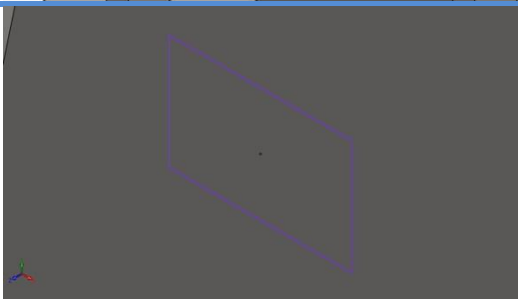
<p>Temas Seti-21</p>		<p><b>Type:</b> Bonded contact pair <b>Entites:</b> 2 face(s)</p>
<p>Temas Seti-22</p>		<p><b>Type:</b> Bonded contact pair <b>Entites:</b> 2 face(s)</p>
<p>Temas Seti-23</p>		<p><b>Type:</b> Bonded contact pair <b>Entites:</b> 2 face(s)</p>
<p>Temas Seti-24</p>		<p><b>Type:</b> Bonded contact pair <b>Entites:</b> 2 face(s)</p>
<p>Temas Seti-25</p>		<p><b>Type:</b> Bonded contact pair <b>Entites:</b> 2 face(s)</p>

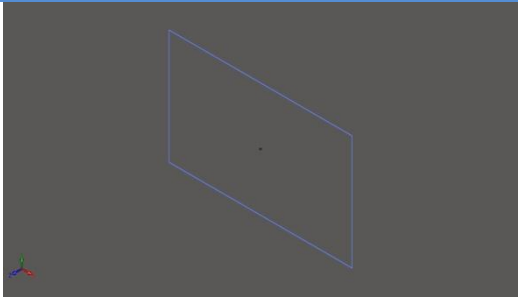
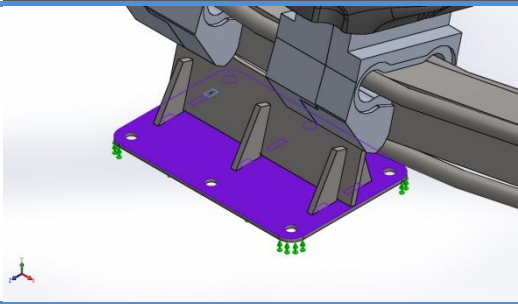
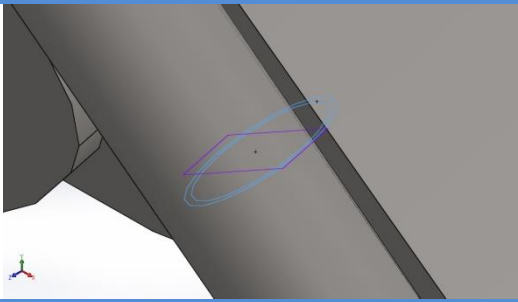
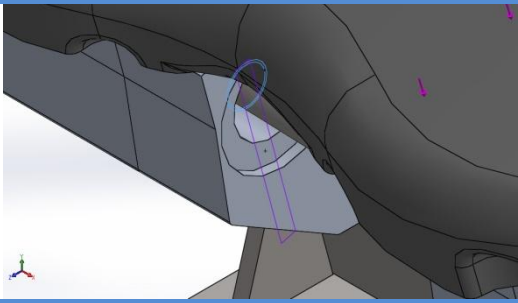
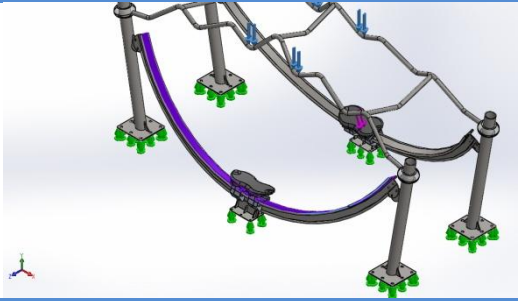

<p>Temas Seti-26</p>		<p><b>Type:</b> Bonded contact pair <b>Entites:</b> 2 face(s)</p>
<p>Temas Seti-27</p>		<p><b>Type:</b> Bonded contact pair <b>Entites:</b> 2 face(s)</p>
<p>Temas Seti-28</p>		<p><b>Type:</b> Bonded contact pair <b>Entites:</b> 2 face(s)</p>
<p>Temas Seti-29</p>		<p><b>Type:</b> Bonded contact pair <b>Entites:</b> 2 face(s)</p>
<p>Temas Seti-30</p>		<p><b>Type:</b> Bonded contact pair <b>Entites:</b> 2 face(s)</p>



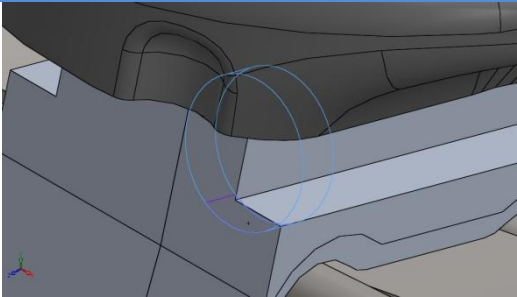
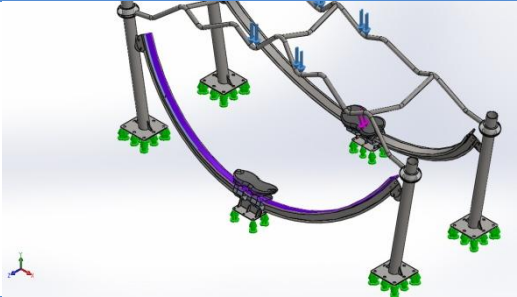
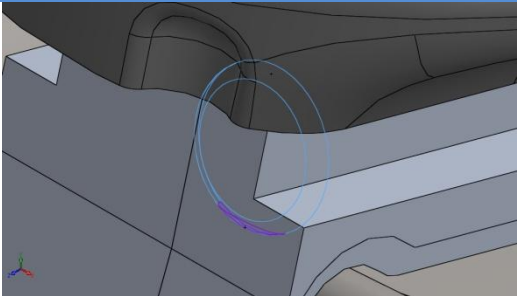
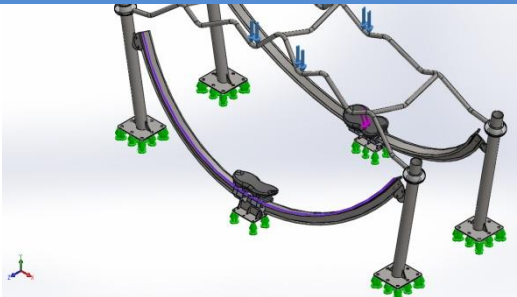
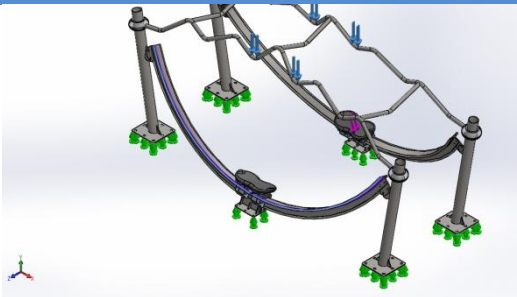

<p>Temas Seti-31</p>		<p><b>Type:</b> Bonded contact pair <b>Entites:</b> 2 face(s)</p>
<p>Temas Seti-32</p>		<p><b>Type:</b> Bonded contact pair <b>Entites:</b> 2 face(s)</p>
<p>Temas Seti-33</p>		<p><b>Type:</b> Bonded contact pair <b>Entites:</b> 2 face(s)</p>
<p>Temas Seti-34</p>		<p><b>Type:</b> Bonded contact pair <b>Entites:</b> 2 face(s)</p>
<p>Temas Seti-35</p>		<p><b>Type:</b> Bonded contact pair <b>Entites:</b> 2 face(s)</p>

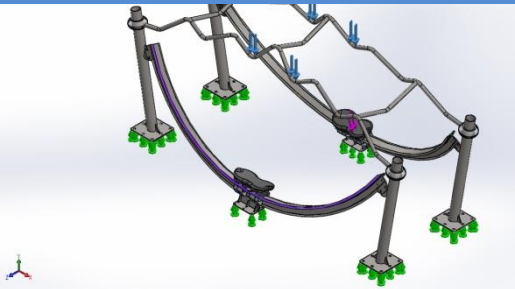
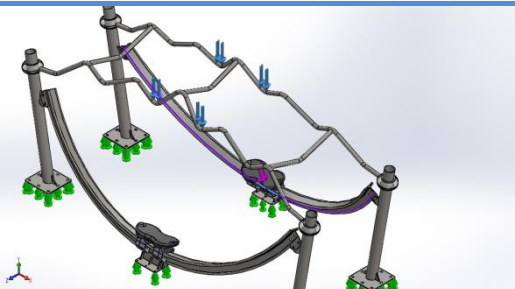
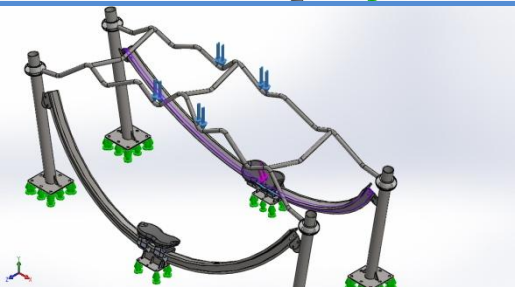
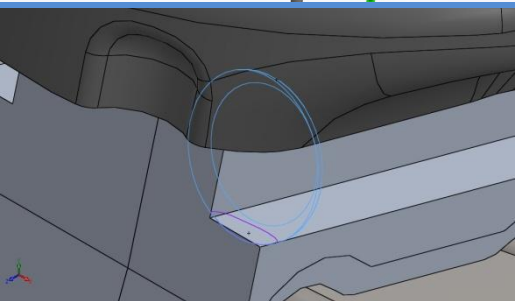
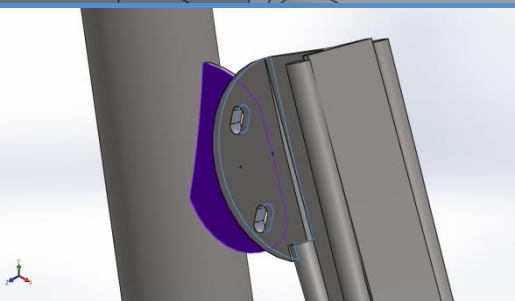
<p>Temas Seti-36</p>		<p><b>Type:</b> Bonded contact pair <b>Entites:</b> 2 face(s)</p>
<p>Temas Seti-37</p>		<p><b>Type:</b> Bonded contact pair <b>Entites:</b> 2 face(s)</p>
<p>Temas Seti-38</p>		<p><b>Type:</b> Bonded contact pair <b>Entites:</b> 2 face(s)</p>
<p>Temas Seti-39</p>		<p><b>Type:</b> Bonded contact pair <b>Entites:</b> 2 face(s)</p>
<p>Temas Seti-40</p>		<p><b>Type:</b> Bonded contact pair <b>Entites:</b> 2 face(s)</p>

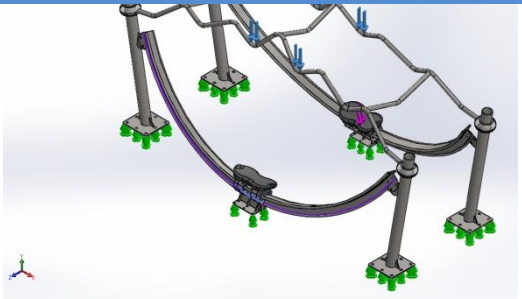
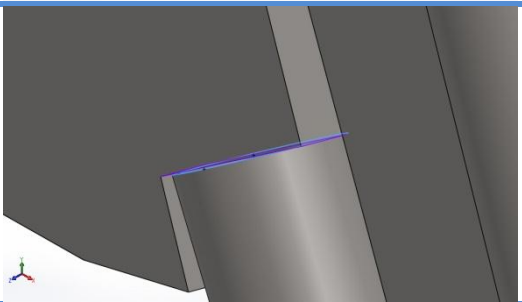
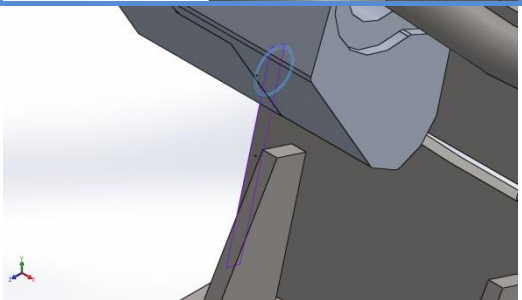
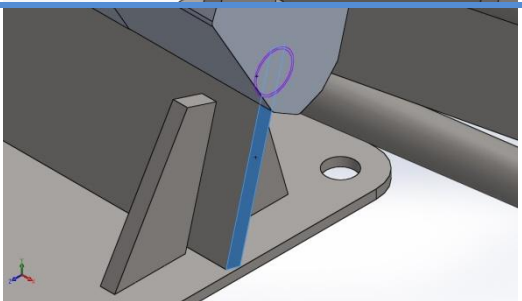
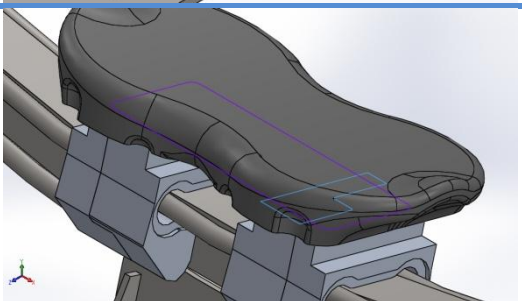
<p>Temas Seti-41</p>		<p><b>Type:</b> Bonded contact pair <b>Entites:</b> 2 face(s)</p>
<p>Temas Seti-42</p>		<p><b>Type:</b> Bonded contact pair <b>Entites:</b> 2 face(s)</p>
<p>Temas Seti-43</p>		<p><b>Type:</b> Bonded contact pair <b>Entites:</b> 2 face(s)</p>
<p>Temas Seti-44</p>		<p><b>Type:</b> Bonded contact pair <b>Entites:</b> 2 face(s)</p>
<p>Temas Seti-45</p>		<p><b>Type:</b> Bonded contact pair <b>Entites:</b> 2 face(s)</p>

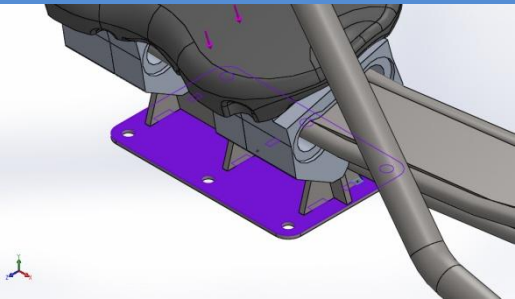
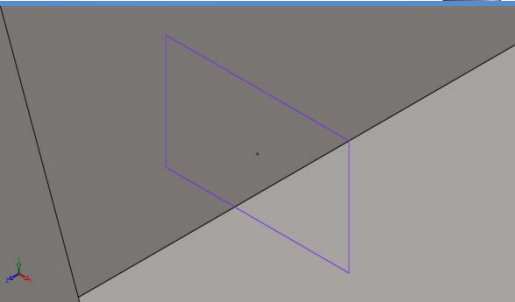
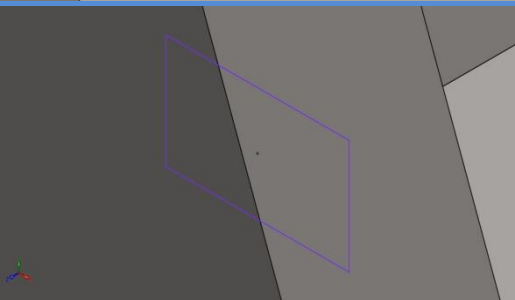
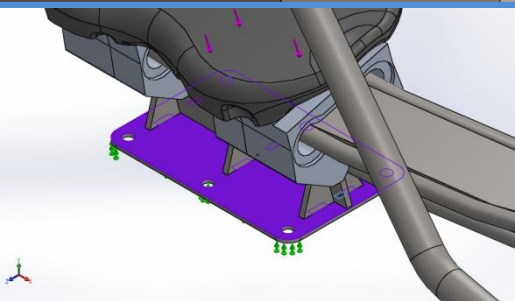
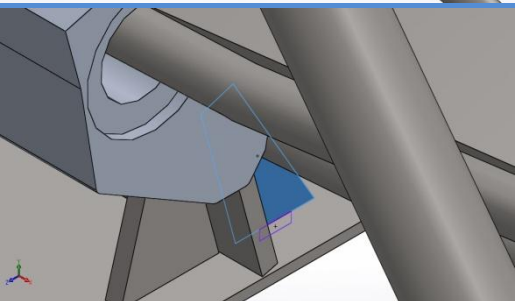
<p>Temas Seti-46</p>		<p><b>Type:</b> Bonded contact pair  <b>Entites:</b> 2 face(s)</p>
<p>Temas Seti-47</p>		<p><b>Type:</b> Bonded contact pair  <b>Entites:</b> 2 face(s)</p>
<p>Temas Seti-48</p>		<p><b>Type:</b> Bonded contact pair  <b>Entites:</b> 2 face(s)</p>
<p>Temas Seti-49</p>		<p><b>Type:</b> Bonded contact pair  <b>Entites:</b> 2 face(s)</p>
<p>Temas Seti-50</p>		<p><b>Type:</b> Bonded contact pair  <b>Entites:</b> 2 face(s)</p>

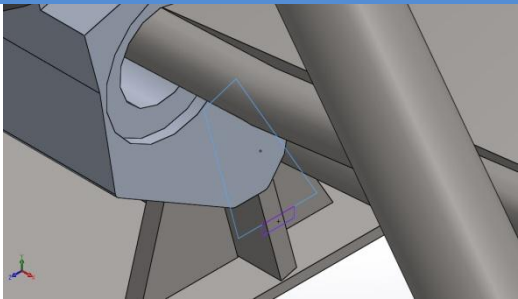
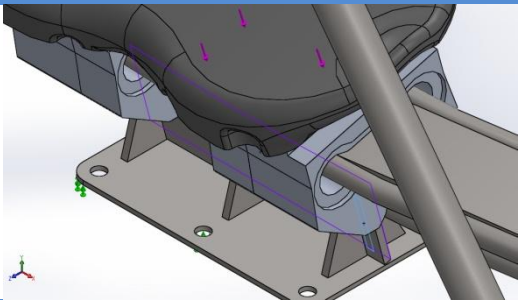
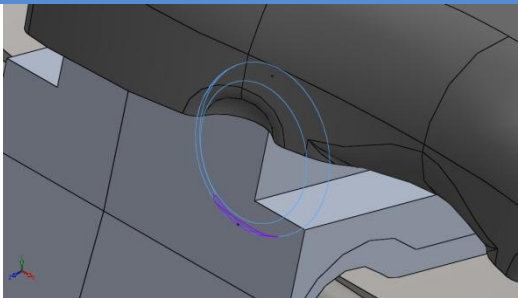
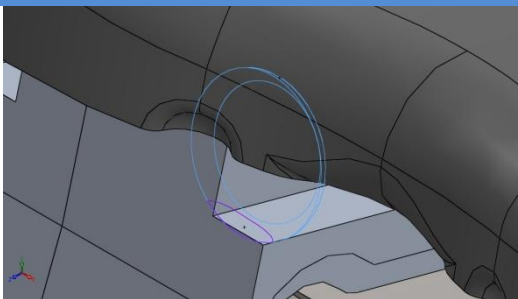
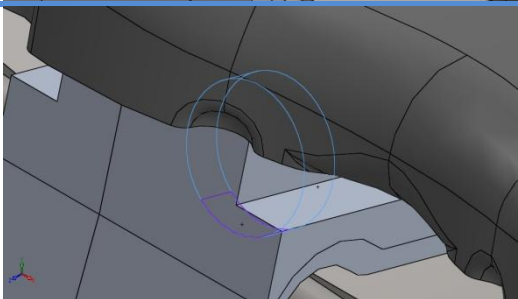
<p>Temas Seti-51</p>		<p><b>Type:</b> Bonded contact pair <b>Entites:</b> 2 face(s)</p>
<p>Temas Seti-52</p>		<p><b>Type:</b> Bonded contact pair <b>Entites:</b> 2 face(s)</p>
<p>Temas Seti-53</p>		<p><b>Type:</b> Bonded contact pair <b>Entites:</b> 2 face(s)</p>
<p>Temas Seti-54</p>		<p><b>Type:</b> Bonded contact pair <b>Entites:</b> 2 face(s)</p>
<p>Temas Seti-55</p>		<p><b>Type:</b> Bonded contact pair <b>Entites:</b> 2 face(s)</p>

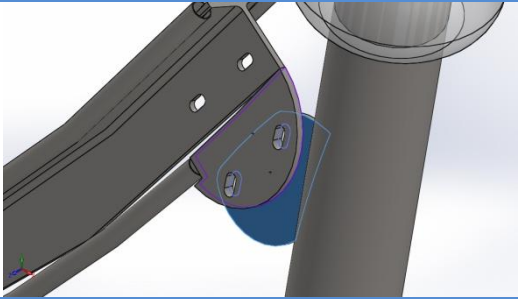
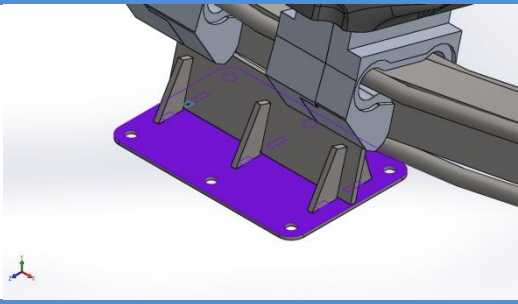
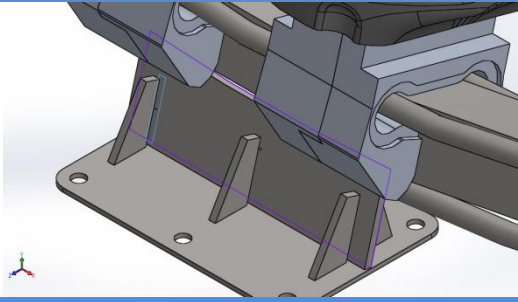
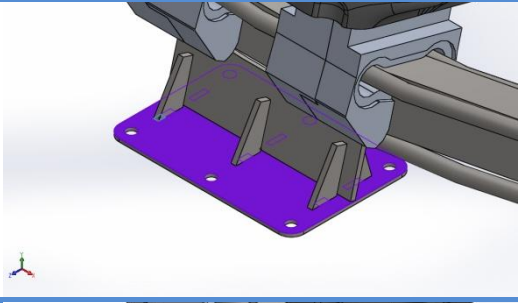
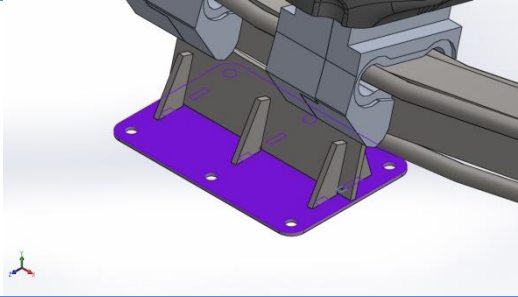
<p>Temas Seti-56</p>		<p><b>Type:</b> Bonded contact pair <b>Entites:</b> 2 face(s)</p>
<p>Temas Seti-57</p>		<p><b>Type:</b> Bonded contact pair <b>Entites:</b> 2 face(s)</p>
<p>Temas Seti-58</p>		<p><b>Type:</b> Bonded contact pair <b>Entites:</b> 2 face(s)</p>
<p>Temas Seti-59</p>		<p><b>Type:</b> Bonded contact pair <b>Entites:</b> 2 face(s)</p>
<p>Temas Seti-60</p>		<p><b>Type:</b> Bonded contact pair <b>Entites:</b> 2 face(s)</p>

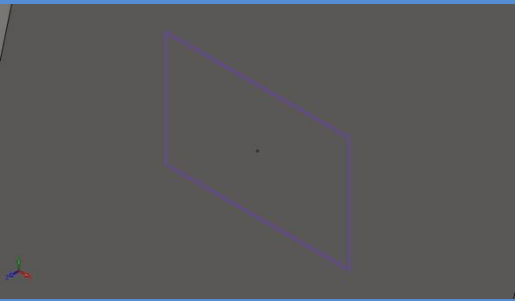
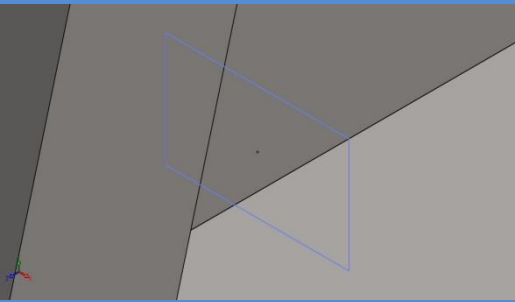
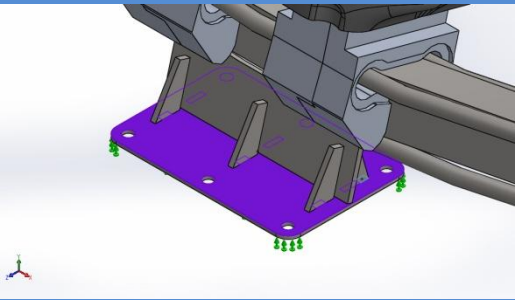
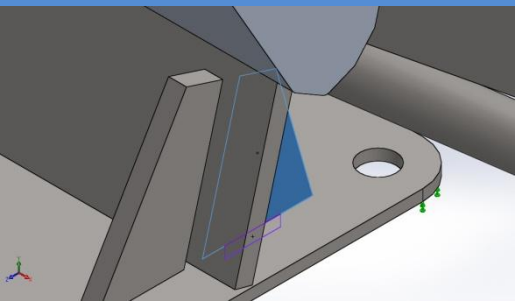
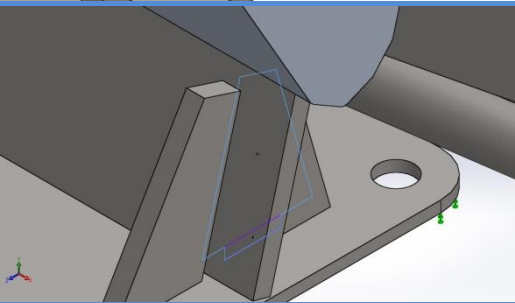

<p>Temas Seti-61</p>		<p><b>Type:</b> Bonded contact pair  <b>Entites:</b> 2 face(s)</p>
<p>Temas Seti-62</p>		<p><b>Type:</b> Bonded contact pair  <b>Entites:</b> 2 face(s)</p>
<p>Temas Seti-63</p>		<p><b>Type:</b> Bonded contact pair  <b>Entites:</b> 2 face(s)</p>
<p>Temas Seti-64</p>		<p><b>Type:</b> Bonded contact pair  <b>Entites:</b> 2 face(s)</p>
<p>Temas Seti-65</p>		<p><b>Type:</b> Bonded contact pair  <b>Entites:</b> 2 face(s)</p>

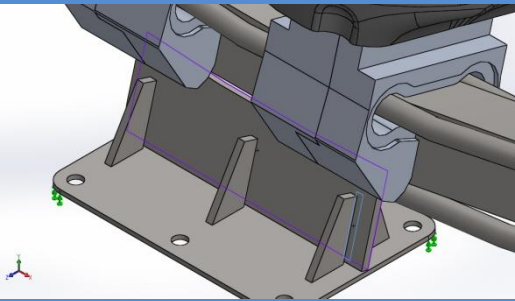
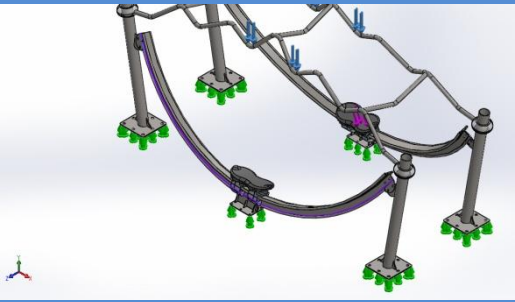
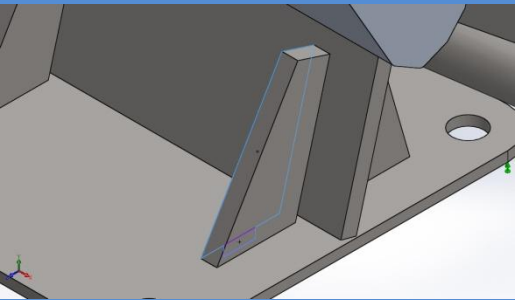
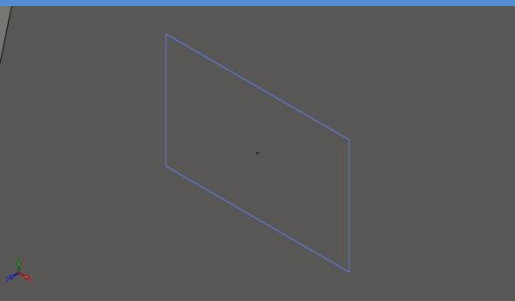
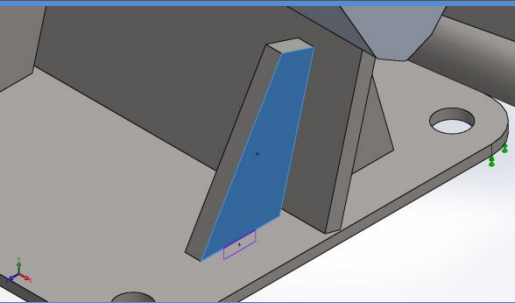
<p>Temas Seti-66</p>		<p><b>Type:</b> Bonded contact pair <b>Entites:</b> 2 face(s)</p>
<p>Temas Seti-67</p>		<p><b>Type:</b> Bonded contact pair <b>Entites:</b> 2 face(s)</p>
<p>Temas Seti-68</p>		<p><b>Type:</b> Bonded contact pair <b>Entites:</b> 2 face(s)</p>
<p>Temas Seti-69</p>		<p><b>Type:</b> Bonded contact pair <b>Entites:</b> 2 face(s)</p>
<p>Temas Seti-70</p>		<p><b>Type:</b> Bonded contact pair <b>Entites:</b> 2 face(s)</p>

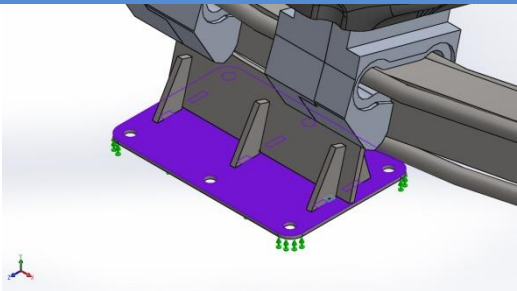
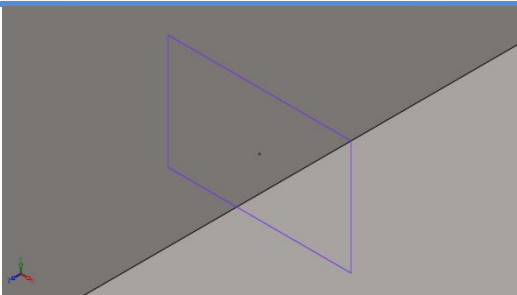
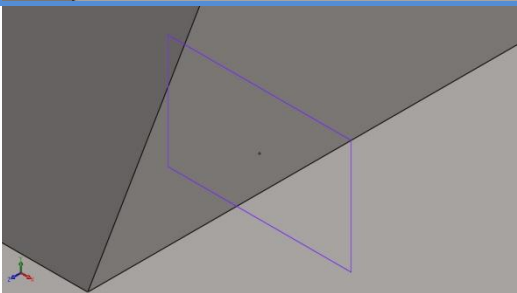
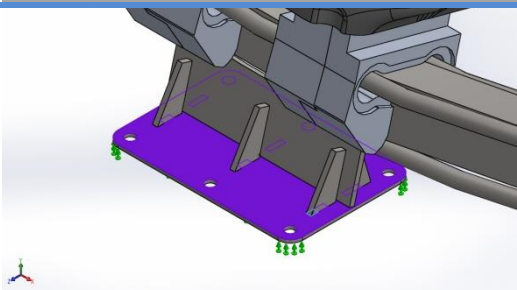
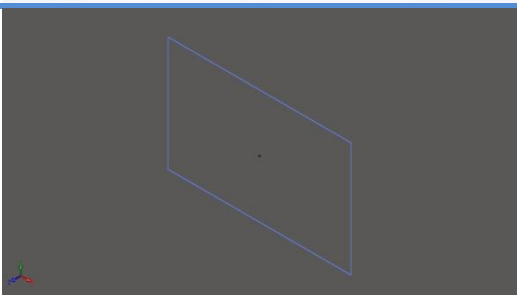

<p>Temas Seti-71</p>		<p><b>Type:</b> Bonded contact pair  <b>Entites:</b> 2 face(s)</p>
<p>Temas Seti-72</p>		<p><b>Type:</b> Bonded contact pair  <b>Entites:</b> 2 face(s)</p>
<p>Temas Seti-73</p>		<p><b>Type:</b> Bonded contact pair  <b>Entites:</b> 2 face(s)</p>
<p>Temas Seti-74</p>		<p><b>Type:</b> Bonded contact pair  <b>Entites:</b> 2 face(s)</p>
<p>Temas Seti-75</p>		<p><b>Type:</b> Bonded contact pair  <b>Entites:</b> 2 face(s)</p>

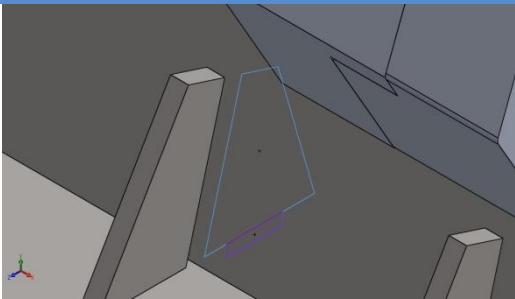
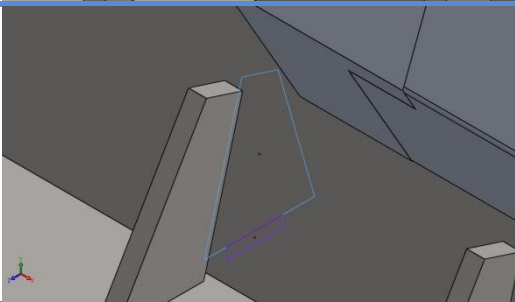
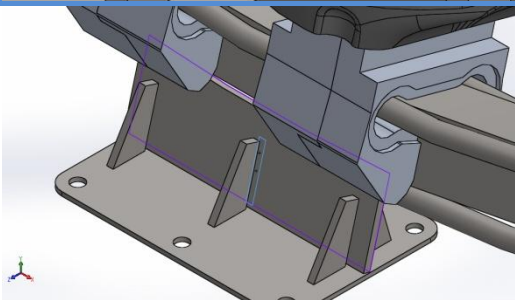
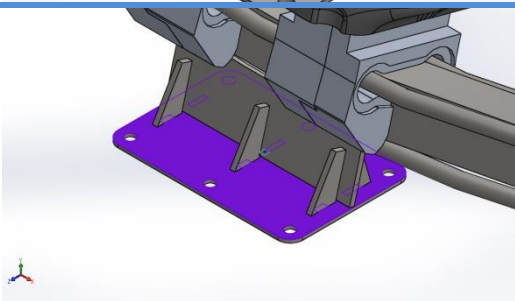
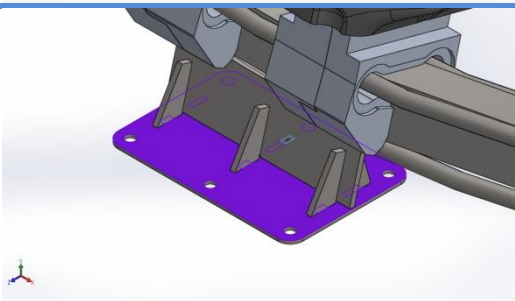

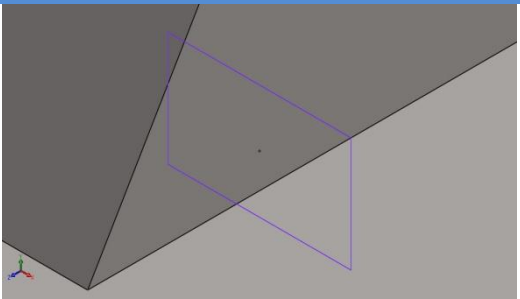
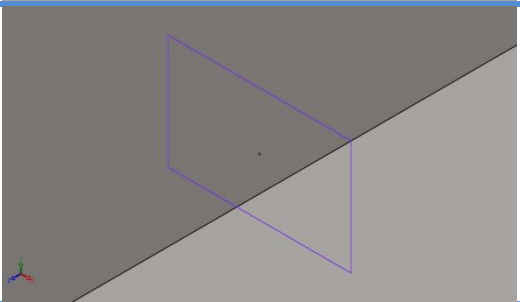
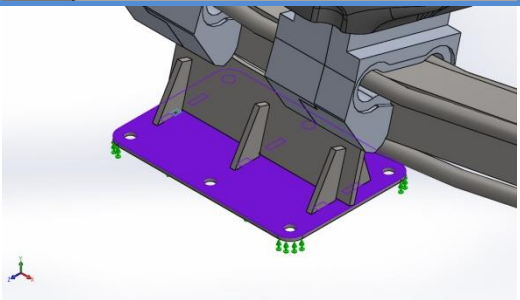
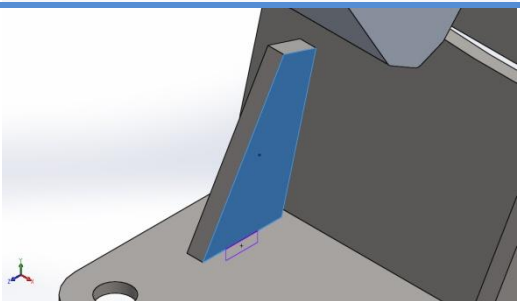
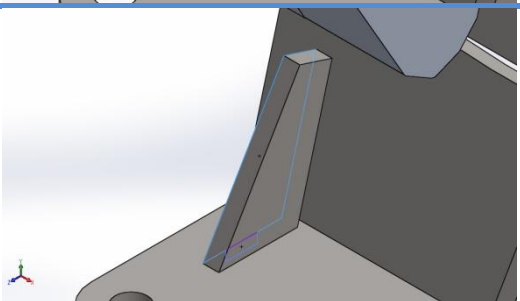
<p>Temas Seti-76</p>		<p><b>Type:</b> Bonded contact pair <b>Entites:</b> 2 face(s)</p>
<p>Temas Seti-77</p>		<p><b>Type:</b> Bonded contact pair <b>Entites:</b> 2 face(s)</p>
<p>Temas Seti-78</p>		<p><b>Type:</b> Bonded contact pair <b>Entites:</b> 2 face(s)</p>
<p>Temas Seti-79</p>		<p><b>Type:</b> Bonded contact pair <b>Entites:</b> 2 face(s)</p>
<p>Temas Seti-80</p>		<p><b>Type:</b> Bonded contact pair <b>Entites:</b> 2 face(s)</p>

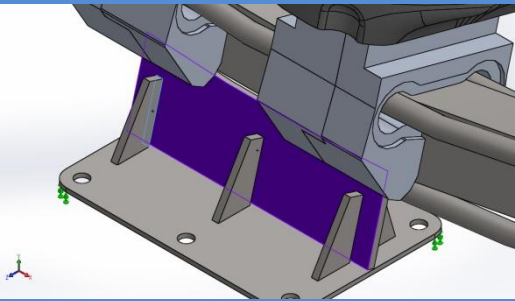
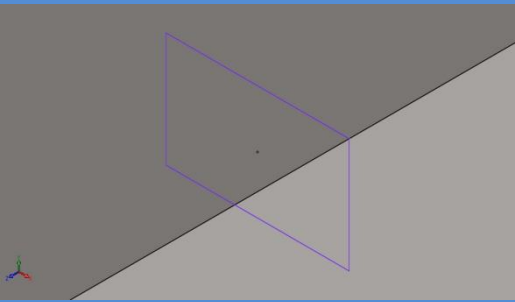
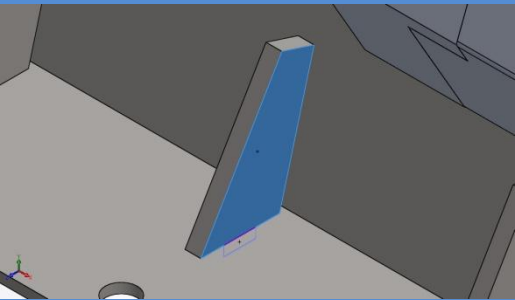
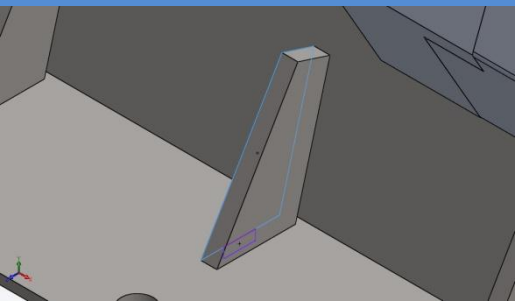
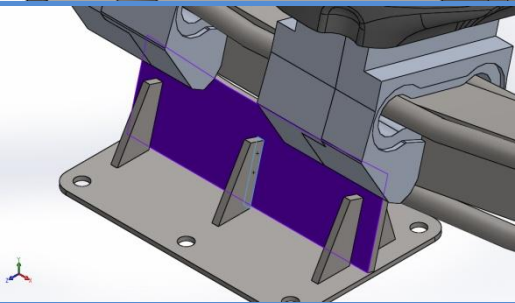
<p>Temas Seti-81</p>		<p><b>Type:</b> Bonded contact pair <b>Entites:</b> 2 face(s)</p>
<p>Temas Seti-82</p>		<p><b>Type:</b> Bonded contact pair <b>Entites:</b> 2 face(s)</p>
<p>Temas Seti-83</p>		<p><b>Type:</b> Bonded contact pair <b>Entites:</b> 2 face(s)</p>
<p>Temas Seti-84</p>		<p><b>Type:</b> Bonded contact pair <b>Entites:</b> 2 face(s)</p>
<p>Temas Seti-85</p>		<p><b>Type:</b> Bonded contact pair <b>Entites:</b> 2 face(s)</p>

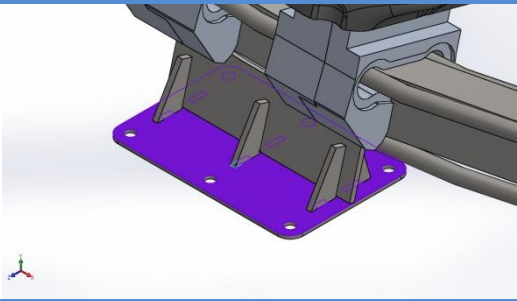
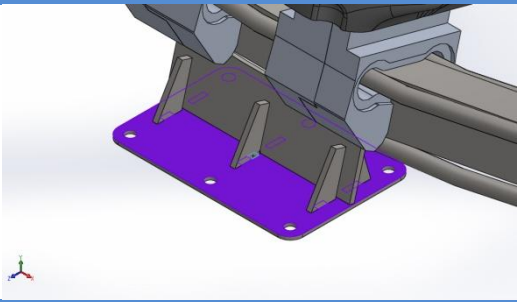
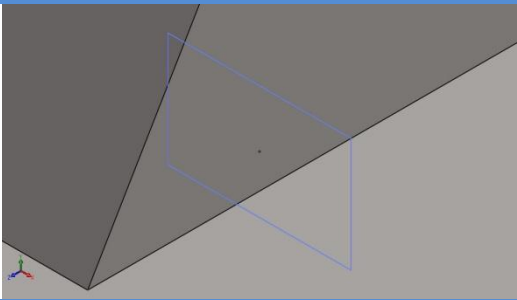
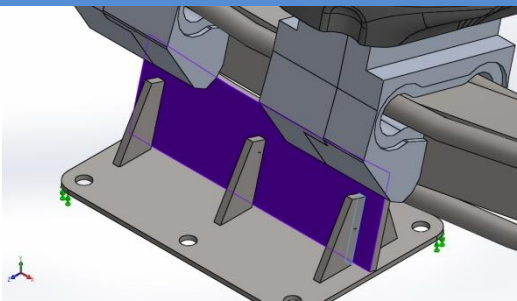
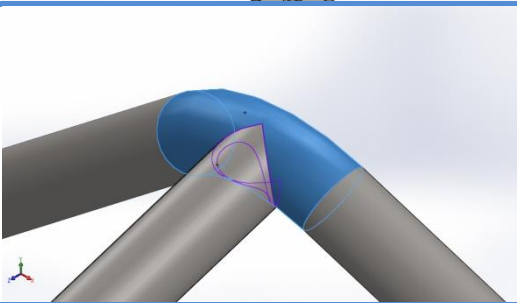
<p>Temas Seti-86</p>		<p><b>Type:</b> Bonded contact pair  <b>Entites:</b> 2 face(s)</p>
<p>Temas Seti-87</p>		<p><b>Type:</b> Bonded contact pair  <b>Entites:</b> 2 face(s)</p>
<p>Temas Seti-88</p>		<p><b>Type:</b> Bonded contact pair  <b>Entites:</b> 2 face(s)</p>
<p>Temas Seti-89</p>		<p><b>Type:</b> Bonded contact pair  <b>Entites:</b> 2 face(s)</p>
<p>Temas Seti-90</p>		<p><b>Type:</b> Bonded contact pair  <b>Entites:</b> 2 face(s)</p>

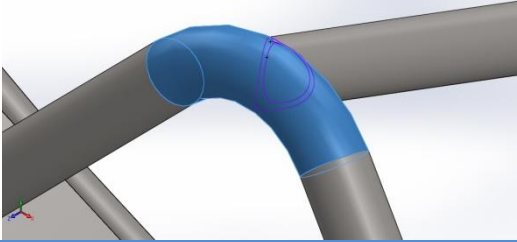
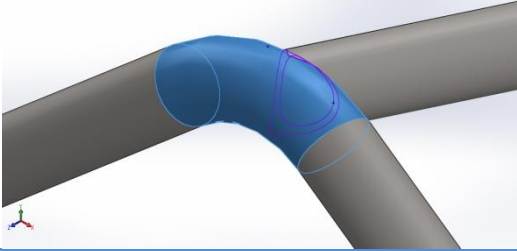
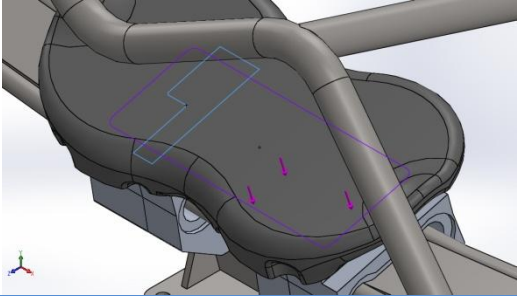
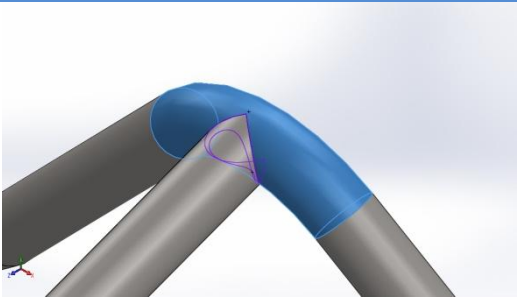
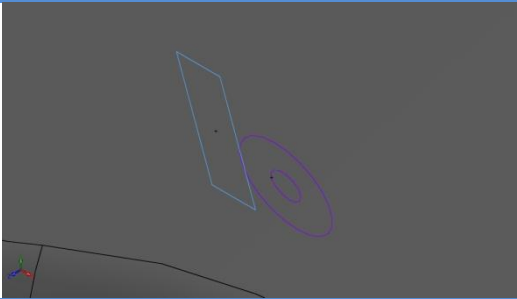
<p>Temas Seti-91</p>		<p><b>Type:</b> Bonded contact pair <b>Entites:</b> 2 face(s)</p>
<p>Temas Seti-92</p>		<p><b>Type:</b> Bonded contact pair <b>Entites:</b> 2 face(s)</p>
<p>Temas Seti-93</p>		<p><b>Type:</b> Bonded contact pair <b>Entites:</b> 2 face(s)</p>
<p>Temas Seti-94</p>		<p><b>Type:</b> Bonded contact pair <b>Entites:</b> 2 face(s)</p>
<p>Temas Seti-95</p>		<p><b>Type:</b> Bonded contact pair <b>Entites:</b> 2 face(s)</p>

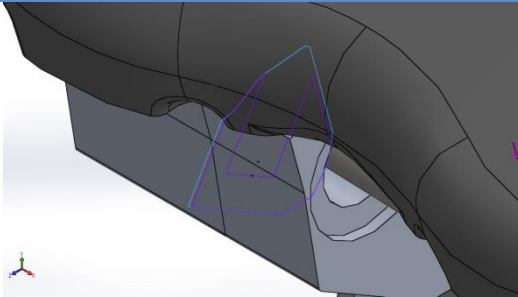
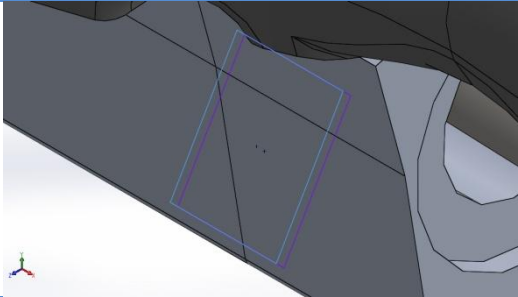
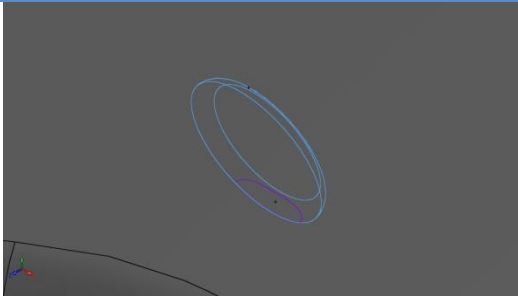
<p>Temas Seti-96</p>		<p><b>Type:</b> Bonded contact pair <b>Entites:</b> 2 face(s)</p>
<p>Temas Seti-97</p>		<p><b>Type:</b> Bonded contact pair <b>Entites:</b> 2 face(s)</p>
<p>Temas Seti-98</p>		<p><b>Type:</b> Bonded contact pair <b>Entites:</b> 2 face(s)</p>
<p>Temas Seti-99</p>		<p><b>Type:</b> Bonded contact pair <b>Entites:</b> 2 face(s)</p>
<p>Temas Seti-100</p>		<p><b>Type:</b> Bonded contact pair <b>Entites:</b> 2 face(s)</p>

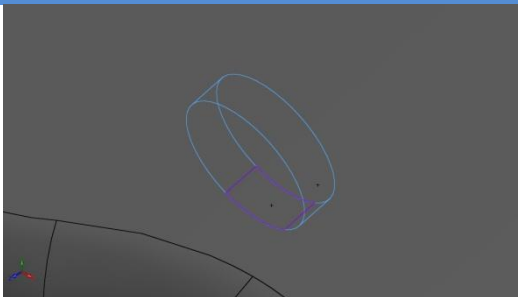
<p>Temas Seti-101</p>		<p><b>Type:</b> Bonded contact pair <b>Entites:</b> 2 face(s)</p>
<p>Temas Seti-102</p>		<p><b>Type:</b> Bonded contact pair <b>Entites:</b> 2 face(s)</p>
<p>Temas Seti-103</p>		<p><b>Type:</b> Bonded contact pair <b>Entites:</b> 2 face(s)</p>
<p>Temas Seti-104</p>		<p><b>Type:</b> Bonded contact pair <b>Entites:</b> 2 face(s)</p>
<p>Temas Seti-105</p>		<p><b>Type:</b> Bonded contact pair <b>Entites:</b> 2 face(s)</p>

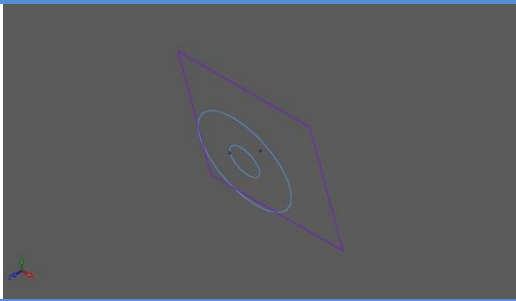
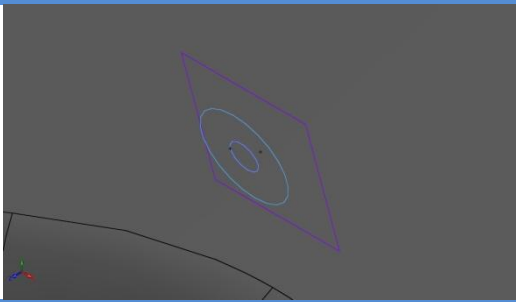
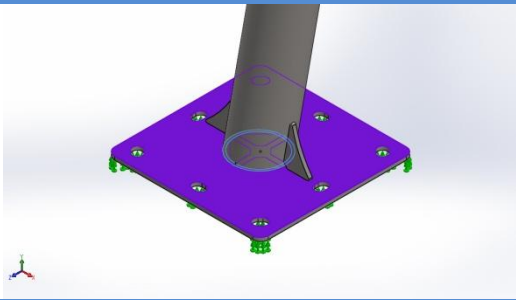
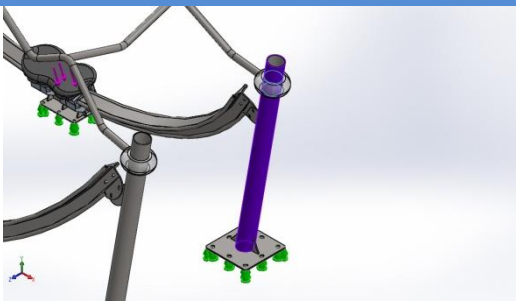
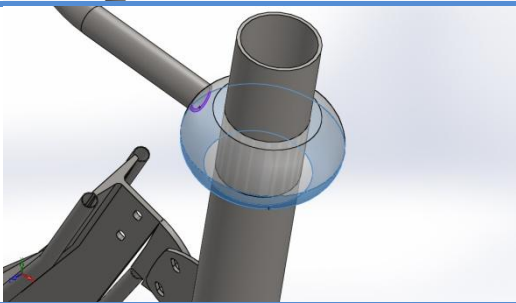

<p>Temas Seti-106</p>		<p><b>Type:</b> Bonded contact pair <b>Entites:</b> 2 face(s)</p>
<p>Temas Seti-107</p>		<p><b>Type:</b> Bonded contact pair <b>Entites:</b> 2 face(s)</p>
<p>Temas Seti-108</p>		<p><b>Type:</b> Bonded contact pair <b>Entites:</b> 2 face(s)</p>
<p>Temas Seti-109</p>		<p><b>Type:</b> Bonded contact pair <b>Entites:</b> 2 face(s)</p>
<p>Temas Seti-110</p>		<p><b>Type:</b> Bonded contact pair <b>Entites:</b> 2 face(s)</p>

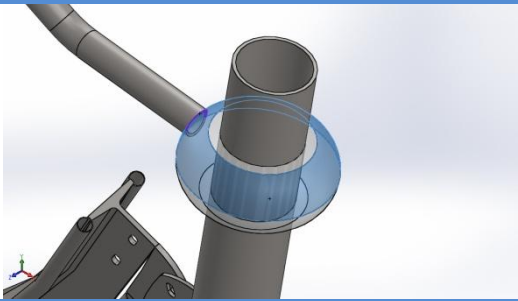
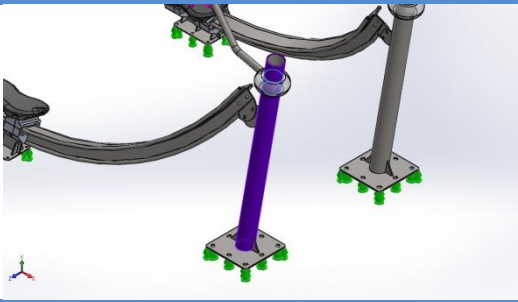
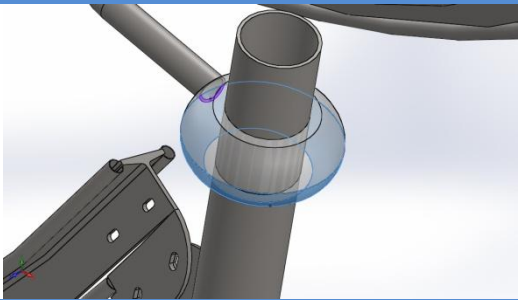
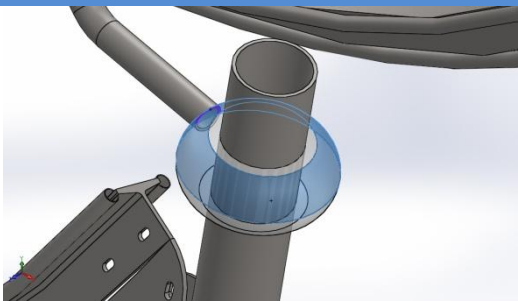
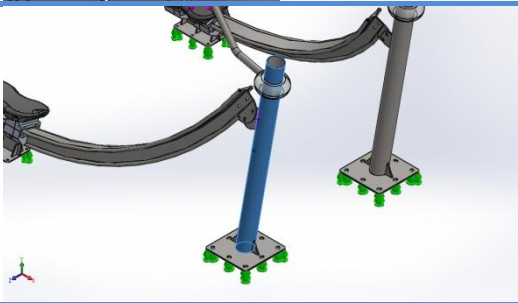

<p>Temas Seti-111</p>		<p><b>Type:</b> Bonded contact pair <b>Entites:</b> 2 face(s)</p>
<p>Temas Seti-112</p>		<p><b>Type:</b> Bonded contact pair <b>Entites:</b> 2 face(s)</p>
<p>Temas Seti-113</p>		<p><b>Type:</b> Bonded contact pair <b>Entites:</b> 2 face(s)</p>
<p>Temas Seti-114</p>		<p><b>Type:</b> Bonded contact pair <b>Entites:</b> 2 face(s)</p>
<p>Temas Seti-115</p>		<p><b>Type:</b> Bonded contact pair <b>Entites:</b> 2 face(s)</p>

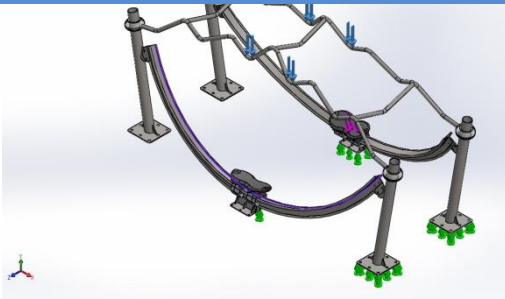
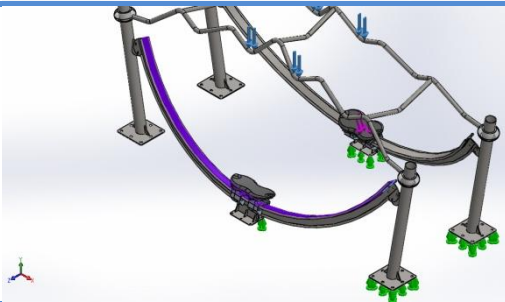
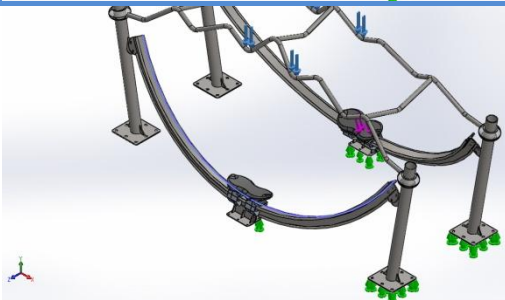
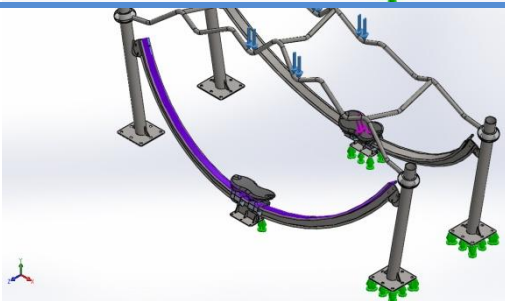
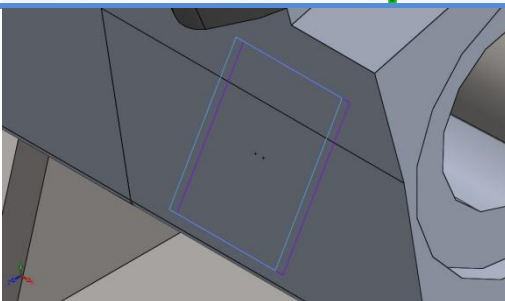
<p>Temas Seti-116</p>		<p><b>Type:</b> Bonded contact pair <b>Entites:</b> 2 face(s)</p>
<p>Temas Seti-117</p>		<p><b>Type:</b> Bonded contact pair <b>Entites:</b> 2 face(s)</p>
<p>Temas Seti-118</p>		<p><b>Type:</b> Bonded contact pair <b>Entites:</b> 2 face(s)</p>
<p>Temas Seti-119</p>		<p><b>Type:</b> Bonded contact pair <b>Entites:</b> 2 face(s)</p>
<p>Temas Seti-120</p>		<p><b>Type:</b> Bonded contact pair <b>Entites:</b> 2 face(s)</p>

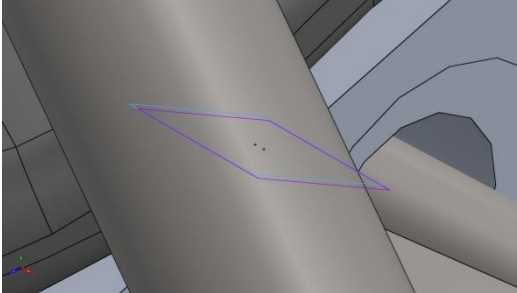
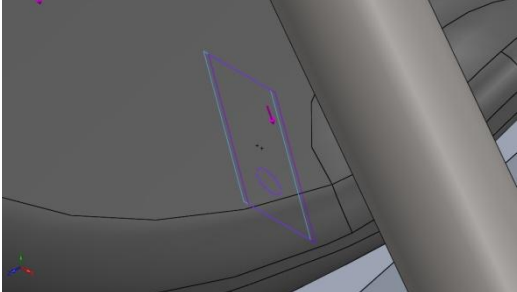
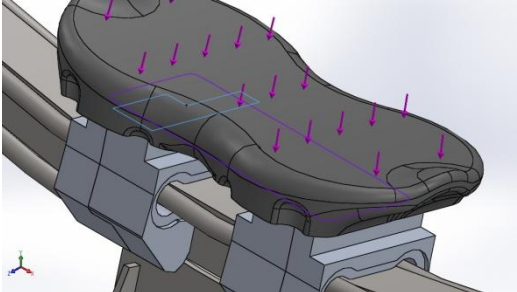
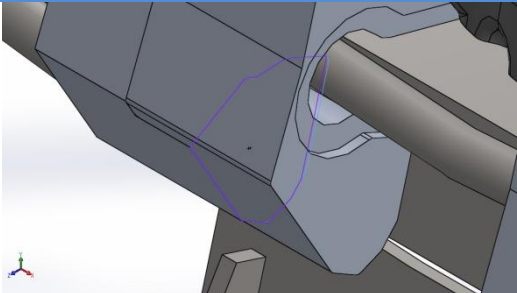
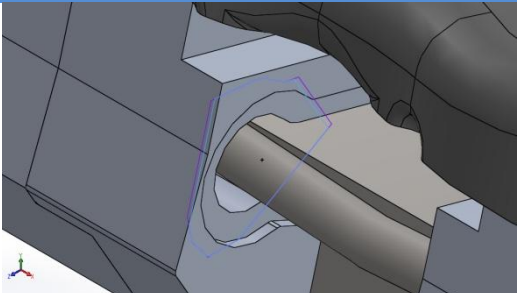
<p>Temas Seti-121</p>		<p><b>Type:</b> Bonded contact pair <b>Entites:</b> 2 face(s)</p>
<p>Temas Seti-122</p>		<p><b>Type:</b> Bonded contact pair <b>Entites:</b> 2 face(s)</p>
<p>Temas Seti-123</p>		<p><b>Type:</b> Bonded contact pair <b>Entites:</b> 2 face(s)</p>
<p>Temas Seti-124</p>		<p><b>Type:</b> Bonded contact pair <b>Entites:</b> 2 face(s)</p>
<p>Temas Seti-125</p>		<p><b>Type:</b> Bonded contact pair <b>Entites:</b> 2 face(s)</p>

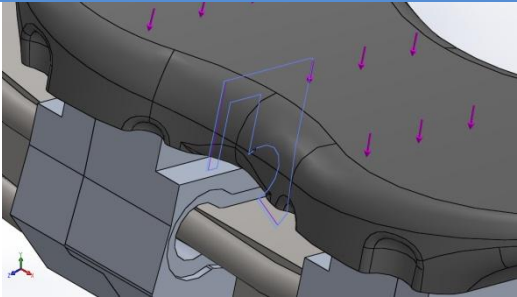
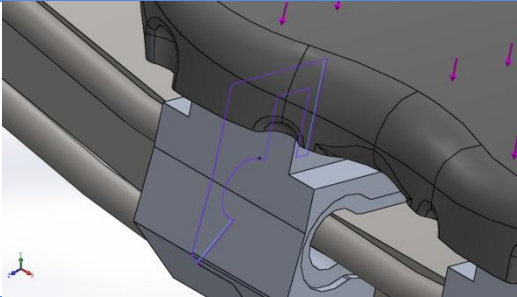
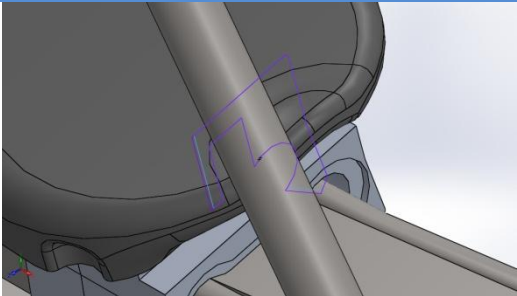
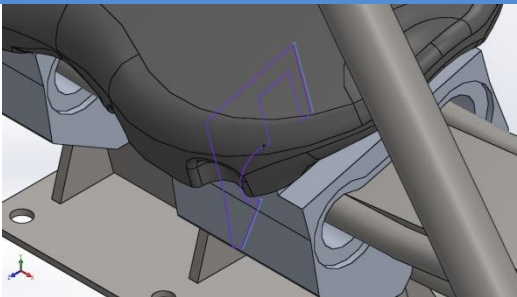
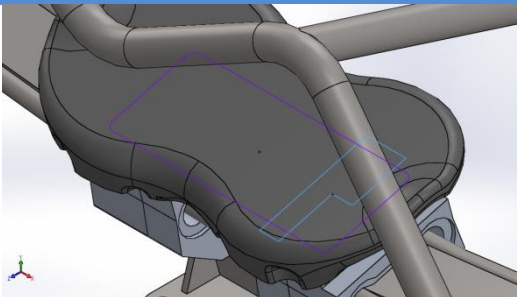
<p>Temas Seti-126</p>		<p><b>Type:</b> Bonded contact pair <b>Entites:</b> 2 face(s)</p>
<p>Temas Seti-127</p>		<p><b>Type:</b> Bonded contact pair <b>Entites:</b> 2 face(s)</p>
<p>Temas Seti-128</p>		<p><b>Type:</b> Bonded contact pair <b>Entites:</b> 2 face(s)</p>
<p>Temas Seti-129</p>		<p><b>Type:</b> Bonded contact pair <b>Entites:</b> 2 face(s)</p>
<p>Temas Seti-130</p>		<p><b>Type:</b> Bonded contact pair <b>Entites:</b> 2 face(s)</p>

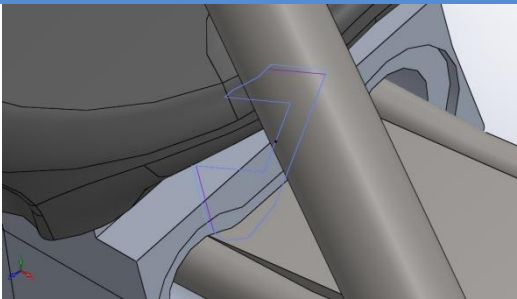
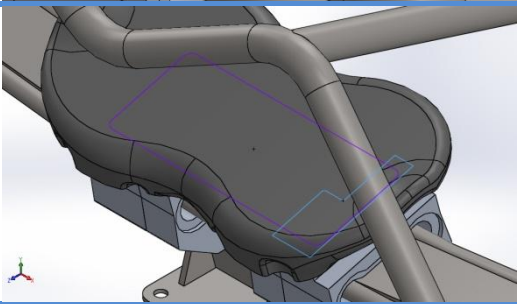
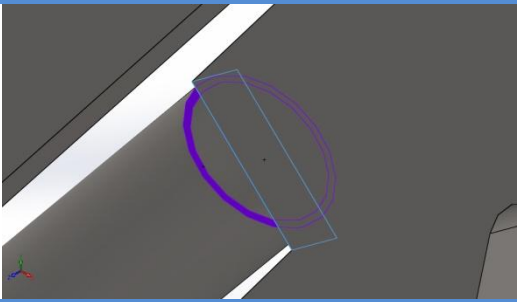
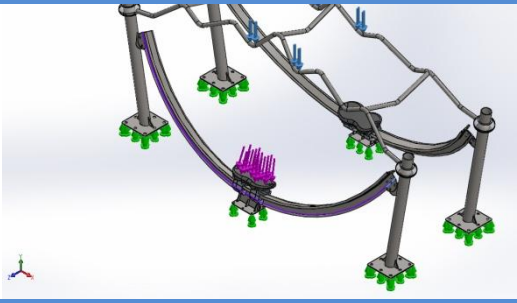
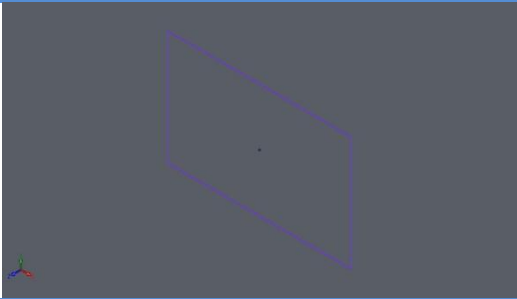
<p>Temas Seti-131</p>		<p><b>Type:</b> Bonded contact pair <b>Entites:</b> 2 face(s)</p>
<p>Temas Seti-132</p>		<p><b>Type:</b> Bonded contact pair <b>Entites:</b> 2 face(s)</p>
<p>Temas Seti-133</p>		<p><b>Type:</b> Bonded contact pair <b>Entites:</b> 2 face(s)</p>
<p>Temas Seti-134</p>		<p><b>Type:</b> Bonded contact pair <b>Entites:</b> 2 face(s)</p>
<p>Temas Seti-135</p>		<p><b>Type:</b> Bonded contact pair <b>Entites:</b> 2 face(s)</p>

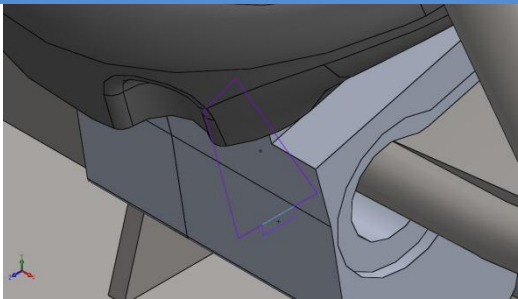
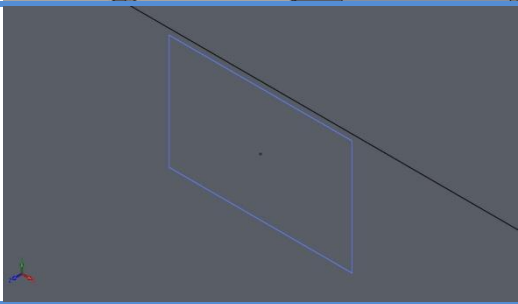
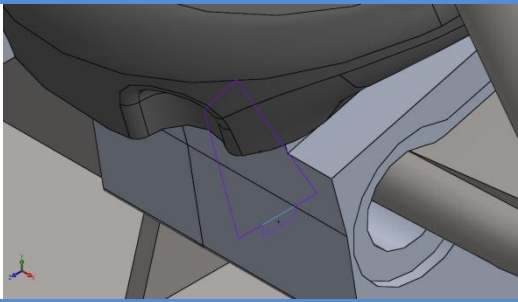
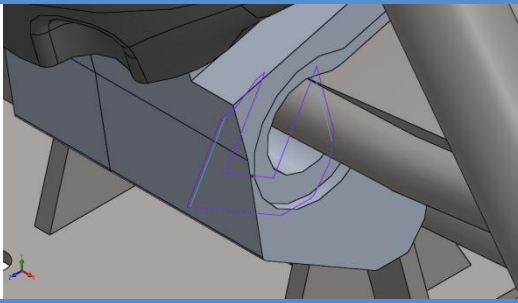
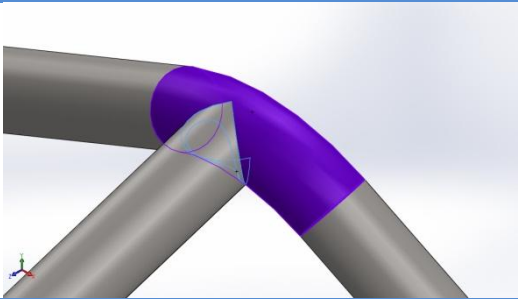
<p>Temas Seti-136</p>		<p><b>Type:</b> Bonded contact pair  <b>Entites:</b> 2 face(s)</p>
<p>Temas Seti-137</p>		<p><b>Type:</b> Bonded contact pair  <b>Entites:</b> 2 face(s)</p>
<p>Temas Seti-138</p>		<p><b>Type:</b> Bonded contact pair  <b>Entites:</b> 2 face(s)</p>
<p>Temas Seti-139</p>		<p><b>Type:</b> Bonded contact pair  <b>Entites:</b> 2 face(s)</p>
<p>Temas Seti-140</p>		<p><b>Type:</b> Bonded contact pair  <b>Entites:</b> 2 face(s)</p>

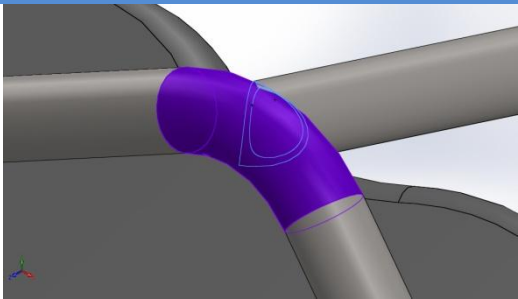
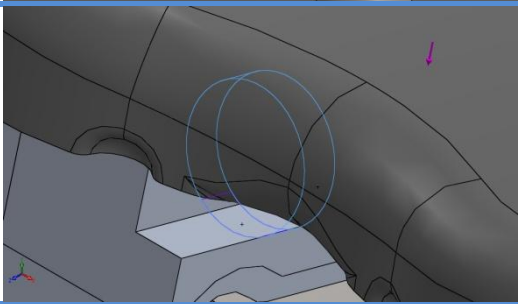
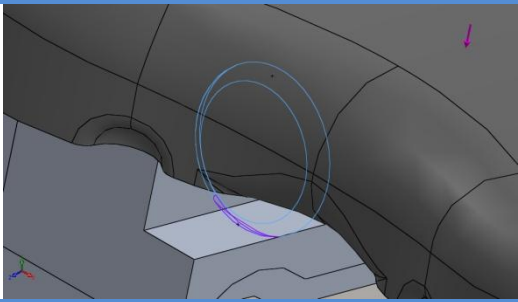
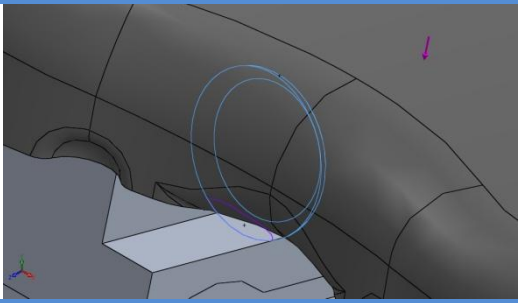
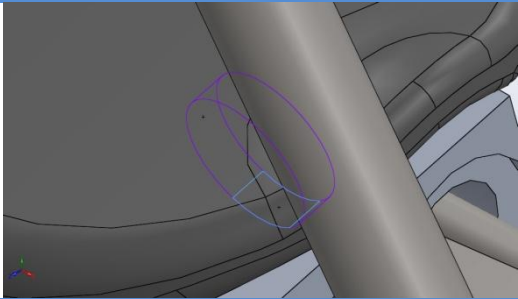

<p>Temas Seti-141</p>		<p><b>Type:</b> Bonded contact pair <b>Entites:</b> 2 face(s)</p>
<p>Temas Seti-142</p>		<p><b>Type:</b> Bonded contact pair <b>Entites:</b> 2 face(s)</p>
<p>Temas Seti-143</p>		<p><b>Type:</b> Bonded contact pair <b>Entites:</b> 2 face(s)</p>
<p>Temas Seti-144</p>		<p><b>Type:</b> Bonded contact pair <b>Entites:</b> 2 face(s)</p>
<p>Temas Seti-145</p>		<p><b>Type:</b> Bonded contact pair <b>Entites:</b> 2 face(s)</p>

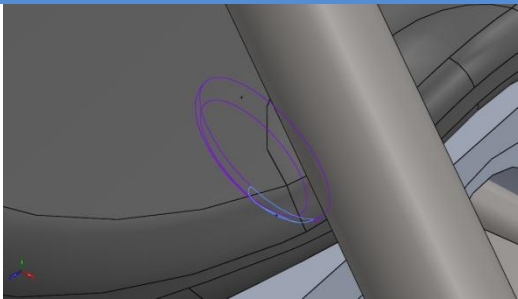
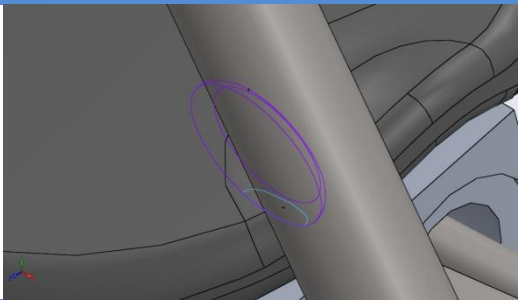
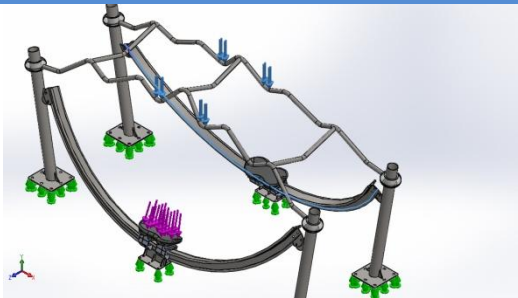
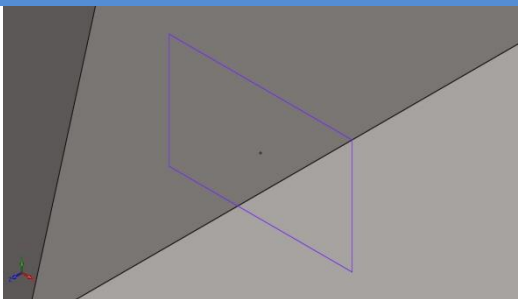
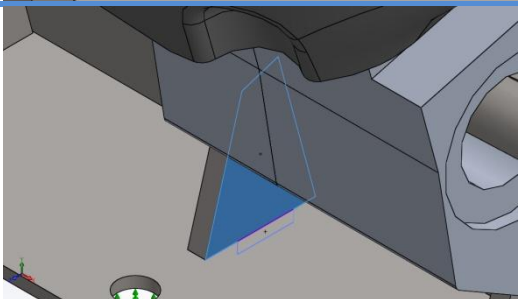

<p>Temas Seti-146</p>		<p><b>Type:</b> Bonded contact pair <b>Entites:</b> 2 face(s)</p>
<p>Temas Seti-147</p>		<p><b>Type:</b> Bonded contact pair <b>Entites:</b> 2 face(s)</p>
<p>Temas Seti-148</p>		<p><b>Type:</b> Bonded contact pair <b>Entites:</b> 2 face(s)</p>
<p>Temas Seti-149</p>		<p><b>Type:</b> Bonded contact pair <b>Entites:</b> 2 face(s)</p>
<p>Temas Seti-150</p>		<p><b>Type:</b> Bonded contact pair <b>Entites:</b> 2 face(s)</p>

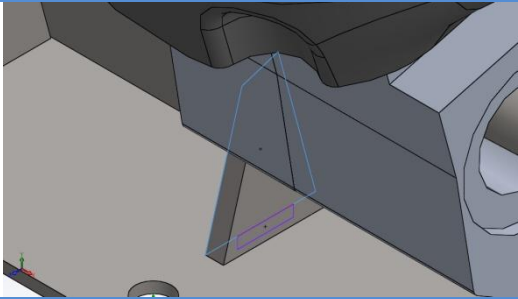
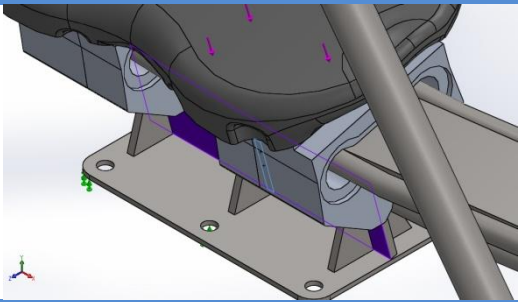
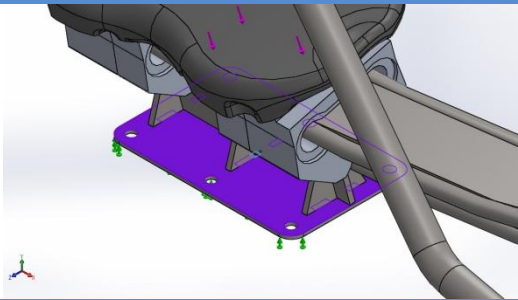
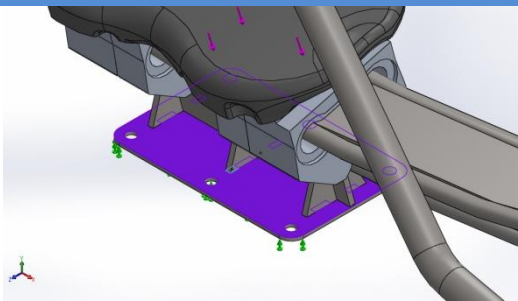
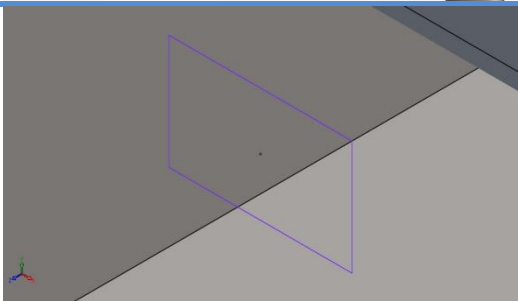
<p>Temas Seti-151</p>		<p><b>Type:</b> Bonded contact pair <b>Entites:</b> 2 face(s)</p>
<p>Temas Seti-152</p>		<p><b>Type:</b> Bonded contact pair <b>Entites:</b> 2 face(s)</p>
<p>Temas Seti-153</p>		<p><b>Type:</b> Bonded contact pair <b>Entites:</b> 2 face(s)</p>
<p>Temas Seti-154</p>		<p><b>Type:</b> Bonded contact pair <b>Entites:</b> 2 face(s)</p>
<p>Temas Seti-155</p>		<p><b>Type:</b> Bonded contact pair <b>Entites:</b> 2 face(s)</p>

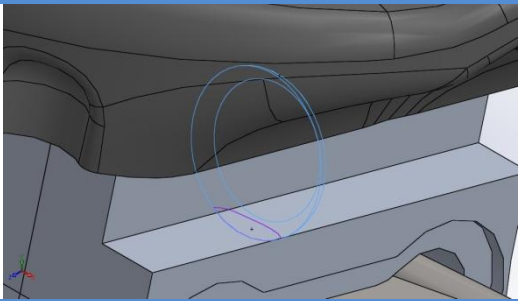
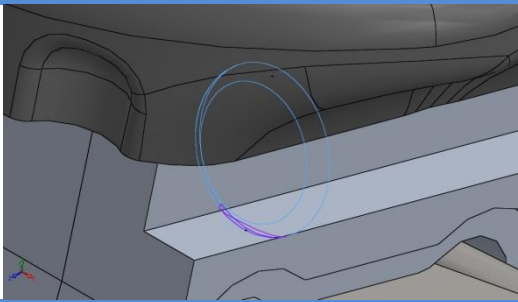
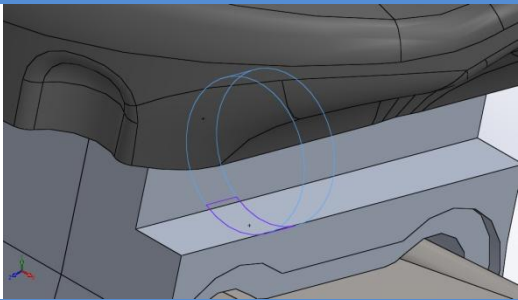
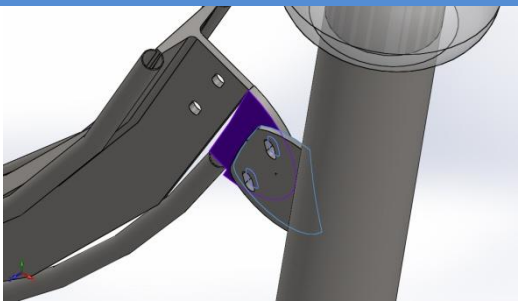
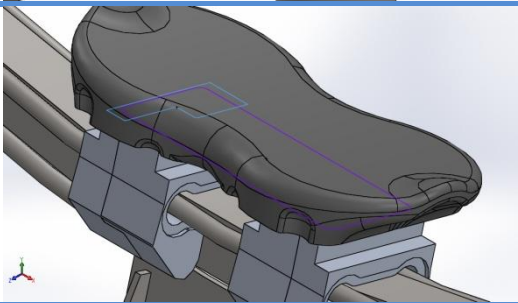
<p>Temas Seti-156</p>		<p><b>Type:</b> Bonded contact pair <b>Entites:</b> 2 face(s)</p>
<p>Temas Seti-157</p>		<p><b>Type:</b> Bonded contact pair <b>Entites:</b> 2 face(s)</p>
<p>Temas Seti-158</p>		<p><b>Type:</b> Bonded contact pair <b>Entites:</b> 2 face(s)</p>
<p>Temas Seti-159</p>		<p><b>Type:</b> Bonded contact pair <b>Entites:</b> 2 face(s)</p>
<p>Temas Seti-160</p>		<p><b>Type:</b> Bonded contact pair <b>Entites:</b> 2 face(s)</p>

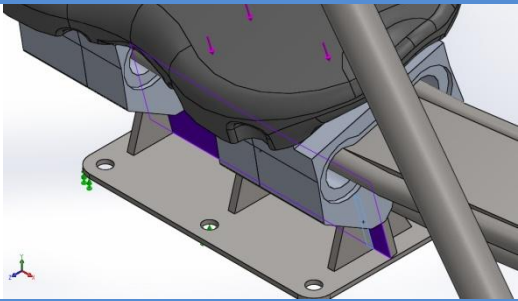
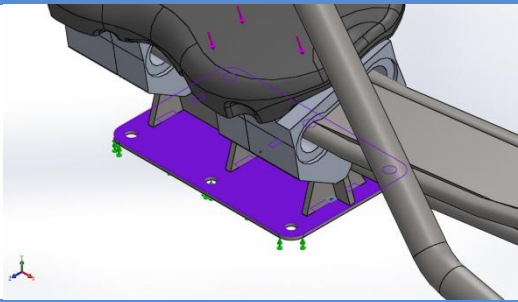
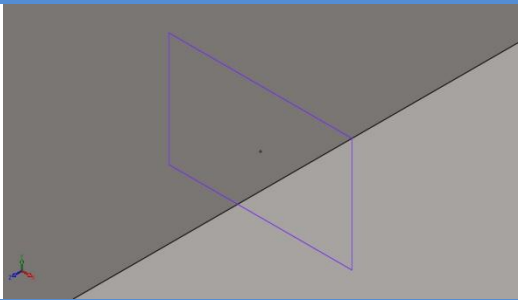
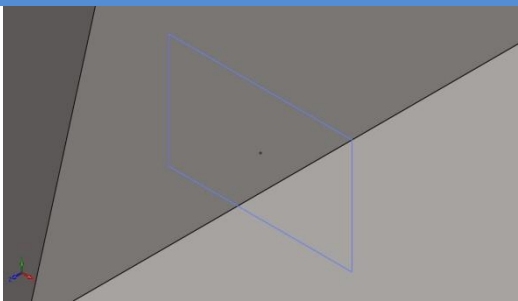
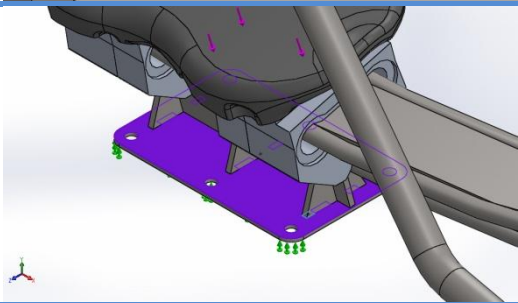
<p>Temas Seti-161</p>		<p><b>Type:</b> Bonded contact pair <b>Entites:</b> 2 face(s)</p>
<p>Temas Seti-162</p>		<p><b>Type:</b> Bonded contact pair <b>Entites:</b> 2 face(s)</p>
<p>Temas Seti-163</p>		<p><b>Type:</b> Bonded contact pair <b>Entites:</b> 2 face(s)</p>
<p>Temas Seti-164</p>		<p><b>Type:</b> Bonded contact pair <b>Entites:</b> 2 face(s)</p>
<p>Temas Seti-165</p>		<p><b>Type:</b> Bonded contact pair <b>Entites:</b> 2 face(s)</p>

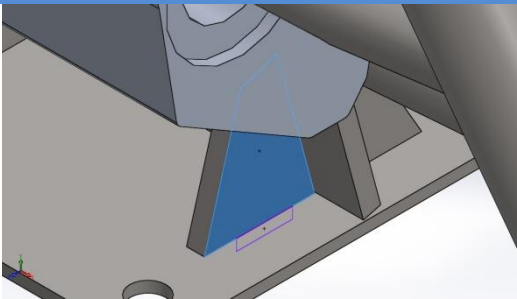
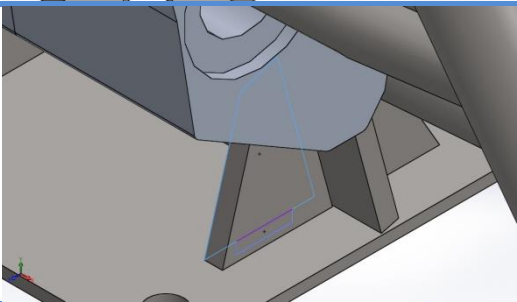
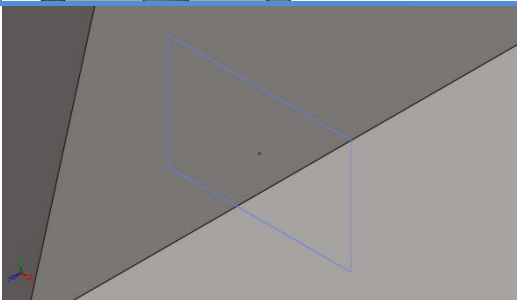
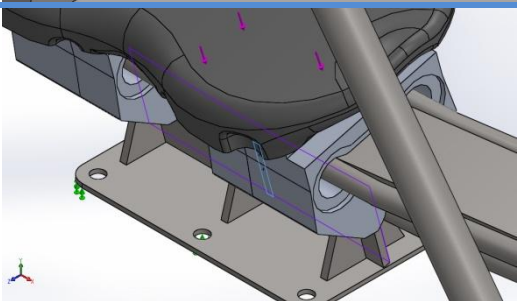
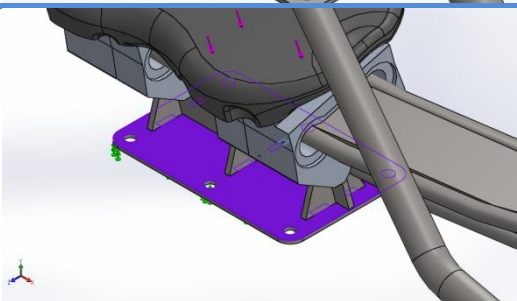
<p>Temas Seti-166</p>		<p><b>Type:</b> Bonded contact pair <b>Entites:</b> 2 face(s)</p>
<p>Temas Seti-167</p>		<p><b>Type:</b> Bonded contact pair <b>Entites:</b> 2 face(s)</p>
<p>Temas Seti-168</p>		<p><b>Type:</b> Bonded contact pair <b>Entites:</b> 2 face(s)</p>
<p>Temas Seti-169</p>		<p><b>Type:</b> Bonded contact pair <b>Entites:</b> 2 face(s)</p>
<p>Temas Seti-170</p>		<p><b>Type:</b> Bonded contact pair <b>Entites:</b> 2 face(s)</p>

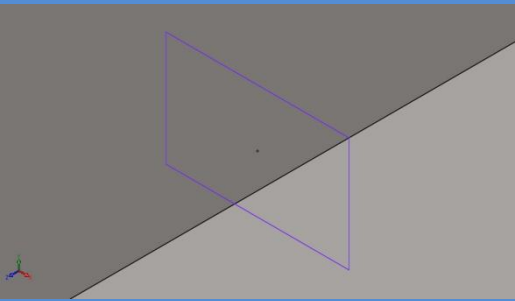
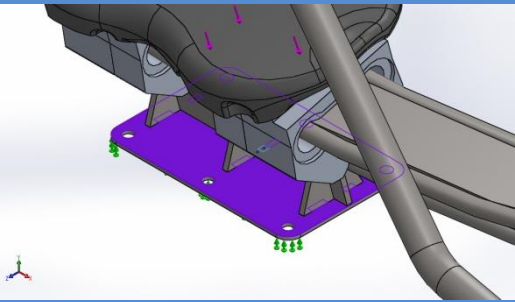
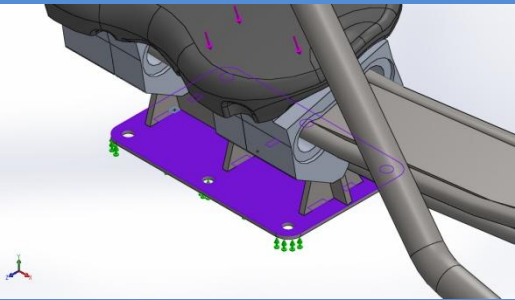
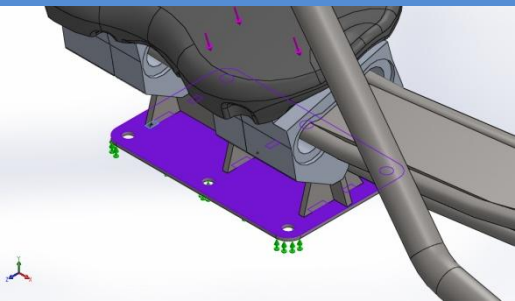
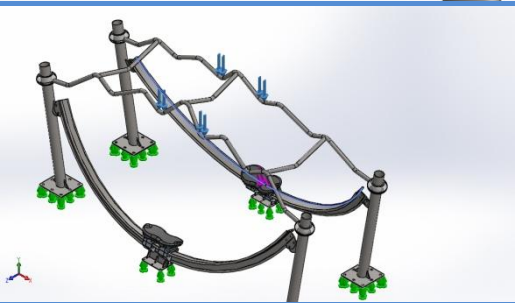
<p>Temas Seti-171</p>		<p><b>Type:</b> Bonded contact pair <b>Entites:</b> 2 face(s)</p>
<p>Temas Seti-172</p>		<p><b>Type:</b> Bonded contact pair <b>Entites:</b> 2 face(s)</p>
<p>Temas Seti-173</p>		<p><b>Type:</b> Bonded contact pair <b>Entites:</b> 2 face(s)</p>
<p>Temas Seti-174</p>		<p><b>Type:</b> Bonded contact pair <b>Entites:</b> 2 face(s)</p>
<p>Temas Seti-175</p>		<p><b>Type:</b> Bonded contact pair <b>Entites:</b> 2 face(s)</p>

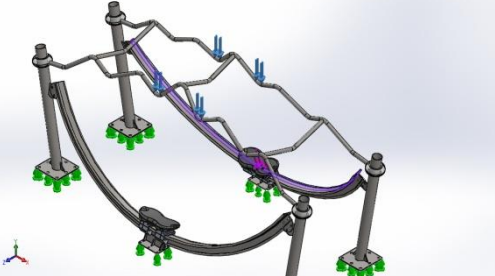
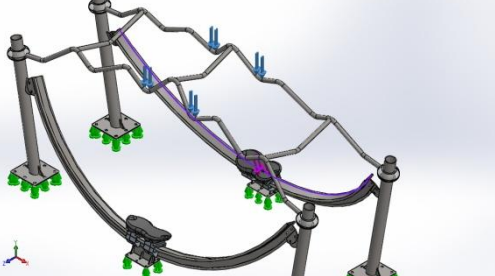
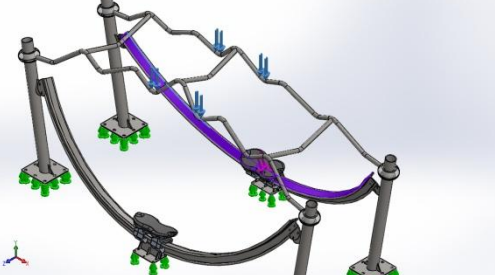
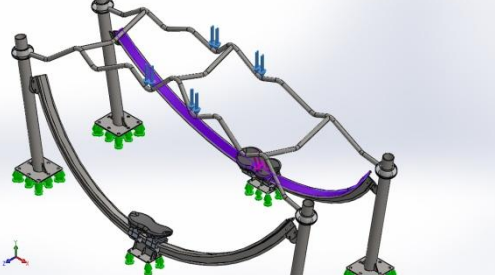
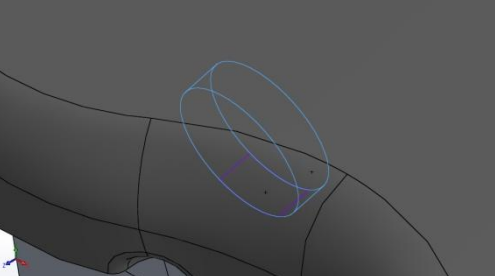

<p>Temas Seti-176</p>		<p><b>Type:</b> Bonded contact pair <b>Entites:</b> 2 face(s)</p>
<p>Temas Seti-177</p>		<p><b>Type:</b> Bonded contact pair <b>Entites:</b> 2 face(s)</p>
<p>Temas Seti-178</p>		<p><b>Type:</b> Bonded contact pair <b>Entites:</b> 2 face(s)</p>
<p>Temas Seti-179</p>		<p><b>Type:</b> Bonded contact pair <b>Entites:</b> 2 face(s)</p>
<p>Temas Seti-180</p>		<p><b>Type:</b> Bonded contact pair <b>Entites:</b> 2 face(s)</p>

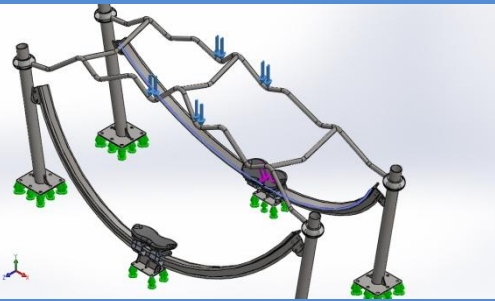
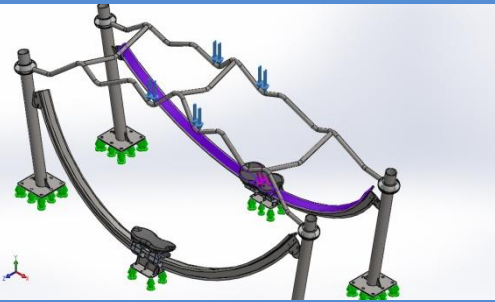
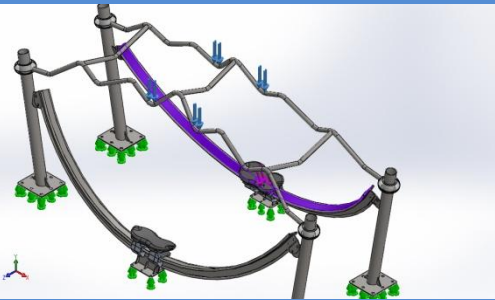
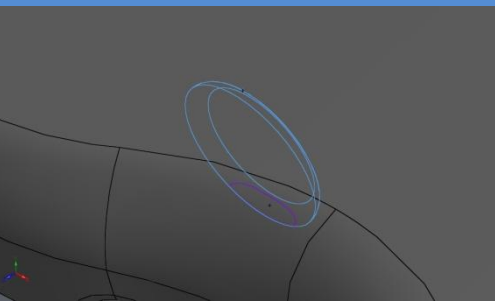
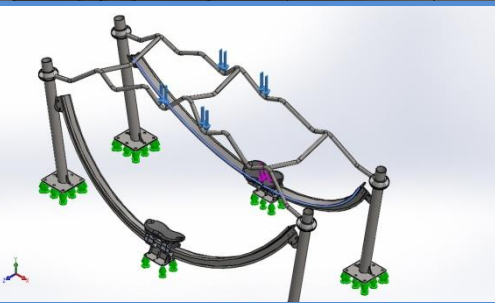

<p>Temas Seti-181</p>		<p><b>Type:</b> Bonded contact pair <b>Entites:</b> 2 face(s)</p>
<p>Temas Seti-182</p>		<p><b>Type:</b> Bonded contact pair <b>Entites:</b> 2 face(s)</p>
<p>Temas Seti-183</p>		<p><b>Type:</b> Bonded contact pair <b>Entites:</b> 2 face(s)</p>
<p>Temas Seti-184</p>		<p><b>Type:</b> Bonded contact pair <b>Entites:</b> 2 face(s)</p>
<p>Temas Seti-185</p>		<p><b>Type:</b> Bonded contact pair <b>Entites:</b> 2 face(s)</p>

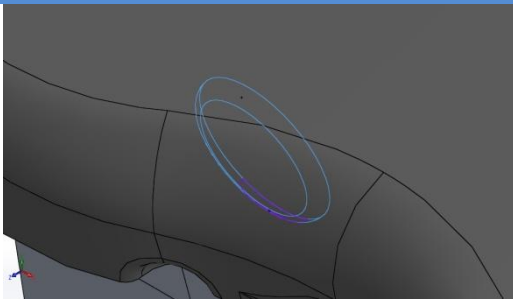
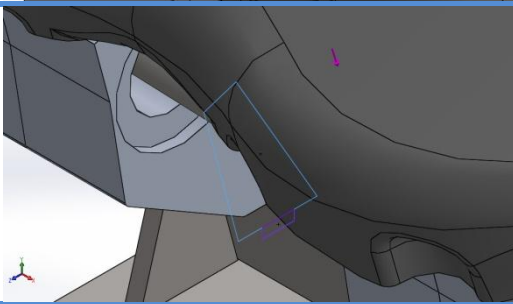
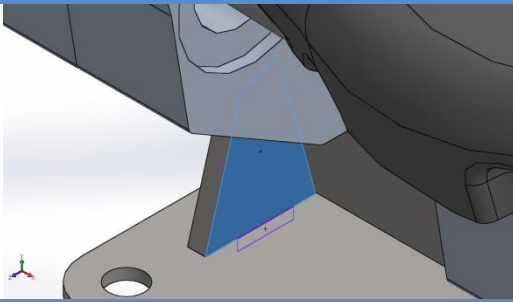
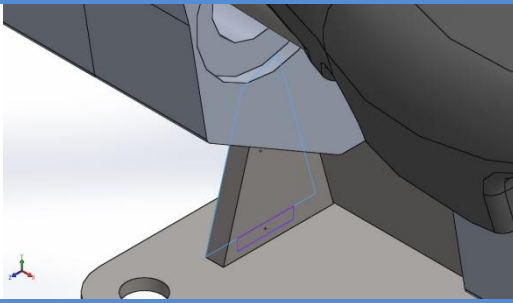
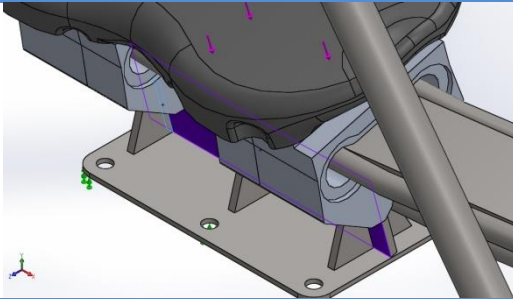
<p>Temas Seti-186</p>		<p><b>Type:</b> Bonded contact pair <b>Entites:</b> 2 face(s)</p>
<p>Temas Seti-187</p>		<p><b>Type:</b> Bonded contact pair <b>Entites:</b> 2 face(s)</p>
<p>Temas Seti-188</p>		<p><b>Type:</b> Bonded contact pair <b>Entites:</b> 2 face(s)</p>
<p>Temas Seti-189</p>		<p><b>Type:</b> Bonded contact pair <b>Entites:</b> 2 face(s)</p>
<p>Temas Seti-190</p>		<p><b>Type:</b> Bonded contact pair <b>Entites:</b> 2 face(s)</p>

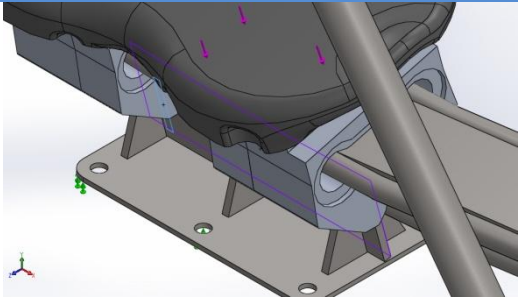
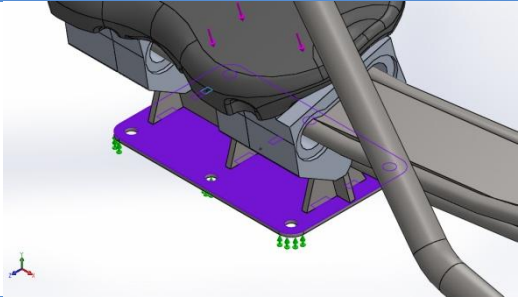
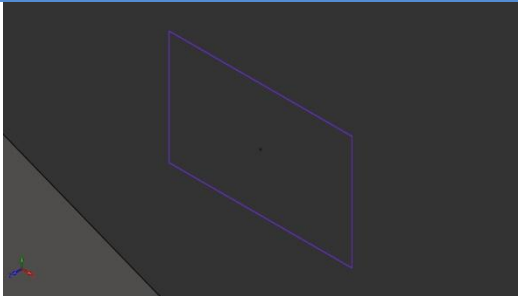
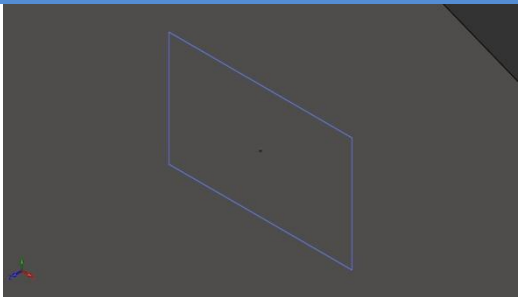
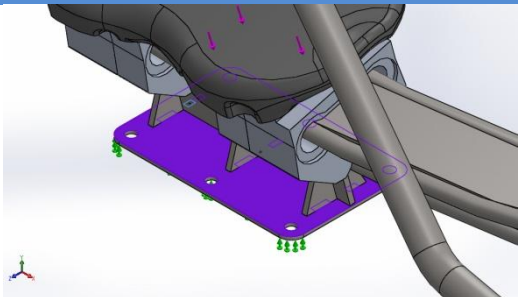
<p>Temas Seti-191</p>		<p><b>Type:</b> Bonded contact pair <b>Entites:</b> 2 face(s)</p>
<p>Temas Seti-192</p>		<p><b>Type:</b> Bonded contact pair <b>Entites:</b> 2 face(s)</p>
<p>Temas Seti-193</p>		<p><b>Type:</b> Bonded contact pair <b>Entites:</b> 2 face(s)</p>
<p>Temas Seti-194</p>		<p><b>Type:</b> Bonded contact pair <b>Entites:</b> 2 face(s)</p>
<p>Temas Seti-195</p>		<p><b>Type:</b> Bonded contact pair <b>Entites:</b> 2 face(s)</p>

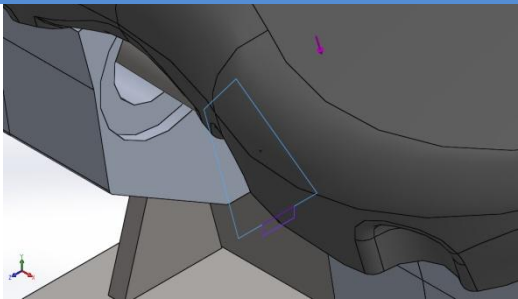
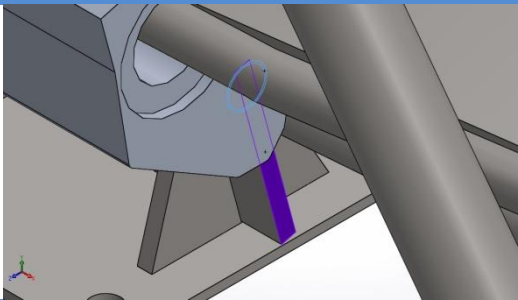
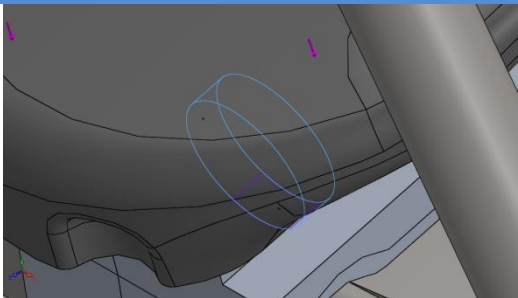
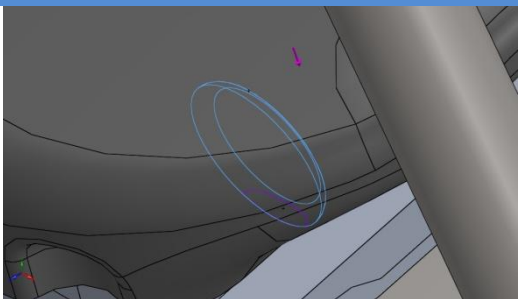
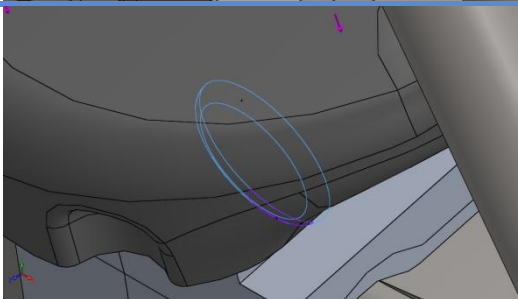
<p>Temas Seti-196</p>		<p><b>Type:</b> Bonded contact pair <b>Entites:</b> 2 face(s)</p>
<p>Temas Seti-197</p>		<p><b>Type:</b> Bonded contact pair <b>Entites:</b> 2 face(s)</p>
<p>Temas Seti-198</p>		<p><b>Type:</b> Bonded contact pair <b>Entites:</b> 2 face(s)</p>
<p>Temas Seti-199</p>		<p><b>Type:</b> Bonded contact pair <b>Entites:</b> 2 face(s)</p>
<p>Temas Seti-200</p>		<p><b>Type:</b> Bonded contact pair <b>Entites:</b> 2 face(s)</p>

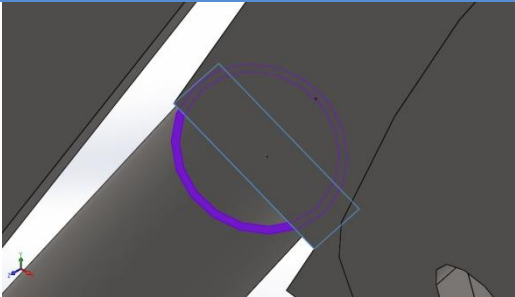
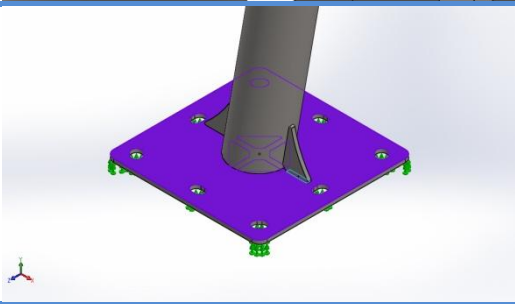
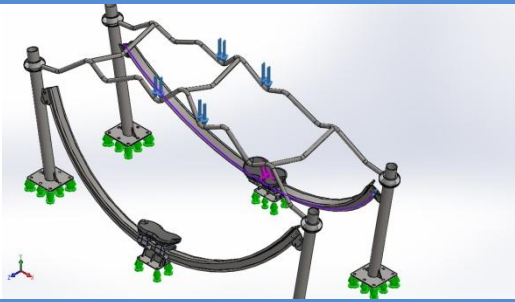
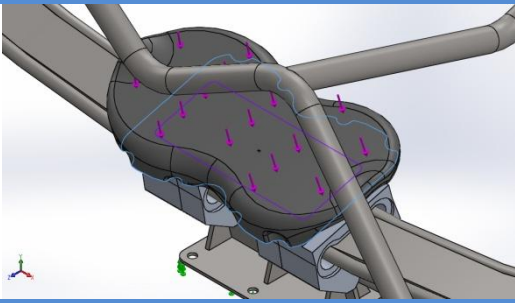
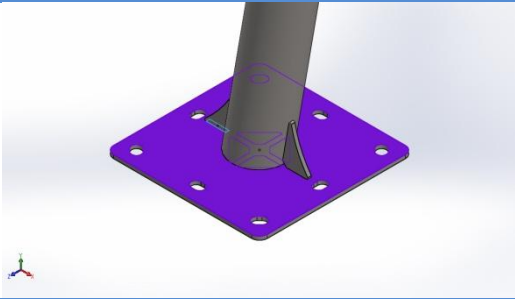
<p>Temas Seti-201</p>		<p><b>Type:</b> Bonded contact pair <b>Entites:</b> 2 face(s)</p>
<p>Temas Seti-202</p>		<p><b>Type:</b> Bonded contact pair <b>Entites:</b> 2 face(s)</p>
<p>Temas Seti-203</p>		<p><b>Type:</b> Bonded contact pair <b>Entites:</b> 2 face(s)</p>
<p>Temas Seti-204</p>		<p><b>Type:</b> Bonded contact pair <b>Entites:</b> 2 face(s)</p>
<p>Temas Seti-205</p>		<p><b>Type:</b> Bonded contact pair <b>Entites:</b> 2 face(s)</p>

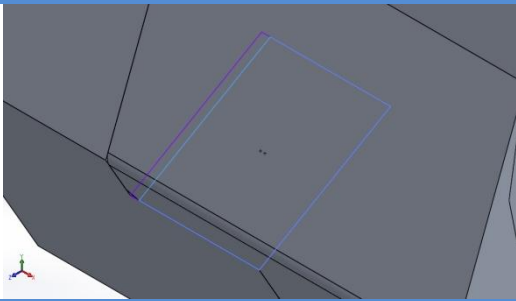
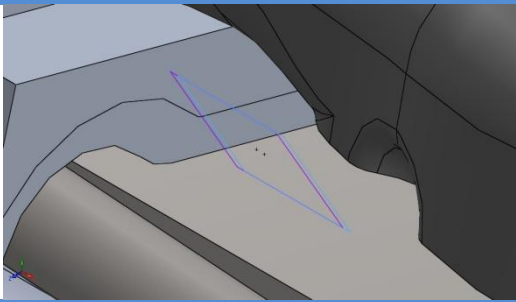
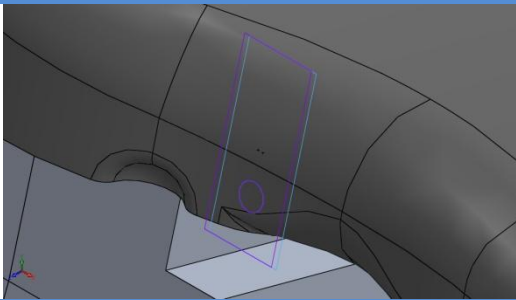
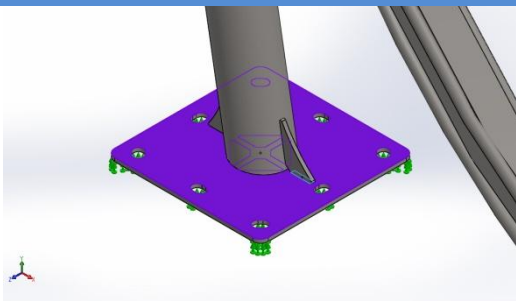
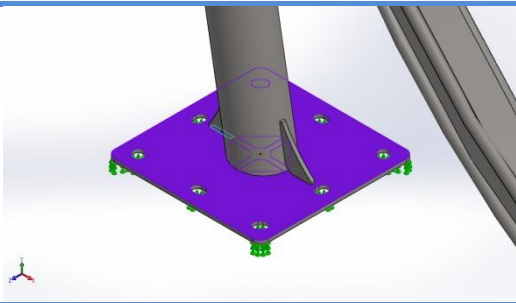
<p>Temas Seti-206</p>		<p><b>Type:</b> Bonded contact pair <b>Entites:</b> 2 face(s)</p>
<p>Temas Seti-207</p>		<p><b>Type:</b> Bonded contact pair <b>Entites:</b> 2 face(s)</p>
<p>Temas Seti-208</p>		<p><b>Type:</b> Bonded contact pair <b>Entites:</b> 2 face(s)</p>
<p>Temas Seti-209</p>		<p><b>Type:</b> Bonded contact pair <b>Entites:</b> 2 face(s)</p>
<p>Temas Seti-210</p>		<p><b>Type:</b> Bonded contact pair <b>Entites:</b> 2 face(s)</p>

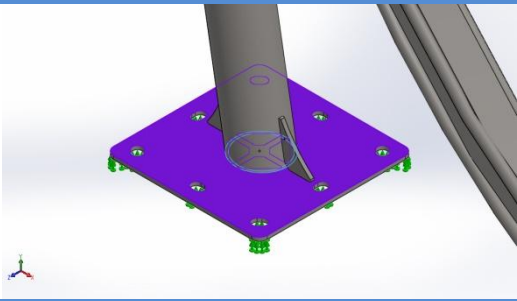
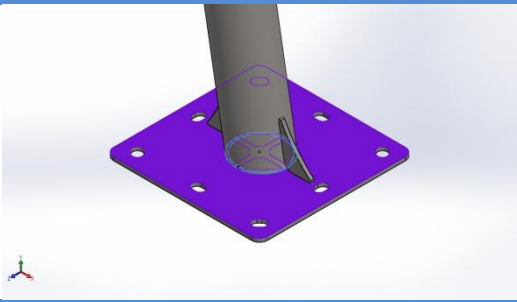
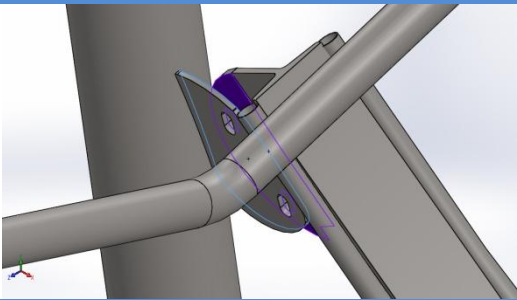
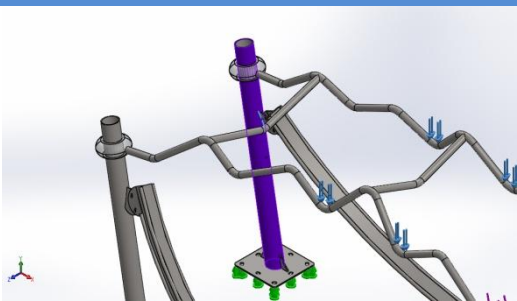
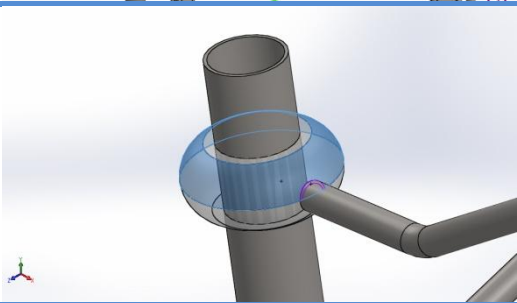

<p>Temas Seti-211</p>		<p><b>Type:</b> Bonded contact pair <b>Entites:</b> 2 face(s)</p>
<p>Temas Seti-212</p>		<p><b>Type:</b> Bonded contact pair <b>Entites:</b> 2 face(s)</p>
<p>Temas Seti-213</p>		<p><b>Type:</b> Bonded contact pair <b>Entites:</b> 2 face(s)</p>
<p>Temas Seti-214</p>		<p><b>Type:</b> Bonded contact pair <b>Entites:</b> 2 face(s)</p>
<p>Temas Seti-215</p>		<p><b>Type:</b> Bonded contact pair <b>Entites:</b> 2 face(s)</p>

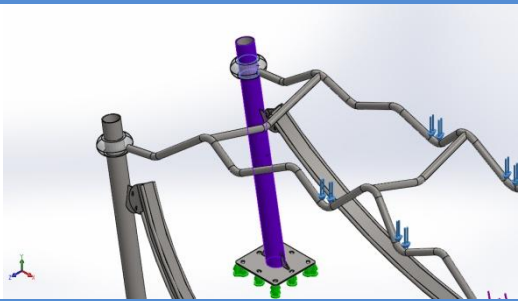
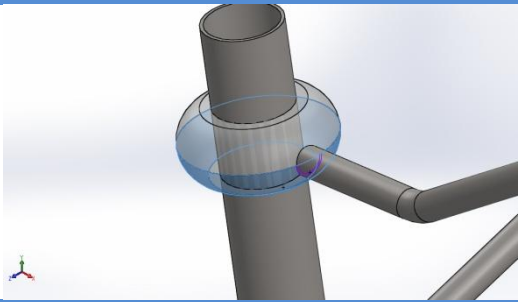
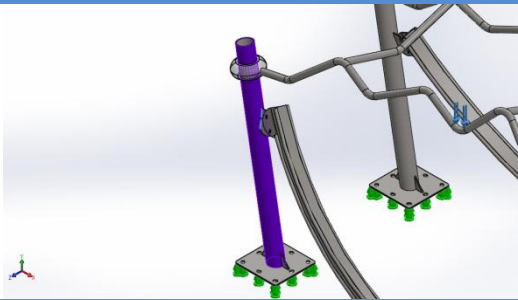
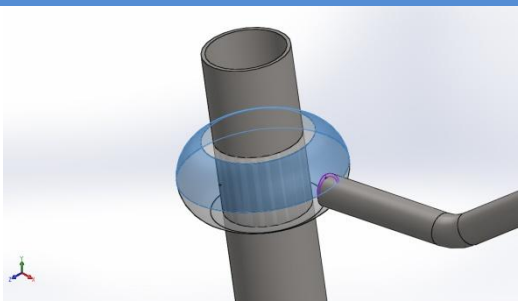
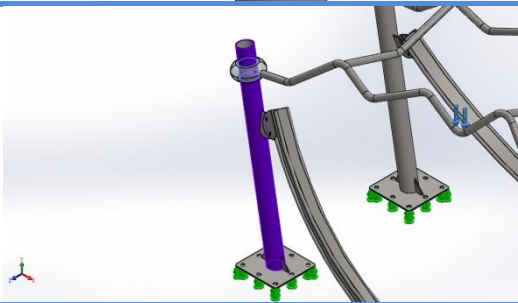

<p>Temas Seti-216</p>		<p><b>Type:</b> Bonded contact pair <b>Entites:</b> 2 face(s)</p>
<p>Temas Seti-217</p>		<p><b>Type:</b> Bonded contact pair <b>Entites:</b> 2 face(s)</p>
<p>Temas Seti-218</p>		<p><b>Type:</b> Bonded contact pair <b>Entites:</b> 2 face(s)</p>
<p>Temas Seti-219</p>		<p><b>Type:</b> Bonded contact pair <b>Entites:</b> 2 face(s)</p>
<p>Temas Seti-220</p>		<p><b>Type:</b> Bonded contact pair <b>Entites:</b> 2 face(s)</p>

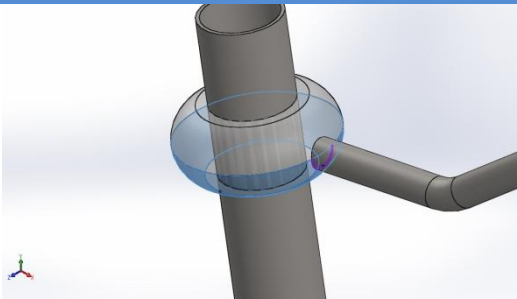
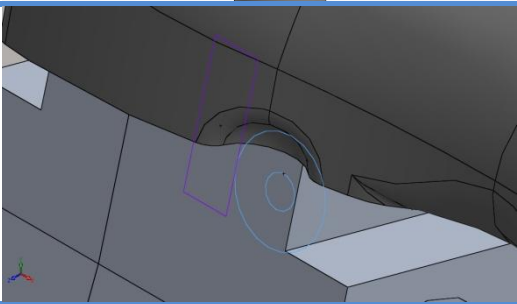
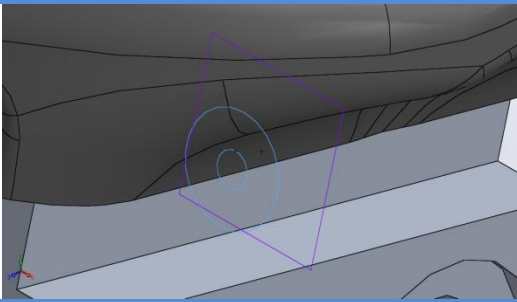
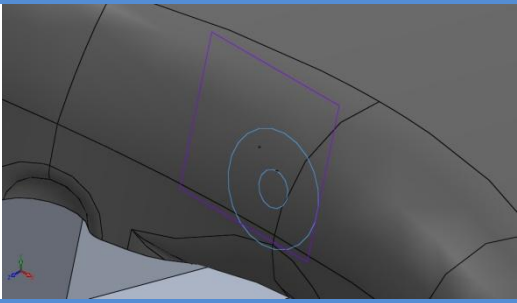
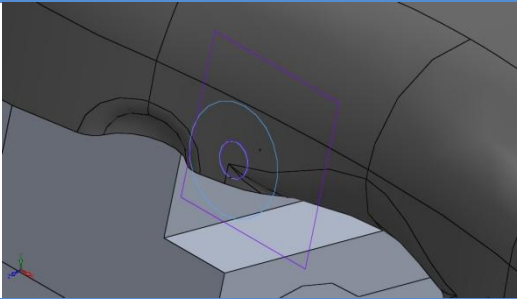
<p>Temas Seti-221</p>		<p><b>Type:</b> Bonded contact pair <b>Entites:</b> 2 face(s)</p>
<p>Temas Seti-222</p>		<p><b>Type:</b> Bonded contact pair <b>Entites:</b> 2 face(s)</p>
<p>Temas Seti-225</p>		<p><b>Type:</b> Bonded contact pair <b>Entites:</b> 2 face(s)</p>
<p>Temas Seti-229</p>		<p><b>Type:</b> Bonded contact pair <b>Entites:</b> 2 face(s)</p>
<p>Temas Seti-231</p>		<p><b>Type:</b> Bonded contact pair <b>Entites:</b> 2 face(s)</p>

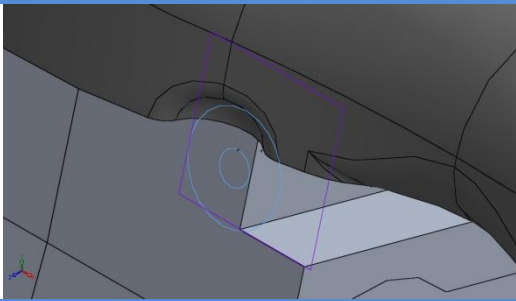
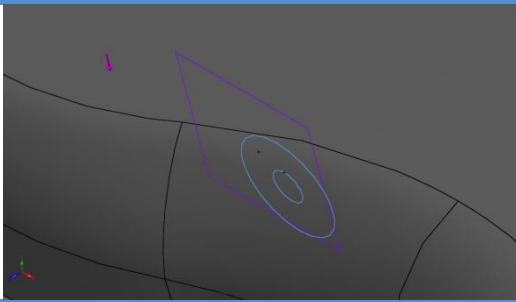
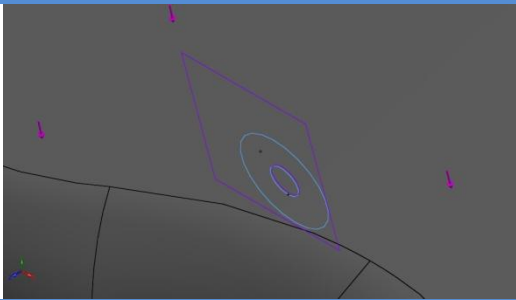
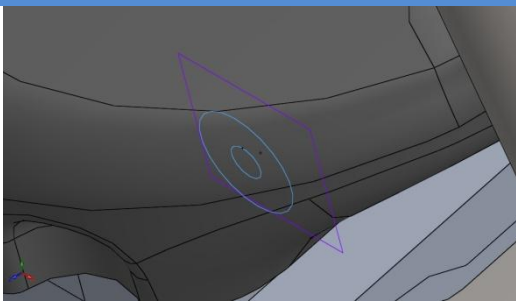
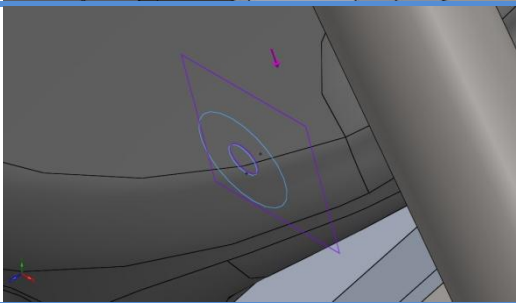
<p>Temas Seti-232</p>		<p><b>Type:</b> Bonded contact pair <b>Entites:</b> 2 face(s)</p>
<p>Temas Seti-239</p>		<p><b>Type:</b> Bonded contact pair <b>Entites:</b> 2 face(s)</p>
<p>Temas Seti-240</p>		<p><b>Type:</b> Bonded contact pair <b>Entites:</b> 2 face(s)</p>
<p>Temas Seti-247</p>		<p><b>Type:</b> Bonded contact pair <b>Entites:</b> 2 face(s)</p>
<p>Temas Seti-248</p>		<p><b>Type:</b> Bonded contact pair <b>Entites:</b> 2 face(s)</p>

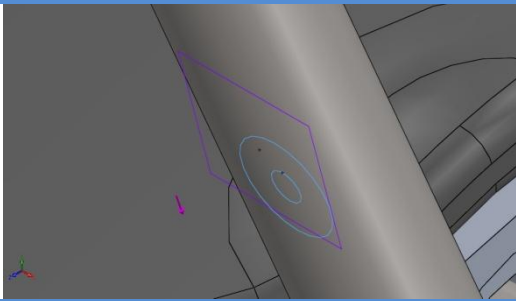
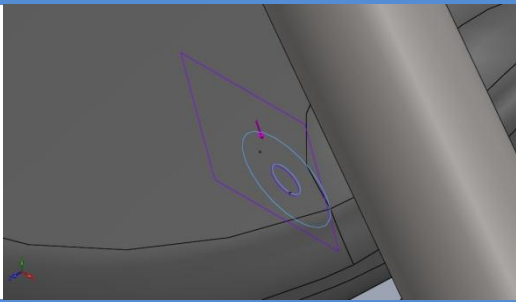
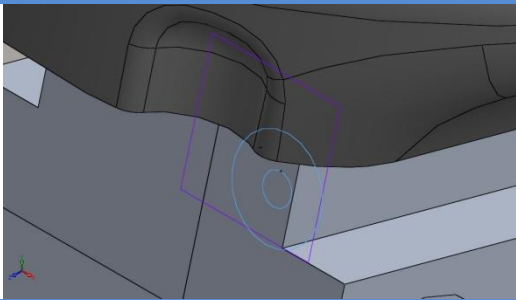
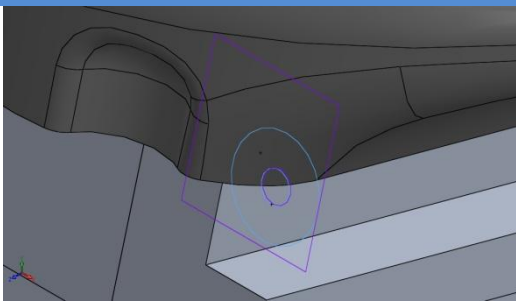

<p>Temas Seti-249</p>		<p><b>Type:</b> Bonded contact pair <b>Entites:</b> 2 face(s)</p>
<p>Temas Seti-250</p>		<p><b>Type:</b> Bonded contact pair <b>Entites:</b> 2 face(s)</p>
<p>Contact Set-252</p>		<p><b>Type:</b> Bonded contact pair <b>Entites:</b> 2 face(s)</p>
<p>Contact Set-253</p>		<p><b>Type:</b> Bonded contact pair <b>Entites:</b> 2 face(s)</p>

## Mesh Information

Mesh type	Solid Mesh
Mesher Used:	Standard mesh
Automatic Transition:	Off
Include Mesh Auto Loops:	Off
Jacobian points	4 Points
Element Size	9 mm
Tolerance	0.4 mm
Mesh Quality	Draft Quality Mesh
Remesh failed parts with incompatible mesh	Off

## Mesh Information - Details

Total Nodes	293951
Total Elements	979582
Maximum Aspect Ratio	6192.2
% of elements with Aspect Ratio < 3	73.5
% of elements with Aspect Ratio > 10	4.68
Time to complete mesh(hh:mm:ss):	00:12:52
Information	The results are not conclusive. It varies by knitting quality.



Model name: CSS ASSEMBLY LAST  
 Study name: Static 2(-Default)  
 Mesh type: Solid mesh

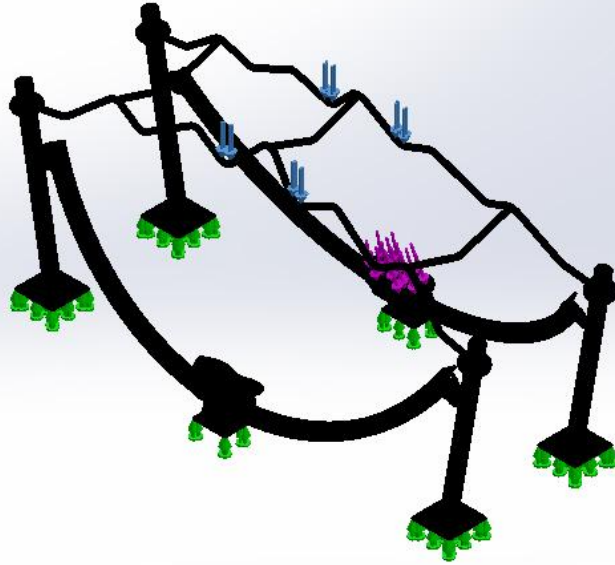



### Mesh Control Information:

Mesh Control Name	Mesh Control Image	Mesh Control Details
Kontrol-1		<b>Entities:</b> 2 component(s) <b>Units:</b> mm <b>Size:</b> 6.35901 <b>Ratio:</b> 1.5
Kontrol-2		<b>Entities:</b> 2 component(s) <b>Units:</b> mm <b>Size:</b> 6.35901 <b>Ratio:</b> 1.5

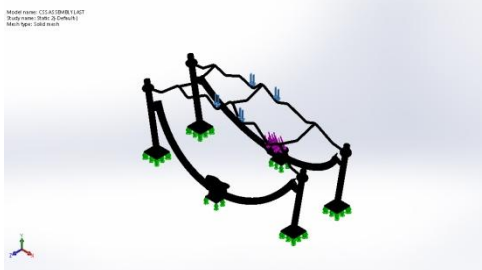
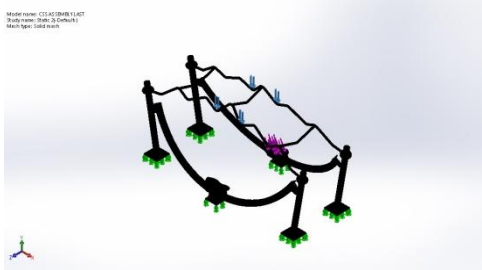
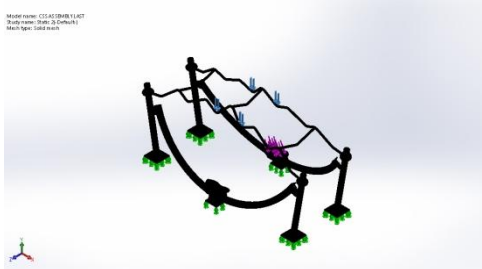
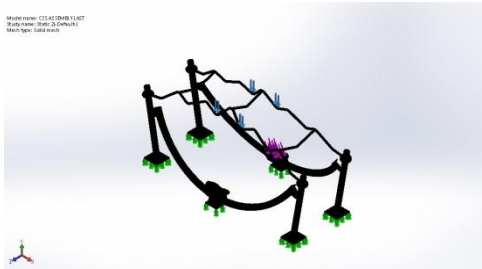
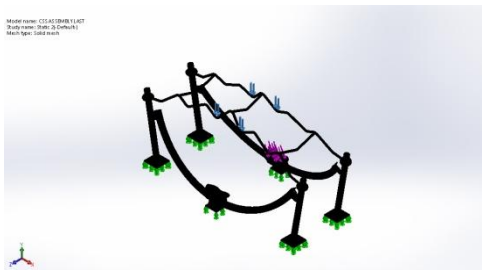

<p>Kontrol-3</p>		<p><b>Entities:</b> 2 component(s)  <b>Units:</b> mm  <b>Size:</b> 6.35901  <b>Ratio:</b> 1.5</p>
<p>Kontrol-4</p>		<p><b>Entities:</b> 2 component(s)  <b>Units:</b> mm  <b>Size:</b> 6.35901  <b>Ratio:</b> 1.5</p>
<p>Kontrol-5</p>		<p><b>Entities:</b> 2 component(s)  <b>Units:</b> mm  <b>Size:</b> 6.35901  <b>Ratio:</b> 1.5</p>
<p>Kontrol-6</p>		<p><b>Entities:</b> 2 component(s)  <b>Units:</b> mm  <b>Size:</b> 6.35901  <b>Ratio:</b> 1.5</p>
<p>Kontrol-7</p>		<p><b>Entities:</b> 2 component(s)  <b>Units:</b> mm  <b>Size:</b> 6.35901  <b>Ratio:</b> 1.5</p>

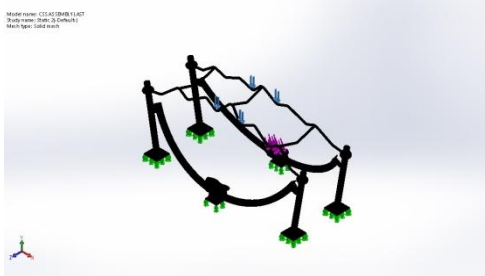
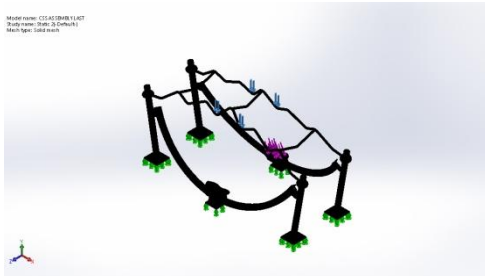
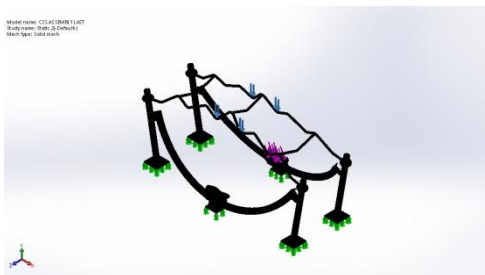

<p>Kontrol-8</p>		<p><b>Entities:</b> 2 component(s)  <b>Units:</b> mm  <b>Size:</b> 6.35901  <b>Ratio:</b> 1.5</p>
<p>Kontrol-9</p>		<p><b>Entities:</b> 2 component(s)  <b>Units:</b> mm  <b>Size:</b> 6.35894  <b>Ratio:</b> 1.5</p>
<p>Kontrol-10</p>		<p><b>Entities:</b> 2 component(s)  <b>Units:</b> mm  <b>Size:</b> 6.35901  <b>Ratio:</b> 1.5</p>
<p>Kontrol-11</p>		<p><b>Entities:</b> 2 component(s)  <b>Units:</b> mm  <b>Size:</b> 6.35901  <b>Ratio:</b> 1.5</p>
<p>Kontrol-12</p>		<p><b>Entities:</b> 2 component(s)  <b>Units:</b> mm  <b>Size:</b> 6.35901  <b>Ratio:</b> 1.5</p>

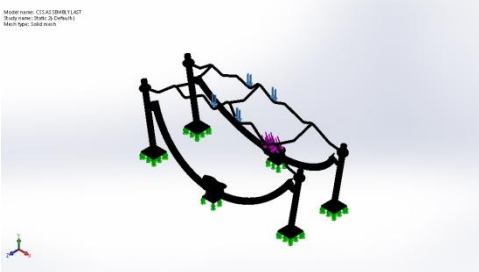
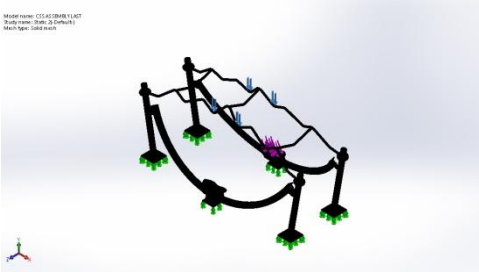
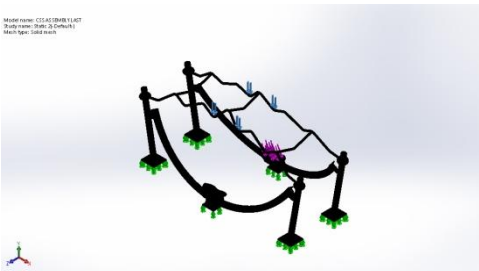
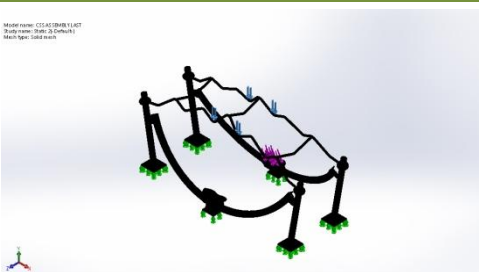
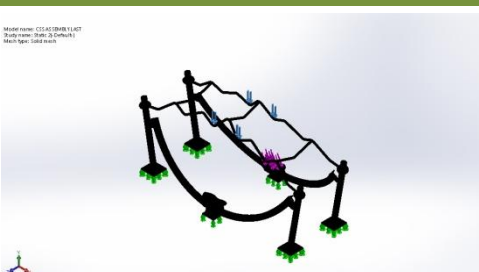
Kontrol-13		<b>Entities:</b> 2 component(s) <b>Units:</b> mm <b>Size:</b> 6.35901 <b>Ratio:</b> 1.5
Kontrol-14		<b>Entities:</b> 2 component(s) <b>Units:</b> mm <b>Size:</b> 6.35901 <b>Ratio:</b> 1.5
Kontrol-15		<b>Entities:</b> 2 component(s) <b>Units:</b> mm <b>Size:</b> 9 <b>Ratio:</b> 1
Kontrol-16		<b>Entities:</b> 2 component(s) <b>Units:</b> mm <b>Size:</b> 7 <b>Ratio:</b> 1
Kontrol-17		<b>Entities:</b> 2 component(s) <b>Units:</b> mm <b>Size:</b> 5 <b>Ratio:</b> 1

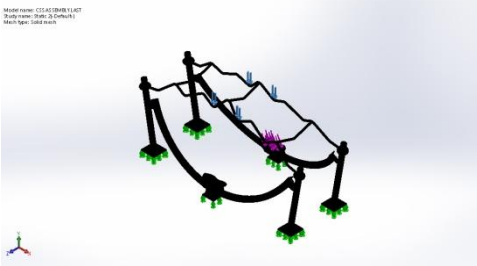
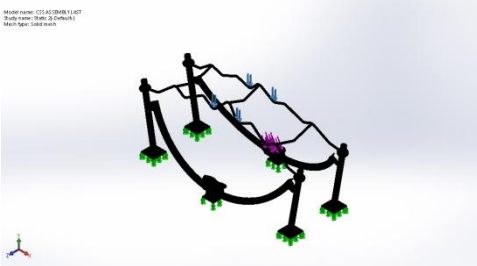
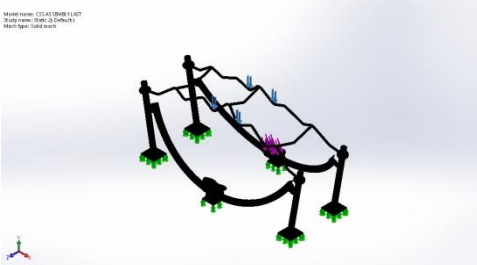
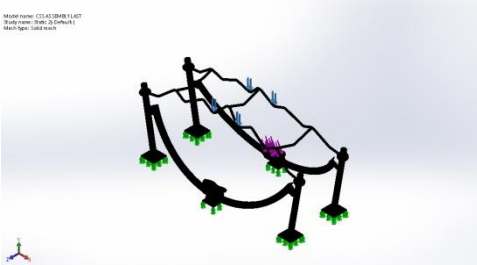
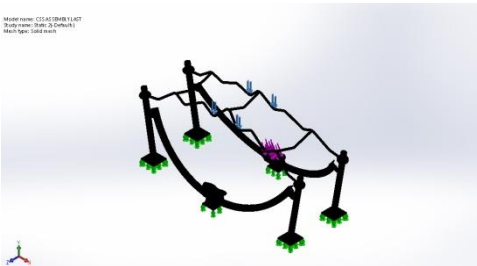
<p>Kontrol-18</p>		<p><b>Entities:</b> 2 component(s)  <b>Units:</b> mm  <b>Size:</b> 10  <b>Ratio:</b> 1</p>
<p>Kontrol-19</p>		<p><b>Entities:</b> 2 component(s)  <b>Units:</b> mm  <b>Size:</b> 12  <b>Ratio:</b> 1</p>
<p>Kontrol-20</p>		<p><b>Entities:</b> 2 component(s)  <b>Units:</b> mm  <b>Size:</b> 13  <b>Ratio:</b> 1</p>
<p>Kontrol-21</p>		<p><b>Entities:</b> 2 component(s)  <b>Units:</b> mm  <b>Size:</b> 15  <b>Ratio:</b> 1</p>
<p>Kontrol-22</p>		<p><b>Entities:</b> 2 component(s)  <b>Units:</b> mm  <b>Size:</b> 17  <b>Ratio:</b> 1</p>

Kontrol-23		<b>Entities:</b> 2 component(s) <b>Units:</b> mm <b>Size:</b> 20 <b>Ratio:</b> 1
------------	---	---

### Sensor Details

No Data

### Resultant Forces

#### Reaction Forces

Selection set	Units	Sum X	Sum Y	Sum Z	Resultant
Entire Model	N	1.68618	3333.39	-0.631949	3333.39

#### Reaction Moments

Selection set	Units	Sum X	Sum Y	Sum Z	Resultant
Entire Model	N.m	0	0	0	0

### Beams

No Data

## Study Results

Name	Type	Min	Max
Stres1	VON: von Mises Stress	2.05082e-006 N/mm <sup>2</sup> (MPa) Node: 182153	67.0188 N/mm <sup>2</sup> (MPa) Node: 5883

Model name: CSS ASSEMBLY.LAST  
 Study name: Static 2(-Default-)  
 Plot type: Static nodal stress Stres1  
 Deformation scale: 127.472

von Mises (N/mm<sup>2</sup> (MPa))

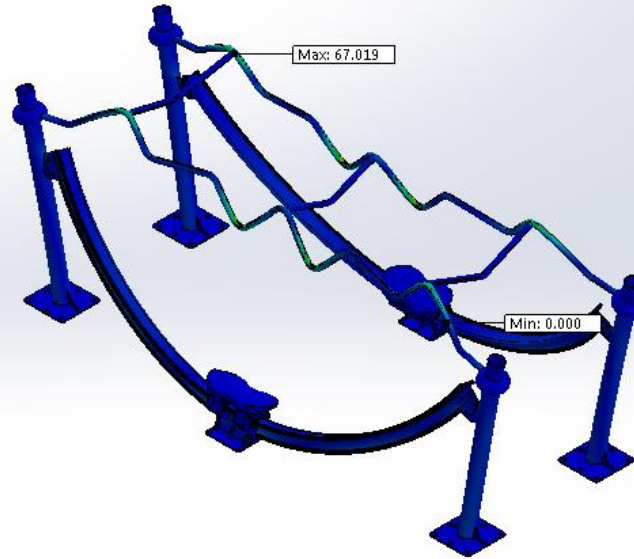
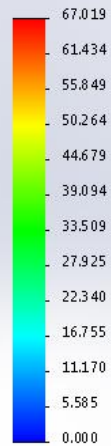

DGSS 18 - Static 1-Stress-Stres1

Name	Type	Min	Max
Dispalcement	URES: Resultant Displacement	0 mm Node: 8351	3.31158 mm Node: 139806



Model name: CSS ASSEMBLY.LAST  
 Study name: Static 2(- Default)  
 Plot type: Static displacement Yer deđiřtim e1  
 Deformation scale: 127.472

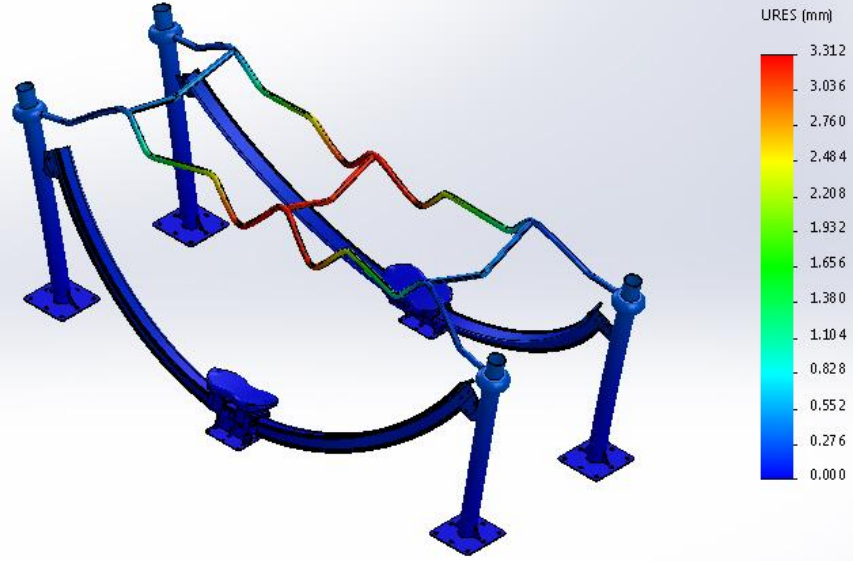

DGSS 18 - Static 1-Displacement

Name	Type	Min	Max
Strain	ESTRN: Equivalent Strain	2.86849e-012 Element: 154484	0.000485471 Element: 340431

Model name: CSS ASSEMBLY LAST  
Study name: Static 2(-Default-)  
Plot type: Static strain Gerinim1  
Deformation scale: 127.472

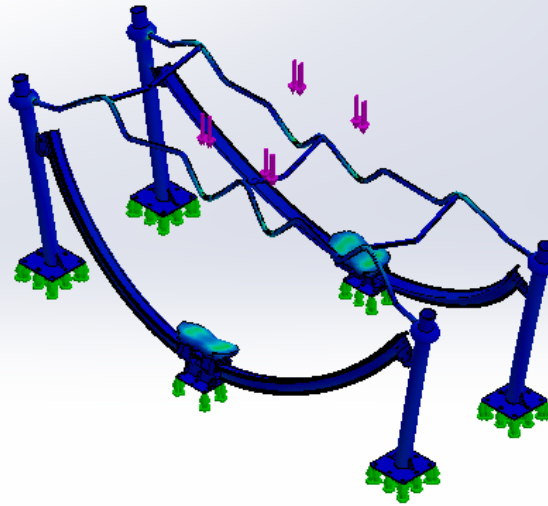
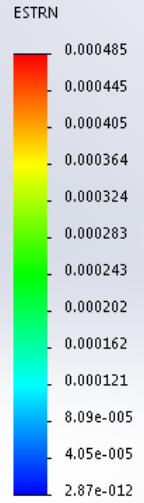

DGSS 18 - Static 1-Strain

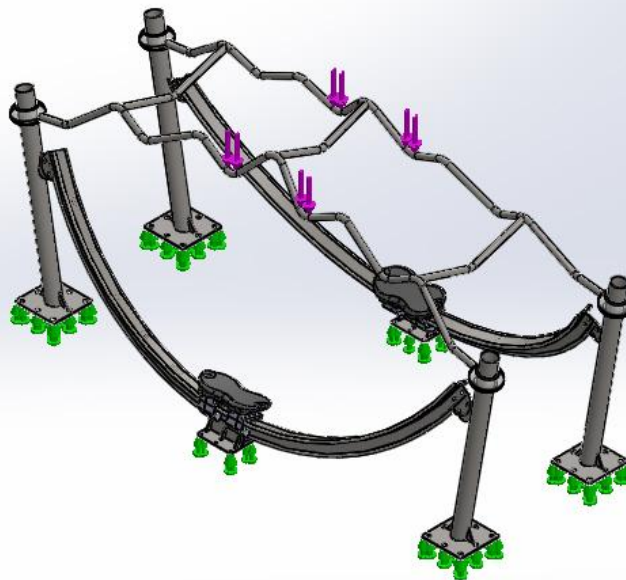

Image-1



## Conclusion

