



Cemer A.Ş olarak sadece Türkiye'de fark yaratmıyoruz, aynı zamanda dünyanın en çok tercih edilen şirketleri arasında olmaktan gurur duyuyoruz. Dünyanın her yerinden çocuklar Cemer'in yenilikçi park ekipmanları ile oynuyor, gençler ve yetişkinler açık alan fitness ekipmanları ile spor yapıyor.

As Cemer A.S, not only have we been outstanding in Turkey, but also among the most preferred companies in the world. The children of the world play on the Cemer's innovative playground equipment and the young ones work out with Cemer's outdoor fitness equipment today.



AMERICA

- UNITED STATES
- PANAMA
- COLOMBIA
- CHILE

EUROPE

- AUSTRIA
- AZERBAIJAN
- BELGIUM
- BOSNA AND HERZEGOVINA
- BULGARIA
- CROATIA
- CYPRUS

- CZECH REPUBLIC

- DENMARK

- ESTONIA

- FINLAND

- FRANCE

- GEORGIA

- GERMANY

- HUNGARY

- ICELAND

- IRELAND

- ITALY

- LATVIA

- LITHUANIA

- LUXEMBOURG

- MACEDONIA

- MOLDOVA

- MONTENEGRO

- NETHERLAND

- NORWAY

- POLAND

- PORTUGAL

- ROMANIA

- SCOTLAND

- SERBIA

- SLOVAKIA

- SLOVENIA

- SPAIN

- SWEDEN

- SWITZERLAND

- UKRAINE

- UNITED KINGDOM

ASIA

- BAHRAIN

- CHINA

- IRAN

- IRAQ

- ISRAEL

- JAPAN

- KAZAKHISTAN

- LEBANON

- MALAYSIA

- OMAN

- PHILIPPINES

- QATAR

- RUSSIA

- SAUDI ARABIA

- SINGAPORE

- SYRIA

- TURKEY

- TURKMENISTAN

- UNITED ARAB EMIRATES

- VIETNAM

AFRICA

- ALGERIA

- EGYPT

- LIBYA

- MOROCCO

OCEANIA

- AUSTRALIA

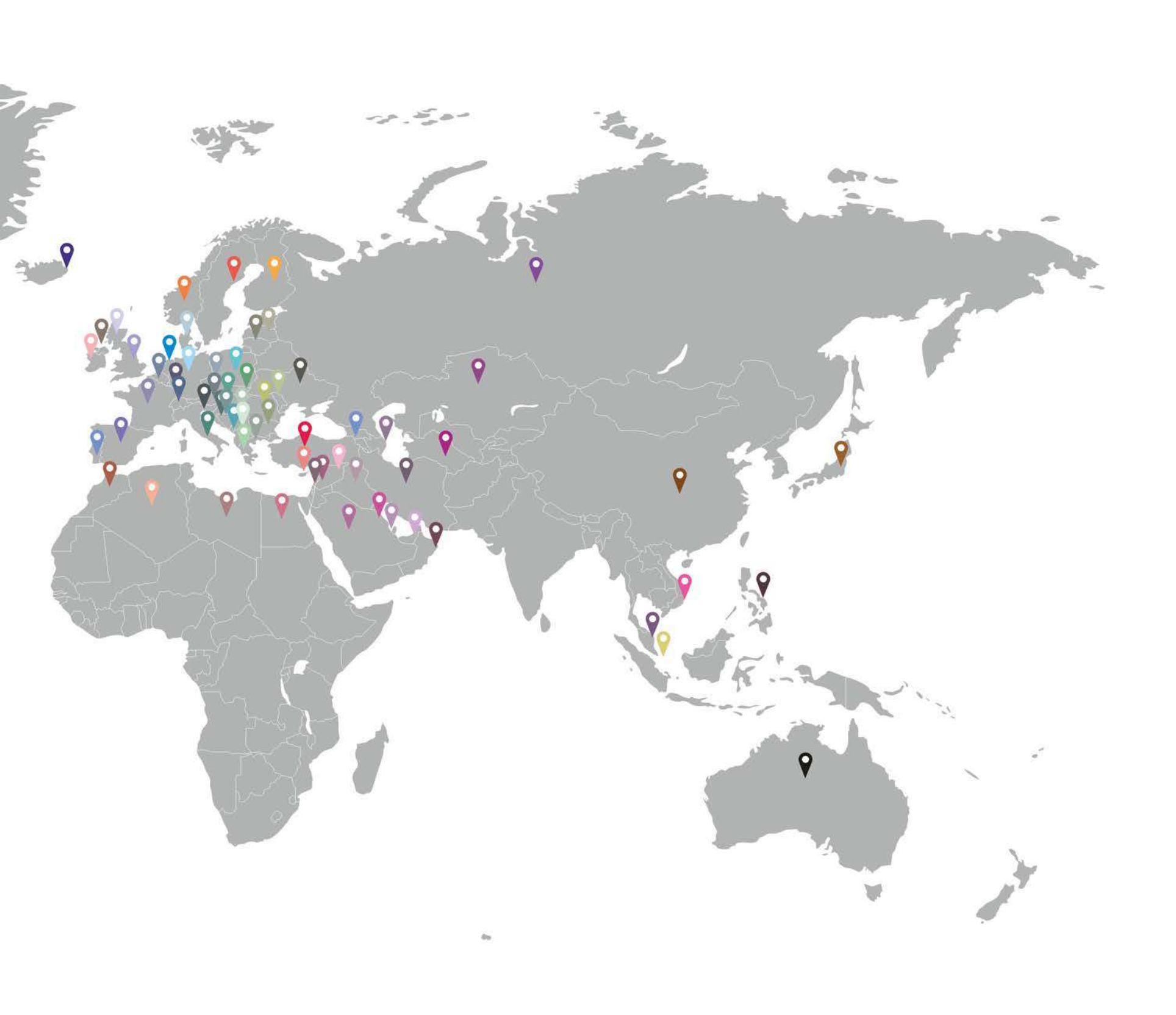



“düştten gerçeğe”

Oyun, çocukların sosyal uyum, zeka ve becerilerini geliştiren, belirli bir yer ve zaman içerisinde, kendine özgü kurallarla yapılan, çocukların dinlenmelerini ve öğrenmelerini sağlayan eğlenceli bir etkinliktir.

Oyun, çocuğun isteklerini, amaçlarını anlatan, toplumsal hayata hazırlayan en etkili araçlardandır.

Çocuğun devamlı oynama isteği, onun geleceğe yönelik hareketlerinin ifadesidir. Özellikle mücadele oyunları içinde çocuklar sürekli olarak koşmak, zıplamak, tırmanmak, çekmek, itmek, boğuşmak gibi vücut özellikleriyle mücadele etmek durumundadırlar.

Çocuk, sahip olduğu fiziksel yetenekleriyle diğer oyunculara karşı bir yarış halindedir. Bu mücadele nedeniyle yapmış olduğu hareketlilik sayesinde, öncelikle solunum, dolaşım ve sindirim sistemi olumlu etkilenir. Ayrıca iç salgı bezlerinden daha fazla salgılama yapılmasına katkıda bulunarak çocuğun gelişmesini hızlandırır.



The game is a fun activity with its own rules that develops children's social cohesion, intelligence and skills, and allows them to relax and learn in a certain place and time.

The game is one of the most effective means that describe the child's wishes and aims, and prepare them for social life.

The constant desire of a child to play is an expression of his future interests and development. Especially during competitive games, children exercise body motions like running, jumping, climbing, pulling, pushing and wrestling non-stop.

The child is in a race against other players with his physical abilities. Because of this activity, breathing, circulation and digestive system are positively affected. It also accelerates the development of the child by increasing the secretion of the glands..



“dreams come true”





OYUN ALANI SETLERİ/ SAMPLE LAYOUTS	4	-	9
TEMALI OYUN GRUPLARI/ THEMED PLAYGROUNDS	10	-	83
coco jambo serisi/ coco jambo series	12	-	13
mercan serisi/ coral series	14	-	15
mekanik serisi/ mechanical series	16	-	17
karaorman serisi/ blackforest series	18	-	19
yeraltı serisi/ underground series	20	-	21
castello serisi/ castello series	22	-	23
kale serisi/ castle series	24	-	27
gemi serisi/ ship series	28	-	31
robot serisi/ robot series	32	-	35
uçak serisi/ plane series	36	-	39
araç serisi/ vehicle series	40	-	41
gökkuşağı serisi/ rainbow series	42	-	83
İÇ MEKAN OYUN GRUPLARI/ INDOOR PLAYGROUNDS	84	-	89
MODÜLER TIRMANMA/ MODULAR CLIMBING	90	-	125
deltoik tırmanma/ deltoik climbing	92	-	99
luna tırmanma/ luna climbing	100	-	100
astero tırmanma/ astero climbing	101	-	104
denge tırmanma/ balance climbing	105	-	111
burgu tırmanma/ gimlet climbing	112	-	115
duvar tırmanma/ bouldering	116	-	123
silver serisi/ silver series	124	-	125
AKSESUARLAR/ ACCESSORIES	126	-	149
KENT EKİPMANLARI/ URBAN EQUIPMENT	150	-	161
classico kent ekipmanları/ classico urban equipment	152	-	155
3d epdm kauçuk hayvan figürleri/ 3d epdm rubber animal figures	156	-	157
zemin kaplama/ ground coating	158	-	161
DIŞ MEKAN SPOR ALETLERİ/ OUTDOOR FITNESS EQUIPMENT	162	-	191
yetişkinler için fitness/ adult fitness	164	-	179
reklam panolu fitness/ billboard fitness	180	-	182
fitness setleri/ fitness sets	183	-	183
engelliler için fitness/ hadicapped fitness	184	-	185
çocuklar için fitness/ children fitness	186	-	191



OYUN ALANI SETLERİ SAMPLE LAYOUTS

SET 70
589 m²



SET 71
568 m²

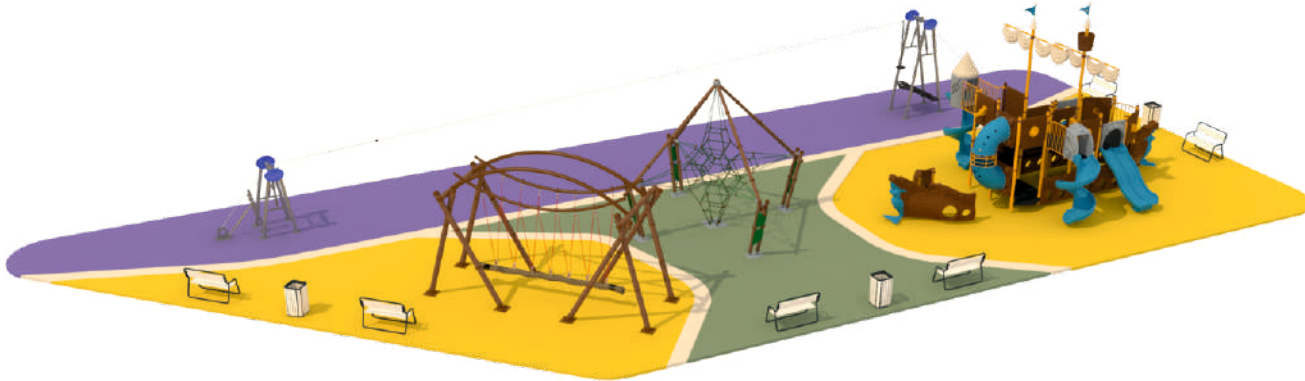

SET 72
437 m²



SET 73
288 m²



SET 74
270 m²



SET 75
269 m²



SET 76
250 m²



SET 77
213 m²

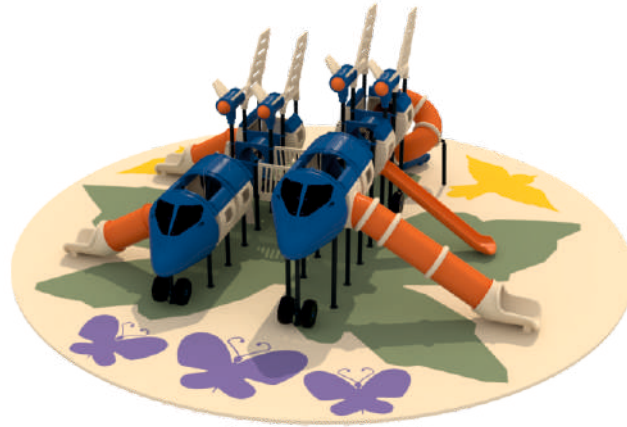

SET 78
209 m²





SET 79
196 m²



SET 80
193 m²

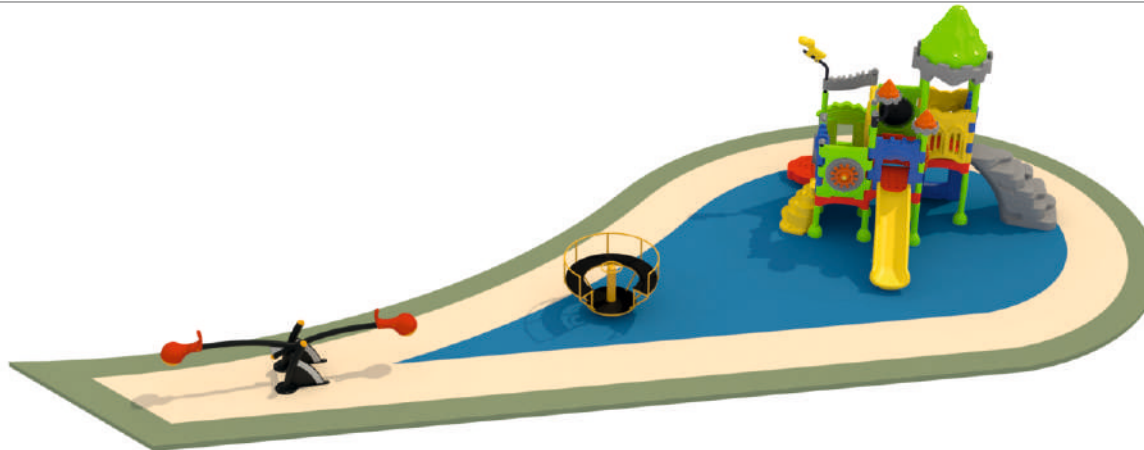

SET 81
95 m²

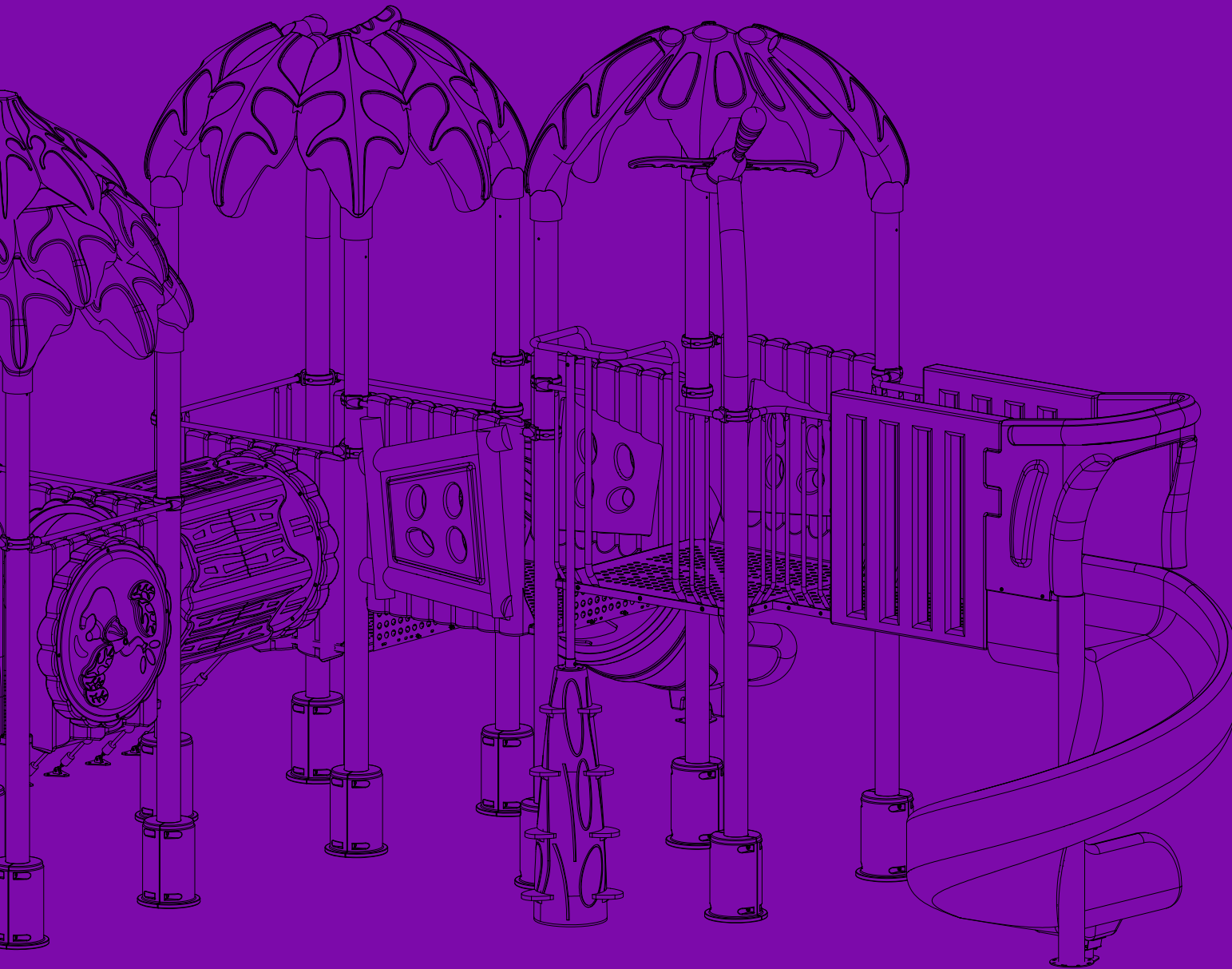

TEMALI OYUN GRUPLARI THEMED PLAYGROUNDS

12	COCO JAMBO SERİSİ	COCO JAMBO SERIES	12
14	MERCAN SERİSİ	CORAL SERIES	14
16	MEKANİK SERİ	MECHANICAL SERIES	16
18	KARAORMAN SERİSİ	BLACKFOREST SERIES	18
20	YERALTI SERİSİ	UNDERGROUND SERIES	20
22	CASTELLO SERİSİ	CASTELLO SERIES	22
24	KALE SERİSİ	CASTLE SERIES	24
28	GEMİ SERİSİ	SHIP SERIES	28
32	ROBOT SERİSİ	ROBOT SERIES	32
36	UÇAK SERİSİ	PLANE SERIES	36
40	ARAÇ SERİSİ	VEHICLE SERIES	40
42	GÖKKUŞAĞI SERİSİ	RAINBOW SERIES	42

CJS 101

**NEW
PRODUCT**



Age / Yaş: 3+
Capacity / Kapasite: 21
Fall height / Max. düşme yüksekliği: 1,5 m
Safety area / Güvenlik alanı: 61,7 m²

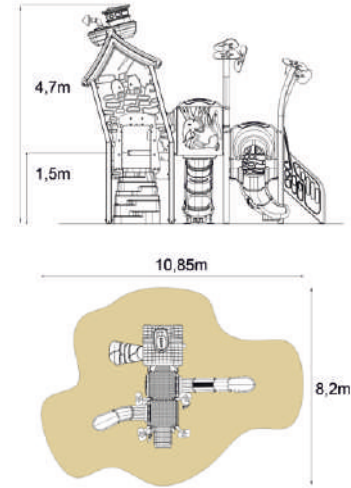

CJS 102

**NEW
PRODUCT**



Age / Yaş: 3+
Capacity / Kapasite: 19
Fall height / Max. düşme yüksekliği: 1,5 m
Safety area / Güvenlik alanı: 61,4 m²

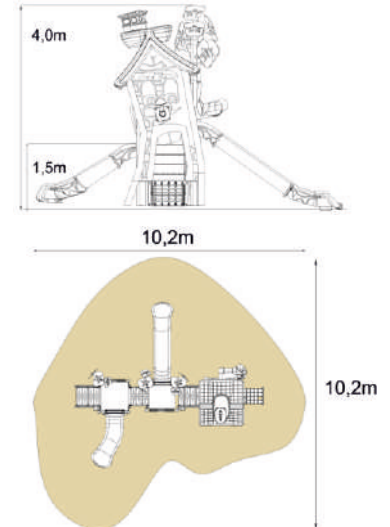

Age / Yaş: 3+
 Capacity / Kapasite: 27
 Fall height / Max. düşme yüksekliği: 1,5 m
 Safety area / Güvenlik alanı: 66,9 m²

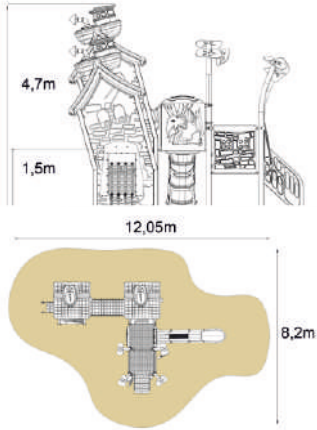

CJS 103

**NEW
PRODUCT**

coco jambo serisi/ coco jambo series

TEMALI OYUN GRUPLARI/
THEMED PLAYGROUNDS

Age / Yaş: 3+
 Capacity / Kapasite: 73
 Fall height / Max. düşme yüksekliği: 1,5 m
 Safety area / Güvenlik alanı: 165 m²

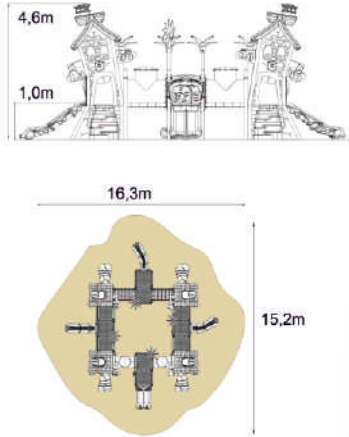

CJS 104

**NEW
PRODUCT**

MS 101

**NEW
PRODUCT**



Age / Yaş: 3+
Capacity / Kapasite: 16
Fall height / Max. düşme yüksekliği: 1,0 m
Safety area / Güvenlik alanı: 59,9 m²

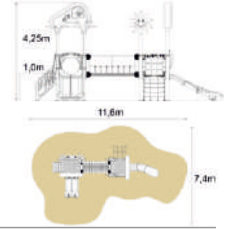

MS 102

**NEW
PRODUCT**



Age / Yaş: 3+
Capacity / Kapasite: 29
Fall height / Max. düşme yüksekliği: 1,5 m
Safety area / Güvenlik alanı: 80,6 m²

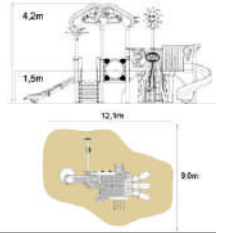

MS 103

**NEW
PRODUCT**



Age / Yaş: 3+
Capacity / Kapasite: 26
Fall height / Max. düşme yüksekliği: 1,5 m
Safety area / Güvenlik alanı: 77 m²

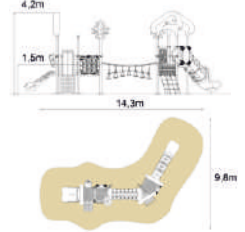

MS 104

**NEW
PRODUCT**



Age / Yaş: 3+
Capacity / Kapasite: 25
Fall height / Max. düşme yüksekliği: 1,5 m
Safety area / Güvenlik alanı: 97,8 m²

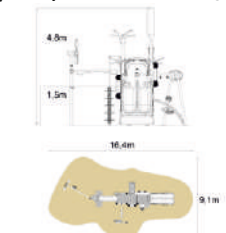

Age / Yaş: 3+
Capacity / Kapasite: 35
Fall height / Max. düşme yüksekliği: 1,5 m
Safety area / Güvenlik alanı: 110,2 m²

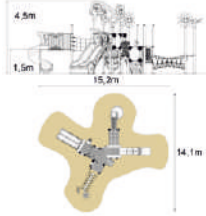

MS 105

**NEW
PRODUCT**

mercator serisi/ coral series
TEMALI OYUN GRUPLARI/
THEMED PLAYGROUNDS



MES 101

**NEW
PRODUCT**



Age / Yaş: 3+
Capacity / Kapasite: 35
Fall height / Max. düşme yüksekliği: 2,0 m
Safety area / Güvenlik alanı: 99,9 m²

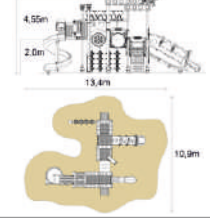

MES 102

**NEW
PRODUCT**



Age / Yaş: 3+
Capacity / Kapasite: 48
Fall height / Max. düşme yüksekliği: 1,5 m
Safety area / Güvenlik alanı: 118,1 m²

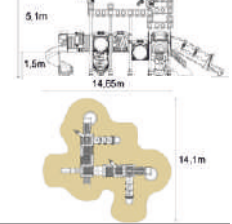

MES 103

**NEW
PRODUCT**



Age / Yaş: 3+
Capacity / Kapasite: 43
Fall height / Max. düşme yüksekliği: 1,0 m
Safety area / Güvenlik alanı: 108,5 m²

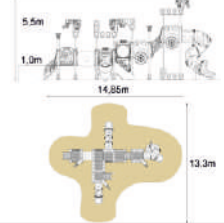

MES 104

**NEW
PRODUCT**



Age / Yaş: 3+
Capacity / Kapasite: 58
Fall height / Max. düşme yüksekliği: 2,0 m
Safety area / Güvenlik alanı: 167,9 m²

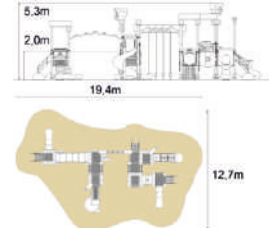

Age / Yaş: 3+
Capacity / Kapasite: 44
Fall height / Max. düşme yüksekliği: 2,0 m
Safety area / Güvenlik alanı: 136,2 m²

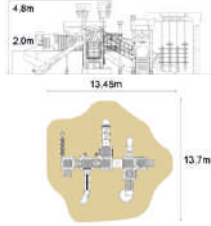

MES 105

**NEW
PRODUCT**

mekanik serisi/ mechanical series
TEMALI OYUN GRUPLARI/
THEMED PLAYGROUNDS



KS 101

**NEW
PRODUCT**



Age / Yaş: 3+
Capacity / Kapasite: 26
Fall height / Max. düşme yüksekliği: 1,5 m
Safety area / Güvenlik alanı: 87,8 m²

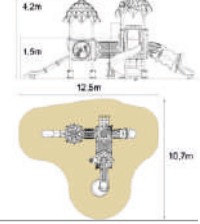

KS 102

**NEW
PRODUCT**



Age / Yaş: 3+
Capacity / Kapasite: 87
Fall height / Max. düşme yüksekliği: 2,0 m
Safety area / Güvenlik alanı: 210,2 m²

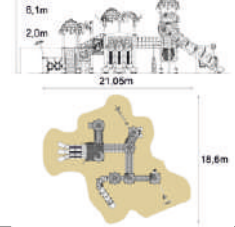

KS 103

**NEW
PRODUCT**



Age / Yaş: 3+
Capacity / Kapasite: 42
Fall height / Max. düşme yüksekliği: 1,5 m
Safety area / Güvenlik alanı: 135,5 m²

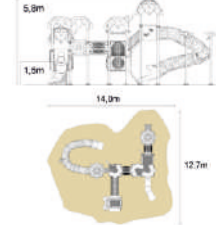

KS 104

**NEW
PRODUCT**



Age / Yaş: 3+
Capacity / Kapasite: 78
Fall height / Max. düşme yüksekliği: 2,0 m
Safety area / Güvenlik alanı: 191,3 m²

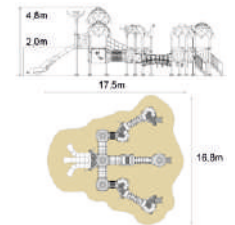

Age / Yaş: 3+
Capacity / Kapasite: 57
Fall height / Max. düşme yüksekliği: 2,0 m
Safety area / Güvenlik alanı: 180,2 m²

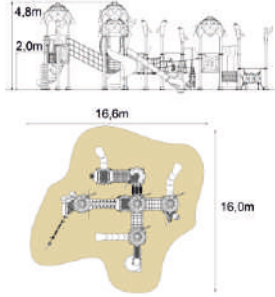

KS 105

NEW
PRODUCT

karaorman serisi/ blackforest series
TEMALI OYUN GRUPLARI/
THEMED PLAYGROUNDS

Age / Yaş: 3+
Capacity / Kapasite: 32
Fall height / Max. düşme yüksekliği: 2,0 m
Safety area / Güvenlik alanı: 107,8 m²

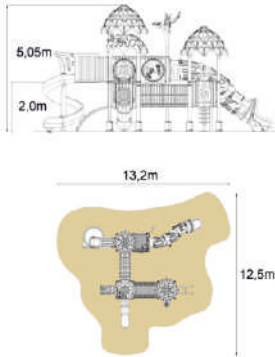

KS 106

NEW
PRODUCT

Age / Yaş: 3+
Capacity / Kapasite: 30
Fall height / Max. düşme yüksekliği: 1,5 m
Safety area / Güvenlik alanı: 80,9 m²

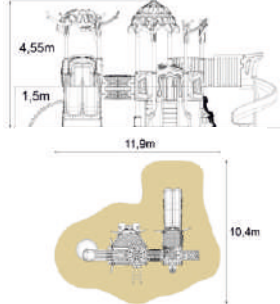

KS 107

NEW
PRODUCT

YS 101

**NEW
PRODUCT**



Age / Yaş: 3+
Capacity / Kapasite: 52
Fall height / Max. düşme yüksekliği: 2,5 m
Safety area / Güvenlik alanı: 134,5 m²

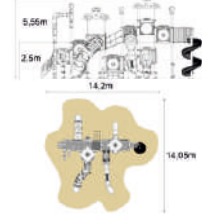

YS 102

**NEW
PRODUCT**



Age / Yaş: 3+
Capacity / Kapasite: 55
Fall height / Max. düşme yüksekliği: 1,5 m
Safety area / Güvenlik alanı: 138,5 m²

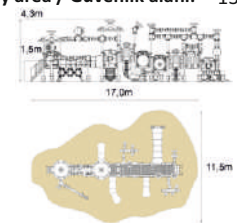

YS 103

**NEW
PRODUCT**



Age / Yaş: 3+
Capacity / Kapasite: 53
Fall height / Max. düşme yüksekliği: 2,0 m
Safety area / Güvenlik alanı: 136,5 m²

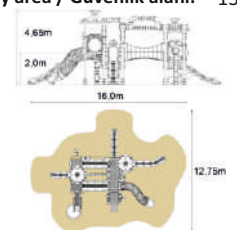

YS 104

**NEW
PRODUCT**



Age / Yaş: 3+
Capacity / Kapasite: 33
Fall height / Max. düşme yüksekliği: 2,0 m
Safety area / Güvenlik alanı: 115,7 m²

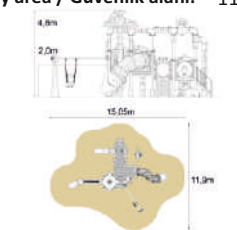

Age / Yaş: 3+
Capacity / Kapasite: 54
Fall height / Max. düşme yüksekliği: 1,5 m
Safety area / Güvenlik alanı: 144,5 m²

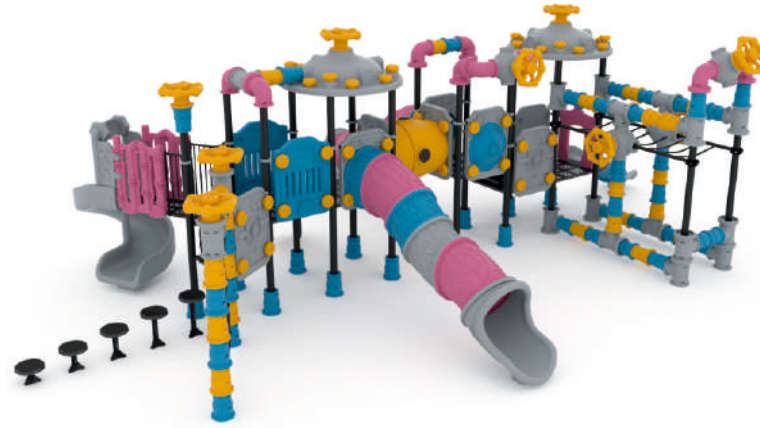
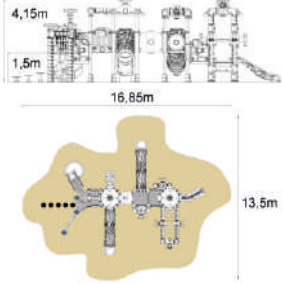

YS 105

**NEW
PRODUCT**

yeraltı serisi/ underground series
**TEMALİ OYUN GRUPLARI/
THEMED PLAYGROUNDS**



CAS 101
**NEW
PRODUCT**



Age / Yaş: 3+
Capacity / Kapasite: 21
Fall height / Max. düşme yüksekliği: 1,25 m
Safety area / Güvenlik alanı: 40,9 m²

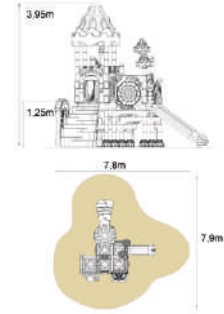

CAS 102
**NEW
PRODUCT**



Age / Yaş: 3+
Capacity / Kapasite: 13
Fall height / Max. düşme yüksekliği: 1,0 m
Safety area / Güvenlik alanı: 31,3 m²

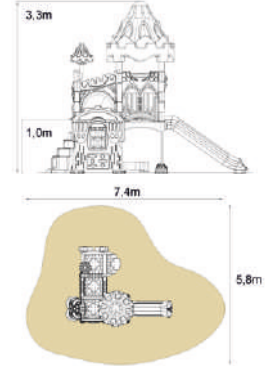

CAS 103
**NEW
PRODUCT**



Age / Yaş: 3+
Capacity / Kapasite: 7
Fall height / Max. düşme yüksekliği: 1,0 m
Safety area / Güvenlik alanı: 24,3 m²

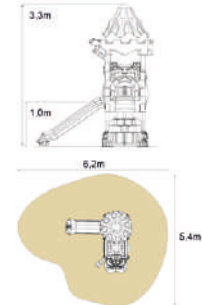



castello serjisi / castello series

TEMALI OYUN GRUPLARI/
THEMED PLAYGROUNDS

1K 352



Age / Yaş: 3+
Capacity / Kapasite: 22
Fall height / Max. düşme yüksekliği: 1,5 m
Safety area / Güvenlik alanı: 64,7 m²

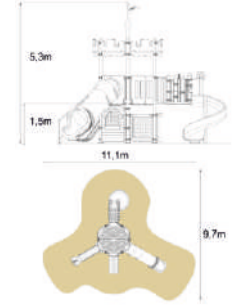

2K 353-1



Age / Yaş: 3+
Capacity / Kapasite: 14
Fall height / Max. düşme yüksekliği: 1,5 m
Safety area / Güvenlik alanı: 58,4 m²

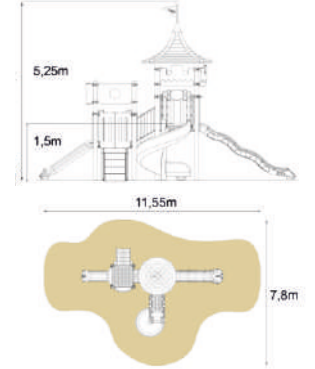

3K 307-3



Age / Yaş: 3+
Capacity / Kapasite: 17
Fall height / Max. düşme yüksekliği: 2,0 m
Safety area / Güvenlik alanı: 50,8 m²

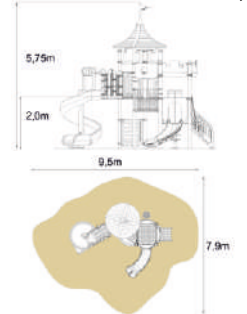



kale serisi/ castle series

TEMALI OYUN GRUPLARI/
THEMED PLAYGROUNDS



Age / Yaş: 3+
Capacity / Kapasite: 35
Fall height / Max. düşme yüksekliği: 2,0 m
Safety area / Güvenlik alanı: 80,8 m²

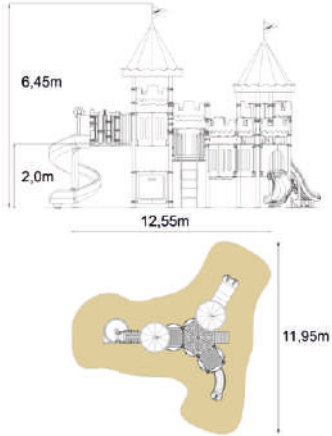

4K 323

Age / Yaş: 3+
Capacity / Kapasite: 110
Fall height / Max. düşme yüksekliği: 2,5 m
Safety area / Güvenlik alanı: 184,9

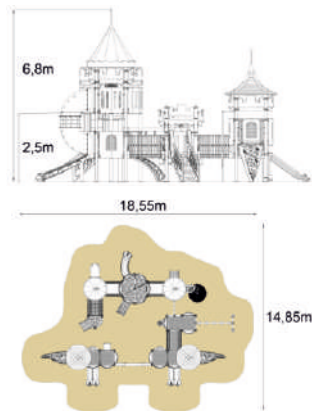

4K 324

1G 320-1



Age / Yaş: 3+
Capacity / Kapasite: 31
Fall height / Max. düşme yüksekliği: 1,5 m
Safety area / Güvenlik alanı: 76,4 m²

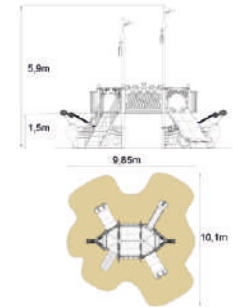

2G 311-1



Age / Yaş: 3+
Capacity / Kapasite: 21
Fall height / Max. düşme yüksekliği: 2,0 m
Safety area / Güvenlik alanı: 76,5 m²

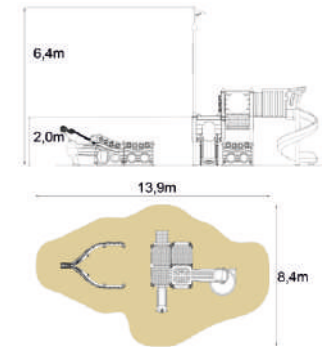

3G 334



Age / Yaş: 3+
Capacity / Kapasite: 17
Fall height / Max. düşme yüksekliği: 2,0 m
Safety area / Güvenlik alanı: 74,7 m²

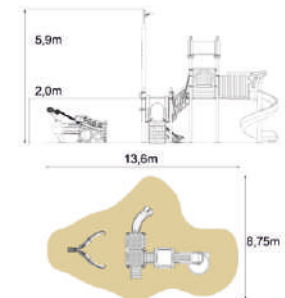

ÇEK CUMHURİYETİ/
CZECH REPUBLIC



gemi serisi/ ship series

TEMALİ OYUN GRUPLARI/
THEMED PLAYGROUNDS

4G 321



Age / Yaş: 3+
Capacity / Kapasite: 56
Fall height / Max. düşme yüksekliği: 2,5 m
Safety area / Güvenlik alanı: 116,9 m²

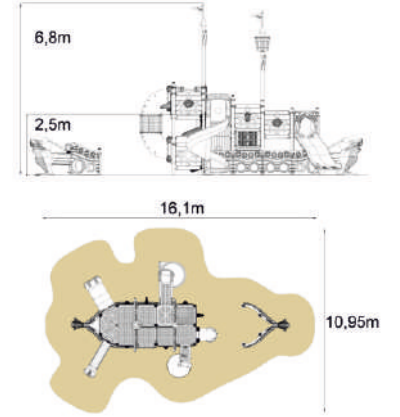

6G 01-1



Age / Yaş: 3+
Capacity / Kapasite: 31
Fall height / Max. düşme yüksekliği: 2,0 m
Safety area / Güvenlik alanı: 119 m²

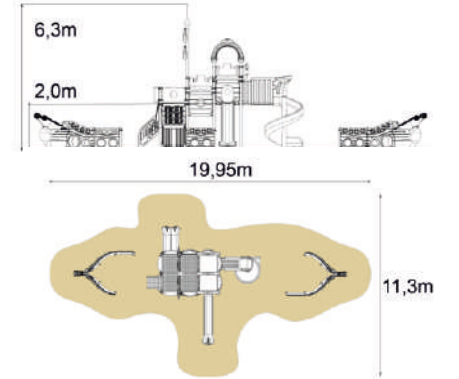



gemi serisi/ ship series

**TEMALI OYUN GRUPLARI/
THEMED PLAYGROUNDS**

RS 01



Age / Yaş: 3+
Capacity / Kapasite: 17
Fall height / Max. düşme yüksekliği: 1,0 m
Safety area / Güvenlik alanı: 63,3 m²

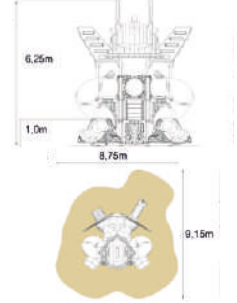

RM 02

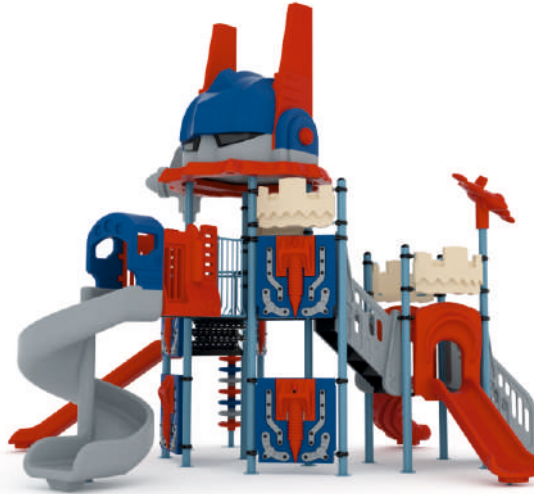

Age / Yaş: 3+
Capacity / Kapasite: 24
Fall height / Max. düşme yüksekliği: 2,0 m
Safety area / Güvenlik alanı: 80,2 m²

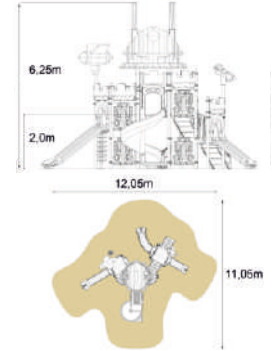

RXL 01



Age / Yaş: 3+
Capacity / Kapasite: 28
Fall height / Max. düşme yüksekliği: 1,0 m
Safety area / Güvenlik alanı: 93,7 m²

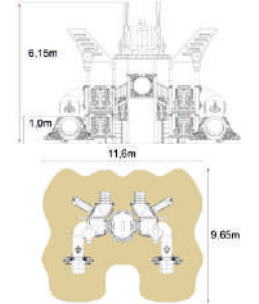



robot serisi/ robot series

TEMALI OYUN GRUPLARI/
THEMED PLAYGROUNDS

RXL 03



Age / Yaş: 3+
Capacity / Kapasite: 35
Fall height / Max. düşme yüksekliği: 2,0 m
Safety area / Güvenlik alanı: 99,5 m²

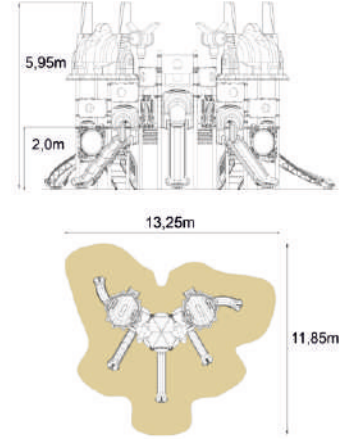

RD 02

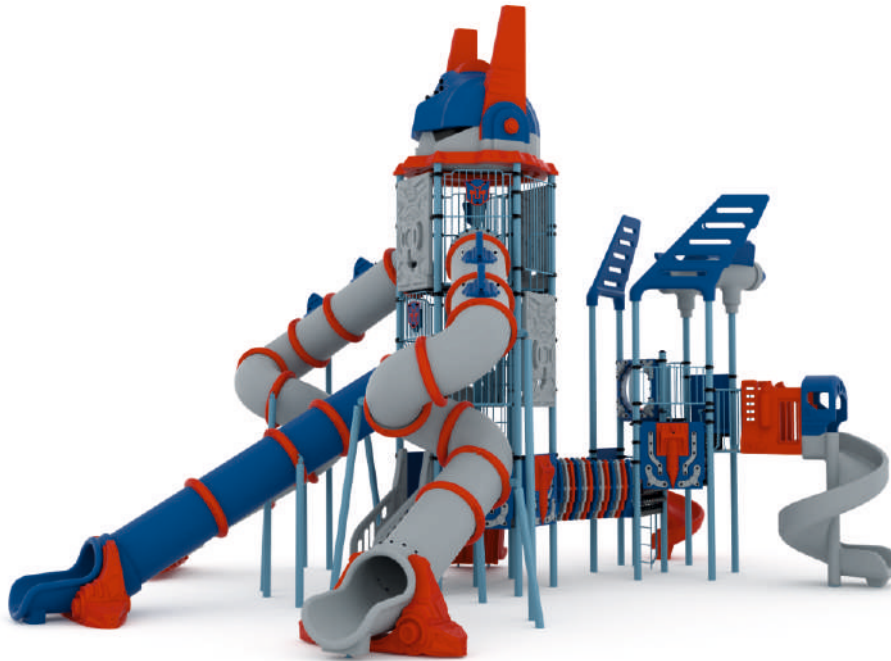

Age / Yaş: 3+
Capacity / Kapasite: 60
Fall height / Max. düşme yüksekliği: 2,5 m
Safety area / Güvenlik alanı: 143 m²

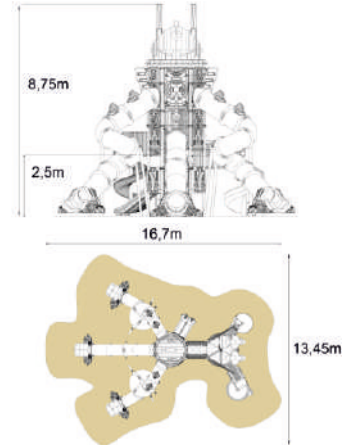



robot serisi/ robot series
TEMALI OYUN GRUPLARI/
THEMED PLAYGROUNDS

CPL 04

**NEW
PRODUCT**



Age / Yaş: 3+
Capacity / Kapasite: 22
Fall height / Max. düşme yüksekliği: 2,5 m
Safety area / Güvenlik alanı: 99,4 m²

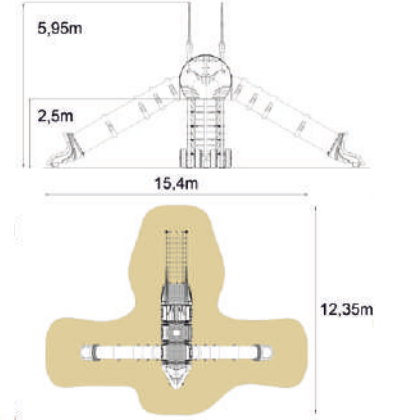

CPL 05

**NEW
PRODUCT**



Age / Yaş: 3+
Capacity / Kapasite: 49
Fall height / Max. düşme yüksekliği: 1,0m
Safety area / Güvenlik alanı: 128,1 m²

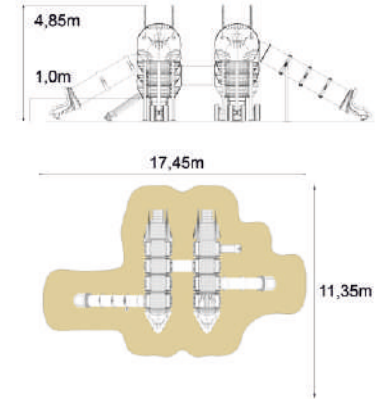

Age / Yaş: 3+
Capacity / Kapasite: 37
Fall height / Max. düşme yüksekliği: 2,5 m
Safety area / Güvenlik alanı: 117,9 m²

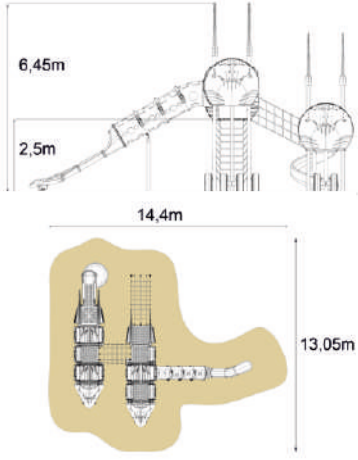

CPL 06

NEW
PRODUCT

uçak serisi/ plane series
TEMALİ OYUN GRUPLARI/
THEMED PLAYGROUNDS

Age / Yaş: 3+
Capacity / Kapasite: 27
Fall height / Max. düşme yüksekliği: 2,0 m
Safety area / Güvenlik alanı: 105,2 m²

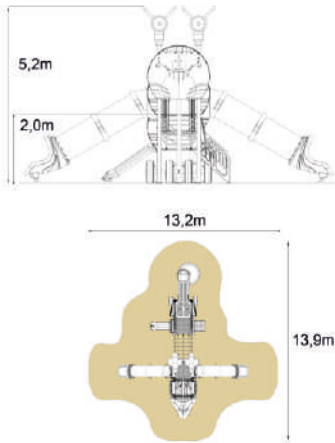

CPL 07

NEW
PRODUCT



Age / Yaş: 3+
Capacity / Kapasite: 25
Fall height / Max. düşme yüksekliği: 1,5 m
Safety area / Güvenlik alanı: 61,7 m²

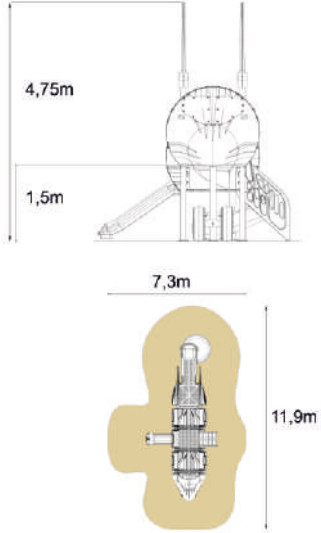

CPL 08

NEW
PRODUCT

uçak serisi/ plane series
TEMALİ OYUN GRUPLARI/
THEMED PLAYGROUNDS

Age / Yaş: 3+
Capacity / Kapasite: 48
Fall height / Max. düşme yüksekliği: 1,5 m
Safety area / Güvenlik alanı: 129,6 m²

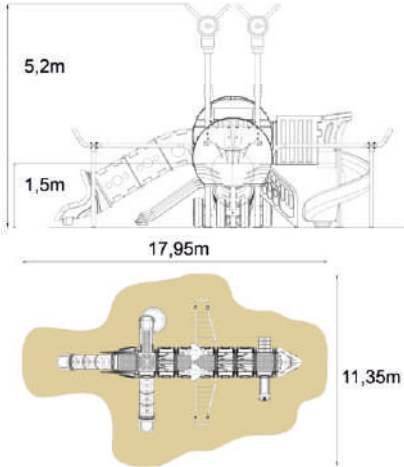

CPL 09

NEW
PRODUCT

TR 09



Age / Yaş: 3+
Capacity / Kapasite: 13
Fall height / Max. düşme yüksekliği: 1,0 m
Safety area / Güvenlik alanı: 50,1 m²

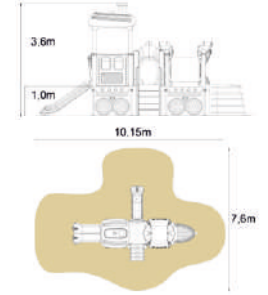

TR 10



Age / Yaş: 3+
Capacity / Kapasite: 29
Fall height / Max. düşme yüksekliği: 1,5 m
Safety area / Güvenlik alanı: 84,1 m²

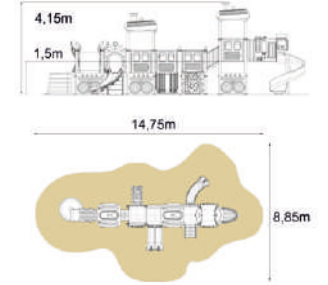

TR 12



Age / Yaş: 3+
Capacity / Kapasite: 20
Fall height / Max. düşme yüksekliği: 1,5 m
Safety area / Güvenlik alanı: 73,7 m²

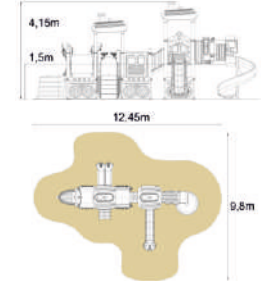

Age / Yaş: 3+
Capacity / Kapasite: 24
Fall height / Max. düşme yüksekliği: 1,5 m
Safety area / Güvenlik alanı: 90,7 m²

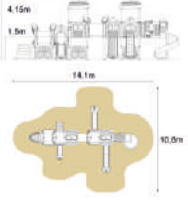

TR 13

Age / Yaş: 3+
Capacity / Kapasite: 33
Fall height / Max. düşme yüksekliği: 2,5 m
Safety area / Güvenlik alanı: 86,6 m²

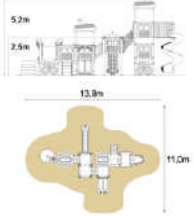

TR 15-1



CXS 01-3



Age / Yaş: 3+
Capacity / Kapasite: 8
Fall height / Max. düşme yüksekliği: 1,25 m
Safety area / Güvenlik alanı: 50,2 m²

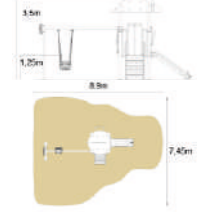

CXS 02-4



Age / Yaş: 3+
Capacity / Kapasite: 11
Fall height / Max. düşme yüksekliği: 1,5 m
Safety area / Güvenlik alanı: 56,2 m²

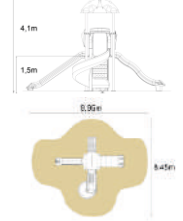

CXS 02-6



Age / Yaş: 3+
Capacity / Kapasite: 10
Fall height / Max. düşme yüksekliği: 1,5 m
Safety area / Güvenlik alanı: 58,3 m²

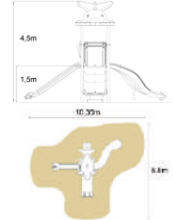

CXS 02-15



Age / Yaş: 3+
Capacity / Kapasite: 11
Fall height / Max. düşme yüksekliği: 1,5 m
Safety area / Güvenlik alanı: 62,6 m²

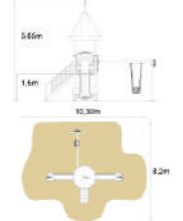



gökkuşuğu serisi/ rainbow series

TEMALI OYUN GRUPLARI/
THEMED PLAYGROUNDS

YUNANISTAN/GREECE



Age / Yaş: 3+
Capacity / Kapasite: 10
Fall height / Max. düşme yüksekliği: 1,5 m
Safety area / Güvenlik alanı: 67,1 m²

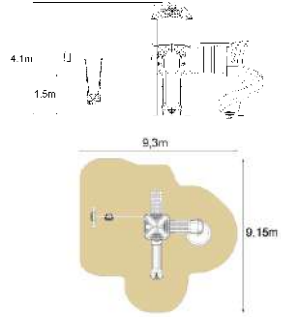

CXS 02-27

Age / Yaş: 3+
Capacity / Kapasite: 22
Fall height / Max. düşme yüksekliği: 1,25 m
Safety area / Güvenlik alanı: 76,9 m²

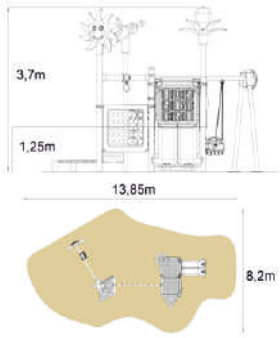

CXS 05-1

Age / Yaş: 3+
Capacity / Kapasite: 8
Fall height / Max. düşme yüksekliği: 1,0 m
Safety area / Güvenlik alanı: 29 m²

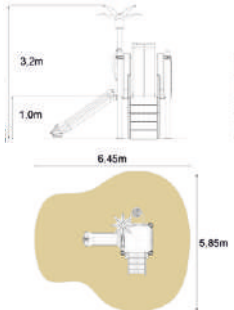

CXS 11

CXS 12



Age / Yaş: 3+
Capacity / Kapasite: 15
Fall height / Max. düşme yüksekliği: 1,5 m
Safety area / Güvenlik alanı: 46,2 m²

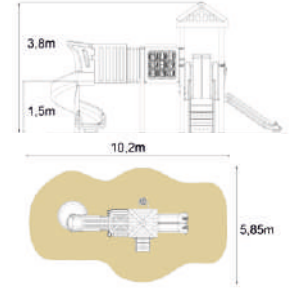

CXS 13



Age / Yaş: 3+
Capacity / Kapasite: 9
Fall height / Max. düşme yüksekliği: 1,5 m
Safety area / Güvenlik alanı: 47,8 m²

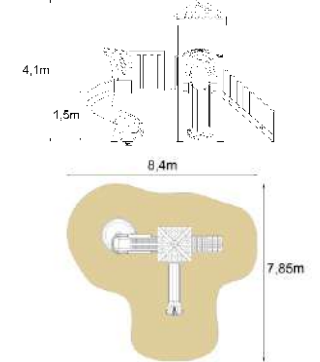

CXS 21-1



Age / Yaş: 3+
Capacity / Kapasite: 17
Fall height / Max. düşme yüksekliği: 2,0 m
Safety area / Güvenlik alanı: 66,7 m²

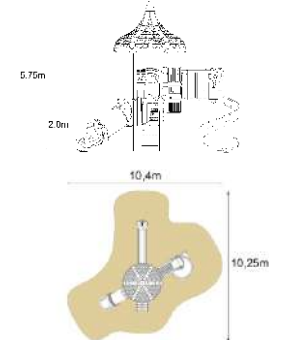



gökkuşuğu serisi /rainbow series

TEMALİ OYUN GRUPLARI/
THEMED PLAYGROUNDS

CS 03-2



Age / Yaş: 3+
Capacity / Kapasite: 19
Fall height / Max. düşme yüksekliği: 2,0 m
Safety area / Güvenlik alanı: 65,8 m²

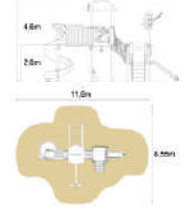

CS 03-13



Age / Yaş: 3+
Capacity / Kapasite: 14
Fall height / Max. düşme yüksekliği: 2,0 m
Safety area / Güvenlik alanı: 64,9 m²

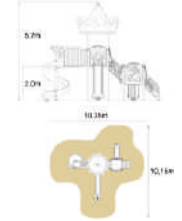

CS 03-26



Age / Yaş: 3+
Capacity / Kapasite: 14
Fall height / Max. düşme yüksekliği: 2,0 m
Safety area / Güvenlik alanı: 67,7 m²

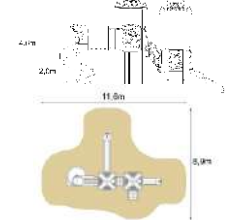

CS 06-5



Age / Yaş: 3+
Capacity / Kapasite: 15
Fall height / Max. düşme yüksekliği: 2,0 m
Safety area / Güvenlik alanı: 61,5 m²

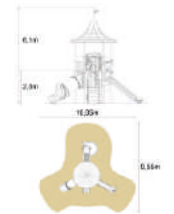



gökkuşuğu serisi / rainbow series

TEMALİ OYUN GRUPLARI/
THEMED PLAYGROUNDS

TEMALI OYUN GRUPLARI/
THEMED PLAYGROUNDS
gökkuşağı serisi/ rainbow series



Age / Yaş: 3+
Capacity / Kapasite: 14
Fall height / Max. düşme yüksekliği: 1,5 m
Safety area / Güvenlik alanı: 71,1 m²

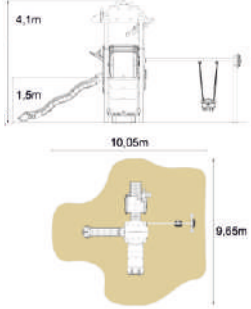

CS 17-14

Age / Yaş: 3+
Capacity / Kapasite: 14
Fall height / Max. düşme yüksekliği: 1,5 m
Safety area / Güvenlik alanı: 68,8 m²

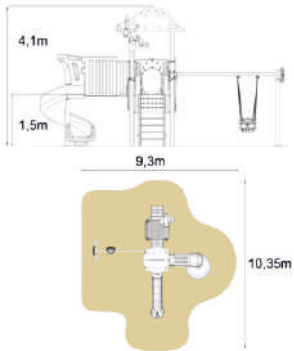

CS 17-15

Age / Yaş: 3+
Capacity / Kapasite: 19
Fall height / Max. düşme yüksekliği: 1,5 m
Safety area / Güvenlik alanı: 84,8 m²

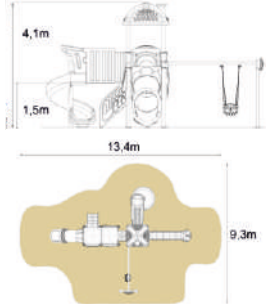

CS 17-17

CS 17-19



Age / Yaş: 3+
Capacity / Kapasite: 14
Fall height / Max. düşme yüksekliği: 1,5 m
Safety area / Güvenlik alanı: 54 m²

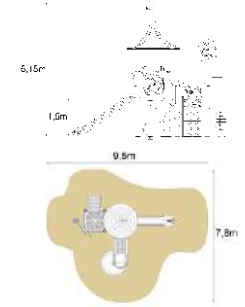

CS 40



Age / Yaş: 3+
Capacity / Kapasite: 14
Fall height / Max. düşme yüksekliği: 1,5 m
Safety area / Güvenlik alanı: 60,3 m²

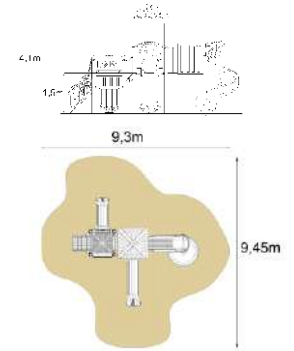

CS 45



Age / Yaş: 3+
Capacity / Kapasite: 27
Fall height / Max. düşme yüksekliği: 2,0 m
Safety area / Güvenlik alanı: 82,1 m²

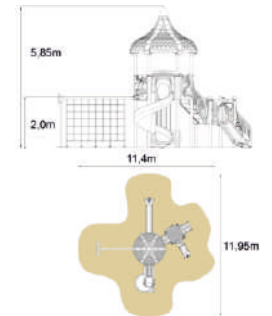

BULGARISTAN/BULGARIA



gökkuşuğu serisi/ rainbow series

TEMALİ OYUN GRUPLARI/
THEMED PLAYGROUNDS



Age / Yaş: 3+
Capacity / Kapasite: 18
Fall height / Max. düşme yüksekliği: 2,0 m
Safety area / Güvenlik alanı: 72,7 m²

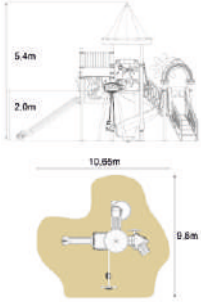

CM 01

Age / Yaş: 3+
Capacity / Kapasite: 21
Fall height / Max. düşme yüksekliği: 2,0 m
Safety area / Güvenlik alanı: 74,1 m²

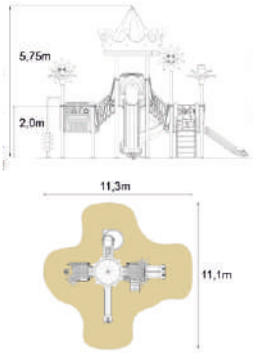

CM 11

Age / Yaş: 3+
Capacity / Kapasite: 25
Fall height / Max. düşme yüksekliği: 2,0 m
Safety area / Güvenlik alanı: 93,5 m²

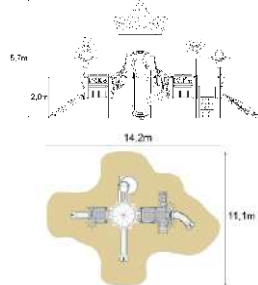

CM 11-9

CM 36



Age / Yaş: 3+
Capacity / Kapasite: 22
Fall height / Max. düşme yüksekliği: 2,0 m
Safety area / Güvenlik alanı: 78,1 m²

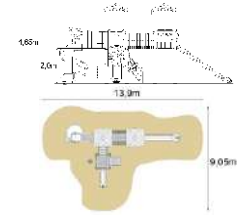

CM 38-1



Age / Yaş: 3+
Capacity / Kapasite: 33
Fall height / Max. düşme yüksekliği: 2,0 m
Safety area / Güvenlik alanı: 88,5 m²

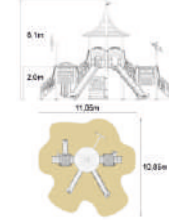

CM 39-1



Age / Yaş: 3+
Capacity / Kapasite: 26
Fall height / Max. düşme yüksekliği: 2,0 m
Safety area / Güvenlik alanı: 67,9 m²

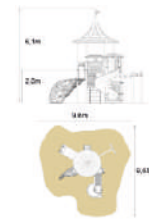

CM 54



Age / Yaş: 3+
Capacity / Kapasite: 24
Fall height / Max. düşme yüksekliği: 2,0 m
Safety area / Güvenlik alanı: 87,7 m²

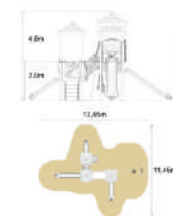



gökkuşağı serisi / rainbow series

TEMALI OYUN GRUPLARI /
THEMED PLAYGROUNDS



Age / Yaş: 3+
Capacity / Kapasite: 40
Fall height / Max. düşme yüksekliği: 2,0 m
Safety area / Güvenlik alanı: 102,9 m²

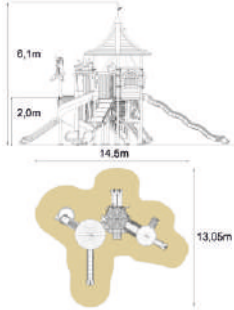

CM 60-1

Age / Yaş: 3+
Capacity / Kapasite: 22
Fall height / Max. düşme yüksekliği: 2,0 m
Safety area / Güvenlik alanı: 77,4 m²

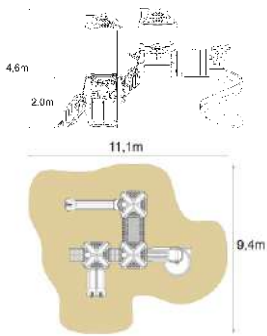

CM 66-1

Age / Yaş: 3+
Capacity / Kapasite: 34
Fall height / Max. düşme yüksekliği: 2,0 m
Safety area / Güvenlik alanı: 94 m²

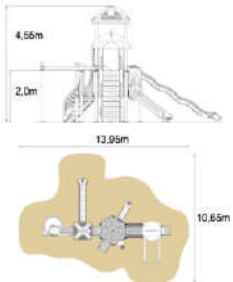

CM 83

CL 01



Age / Yaş: 3+
Capacity / Kapasite: 26
Fall height / Max. düşme yüksekliği: 2,0 m
Safety area / Güvenlik alanı: 99,7 m²

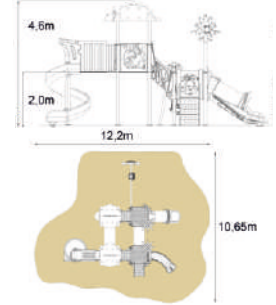

CL 01-9



Age / Yaş: 3+
Capacity / Kapasite: 29
Fall height / Max. düşme yüksekliği: 2,0 m
Safety area / Güvenlik alanı: 107,4 m²

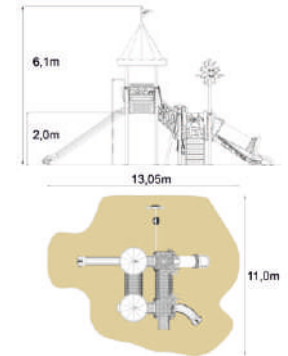

CL 01-11



Age / Yaş: 3+
Capacity / Kapasite: 29
Fall height / Max. düşme yüksekliği: 2,0 m
Safety area / Güvenlik alanı: 79,4 m²

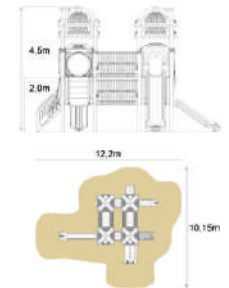

KOLOMBIYA/COLOMBIA



gökuşuğu serisi / rainbow

TEMALİ OYUN GRUPLARI/
THEMED PLAYGROUNDS

CL 02-3



Age / Yaş: 3+
Capacity / Kapasite: 23
Fall height / Max. düşme yüksekliği: 2,0 m
Safety area / Güvenlik alanı: 78,4 m²

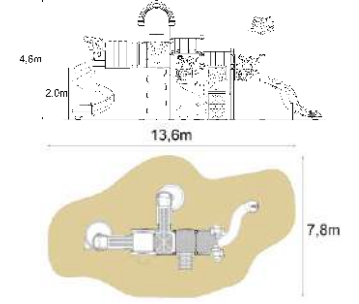

CL 03-1



Age / Yaş: 3+
Capacity / Kapasite: 39
Fall height / Max. düşme yüksekliği: 1,0 m
Safety area / Güvenlik alanı: 104,5 m²

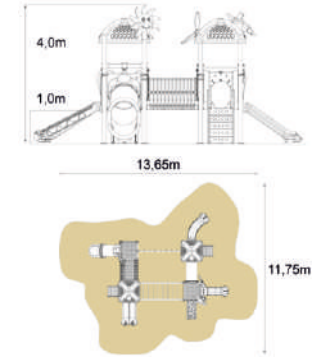

CL 04-1



Age / Yaş: 3+
Capacity / Kapasite: 35
Fall height / Max. düşme yüksekliği: 2,0 m
Safety area / Güvenlik alanı: 89,5 m²

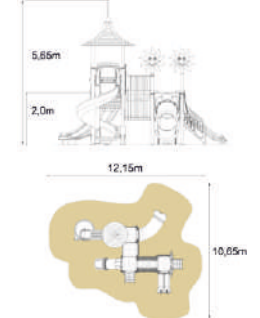



gökkuşağı serisi / rainbow series

TEMALI OYUN GRUPLARI/
THEMED PLAYGROUNDS



CL 24

Age / Yaş: 3+
Capacity / Kapasite: 39
Fall height / Max. düşme yüksekliği: 1,5 m
Safety area / Güvenlik alanı: 84,9 m²

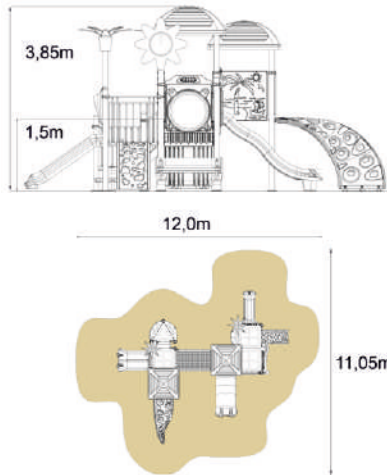

CL 34

Age / Yaş: 3+
Capacity / Kapasite: 34
Fall height / Max. düşme yüksekliği: 2,0 m
Safety area / Güvenlik alanı: 102,7 m²

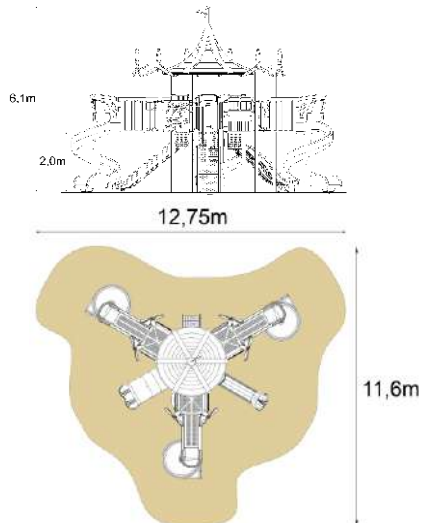

CL 41



Age / Yaş: 3+
Capacity / Kapasite: 26
Fall height / Max. düşme yüksekliği: 2,0 m
Safety area / Güvenlik alanı: 88,7 m²

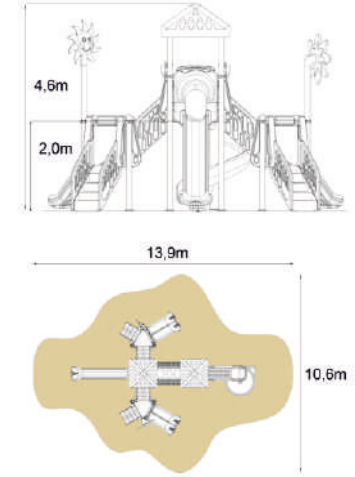

CL 49



Age / Yaş: 3+
Capacity / Kapasite: 20
Fall height / Max. düşme yüksekliği: 2,0 m
Safety area / Güvenlik alanı: 74,6 m²

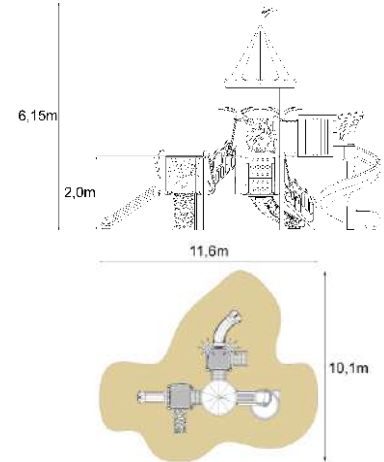

Age / Yaş: 3+
Capacity / Kapasite: 45
Fall height / Max. düşme yüksekliği: 1,5 m
Safety area / Güvenlik alanı: 102,5 m²

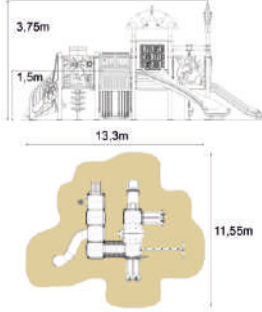

CXL 01-1

Age / Yaş: 3+
Capacity / Kapasite: 38
Fall height / Max. düşme yüksekliği: 1,5 m
Safety area / Güvenlik alanı: 90,1 m²

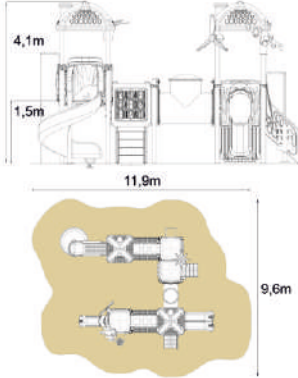

CXL 14

Age / Yaş: 3+
Capacity / Kapasite: 50
Fall height / Max. düşme yüksekliği: 2,5 m
Safety area / Güvenlik alanı: 108,8 m²

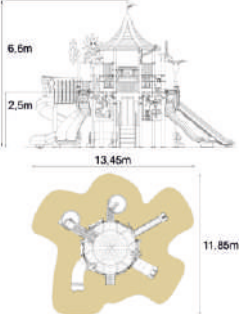

CXL 15

CXL 15-5



Age / Yaş: 3+
Capacity / Kapasite: 49
Fall height / Max. düşme yüksekliği: 2,0 m
Safety area / Güvenlik alanı: 111,3 m²

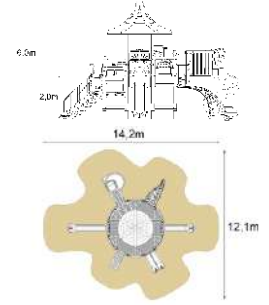

CXL 18-1



Age / Yaş: 3+
Capacity / Kapasite: 54
Fall height / Max. düşme yüksekliği: 2,0 m
Safety area / Güvenlik alanı: 134,5 m²

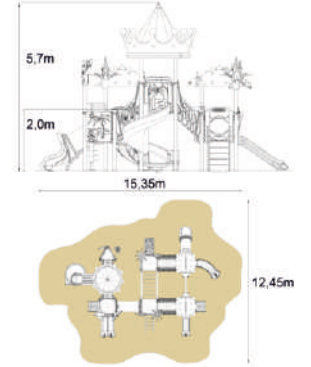

CXL 27



Age / Yaş: 3+
Capacity / Kapasite: 37
Fall height / Max. düşme yüksekliği: 1,5 m
Safety area / Güvenlik alanı: 99

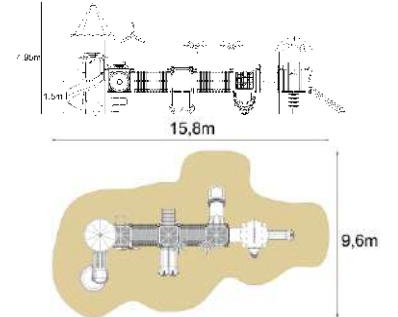



gökkuşak series / rainbow series

TEMALI OYUN GRUPLARI/
THEMED PLAYGROUNDS

CXL 37



Age / Yaş: 3+
Capacity / Kapasite: 49
Fall height / Max. düşme yüksekliği: 2,0 m
Safety area / Güvenlik alanı: 136,1 m²

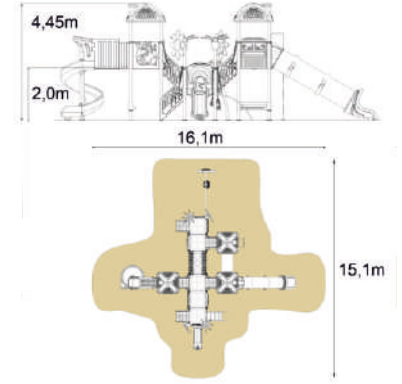

CXL 39-1



Age / Yaş: 3+
Capacity / Kapasite: 36
Fall height / Max. düşme yüksekliği: 2,0 m
Safety area / Güvenlik alanı: 118,9 m²

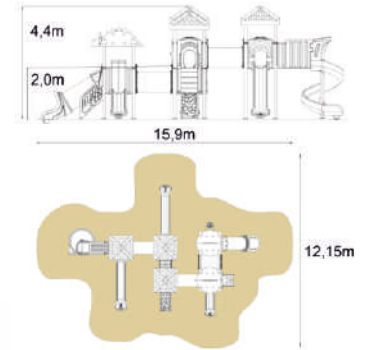



gökkuşağı serisi/ rainbow serjies

TEMALİ OYUN GRUPLARI/
THEMED PLAYGROUNDS

CXL 43



Age / Yaş: 3+
Capacity / Kapasite: 44
Fall height / Max. düşme yüksekliği: 2,0 m
Safety area / Güvenlik alanı: 101,2 m²

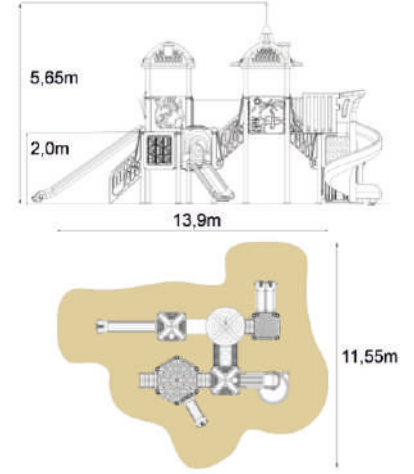

CXL 45



Age / Yaş: 3+
Capacity / Kapasite: 85
Fall height / Max. düşme yüksekliği: 2,0 m
Safety area / Güvenlik alanı: 191,4 m²

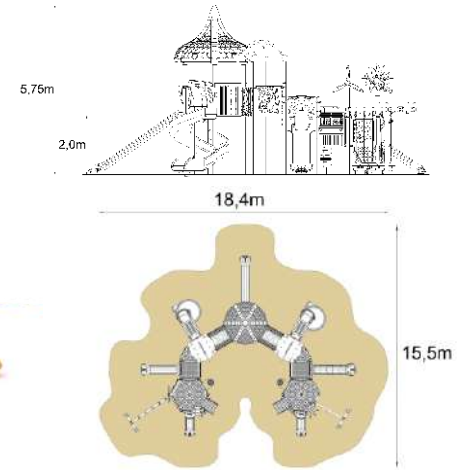



gökuşuğı serisi/ rainbow series

TEMALI OYUN GRUPLARI/
THEMED PLAYGROUNDS

CD 04-1



Age / Yaş: 3+
Capacity / Kapasite: 253
Fall height / Max. düşme yüksekliği: 2,5 m
Safety area / Güvenlik alanı: 437,2 m²

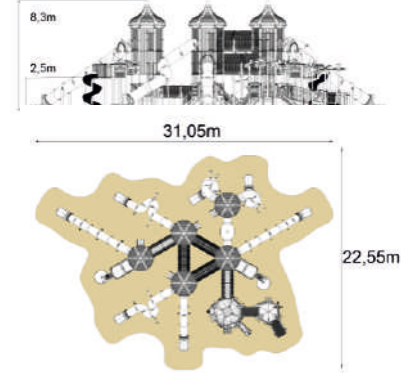

CD 30



Age / Yaş: 3+
Capacity / Kapasite: 221
Fall height / Max. düşme yüksekliği: 2,5 m
Safety area / Güvenlik alanı: 359,7 m²

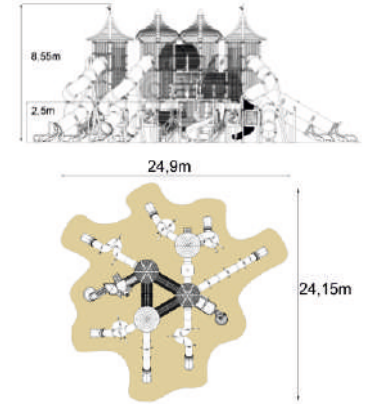



gökkuşuğu serisi / rainbow series

TEMALİ OYUN GRUPLARI/
THEMED PLAYGROUNDS



Age / Yaş: 3+
Capacity / Kapasite: 59
Fall height / Max. düşme yüksekliği: 2,0 m
Safety area / Güvenlik alanı: 111,6 m²

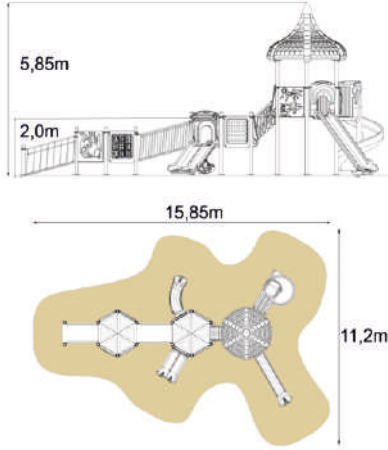

CE 04

Age / Yaş: 3+
Capacity / Kapasite: 42
Fall height / Max. düşme yüksekliği: 1,0 m
Safety area / Güvenlik alanı: 69,9 m²

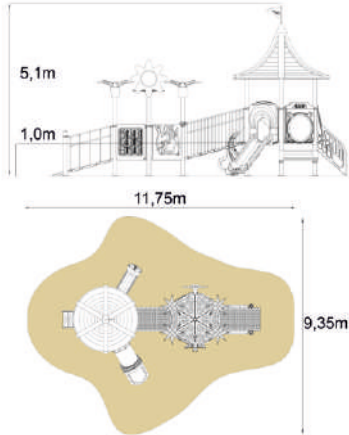

CE 11-2

EKOXS 01-2



Age / Yaş: 3+
Capacity / Kapasite: 6
Fall height / Max. düşme yüksekliği: 1,25 m
Safety area / Güvenlik alanı: 48 m²

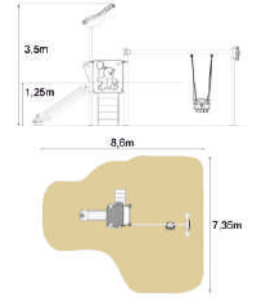

EKOXS 02



Age / Yaş: 3+
Capacity / Kapasite: 6
Fall height / Max. düşme yüksekliği: 1,5 m
Safety area / Güvenlik alanı: 31,9 m²

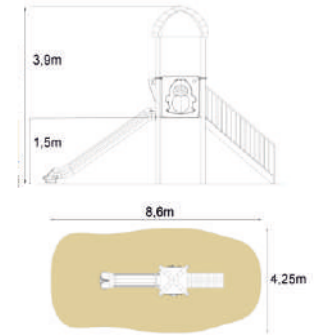

EKOS 04



Age / Yaş: 3+
Capacity / Kapasite: 11
Fall height / Max. düşme yüksekliği: 1,0 m
Safety area / Güvenlik alanı: 46,9 m²

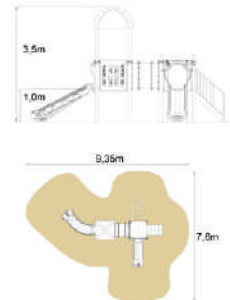

Age / Yaş: 3+
Capacity / Kapasite: 10
Fall height / Max. düşme yüksekliği: 1,0 m
Safety area / Güvenlik alanı: 39,2 m²

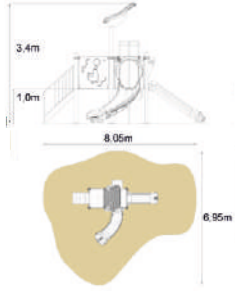

EKOS 05-1

Age / Yaş: 3+
Capacity / Kapasite: 18
Fall height / Max. düşme yüksekliği: 1,5 m
Safety area / Güvenlik alanı: 65,8 m²

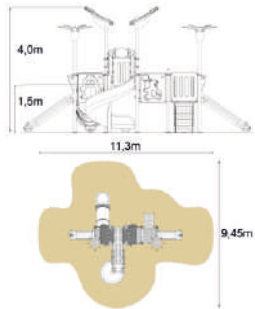

EKOM 02-5

Age / Yaş: 3+
Capacity / Kapasite: 16
Fall height / Max. düşme yüksekliği: 1,5 m
Safety area / Güvenlik alanı: 64,4 m²

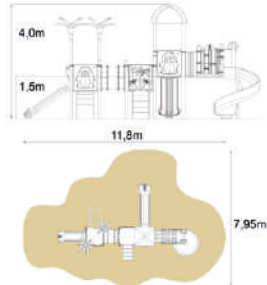

EKOM 13



EKOL 02

Age / Yaş: 3+
Capacity / Kapasite: 17
Fall height / Max. düşme yüksekliği: 2,0 m
Safety area / Güvenlik alanı: 68,3 m²

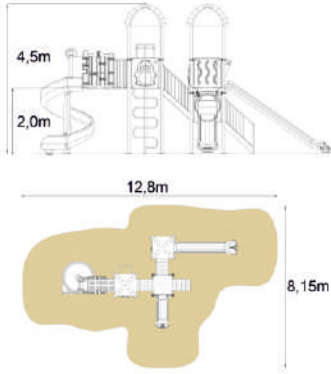

EKOL 03

Age / Yaş: 3+
Capacity / Kapasite: 18
Fall height / Max. düşme yüksekliği: 2,0 m
Safety area / Güvenlik alanı: 74,3 m²

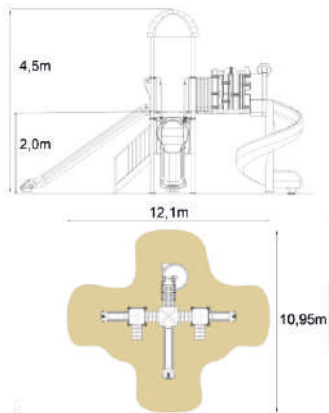

EKOXL 01



Age / Yaş: 3+
Capacity / Kapasite: 27
Fall height / Max. düşme yüksekliği: 2,0 m
Safety area / Güvenlik alanı: 98,8 m²

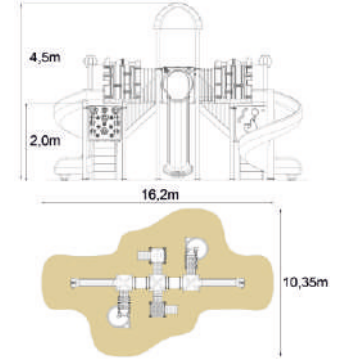

EKOXL 03



Age / Yaş: 3+
Capacity / Kapasite: 30
Fall height / Max. düşme yüksekliği: 2,0 m
Safety area / Güvenlik alanı: 136,4 m²

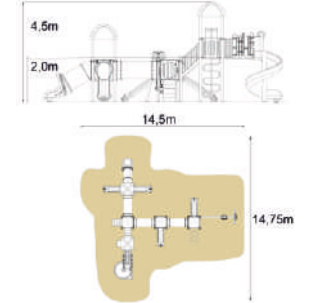



gökkuşagi serisi / rainbow series

TEMALI OYUN GRUPLARI/
THEMED PLAYGROUNDS

**İÇ MEKAN
OYUN GRUPLARI
INDOOR
PLAYGROUNDS**

MSL 01



Age / Yaş: 3+
Capacity / Kapasite: 3
Fall height / Max. düşme yüksekliği: 1,1 m
Safety area / Güvenlik alanı: 38,5 m²

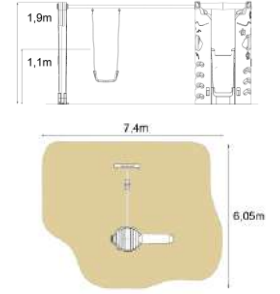

MSL 02



Age / Yaş: 3+
Capacity / Kapasite: 2
Fall height / Max. düşme yüksekliği: 1,0 m
Safety area / Güvenlik alanı: 20,3 m²

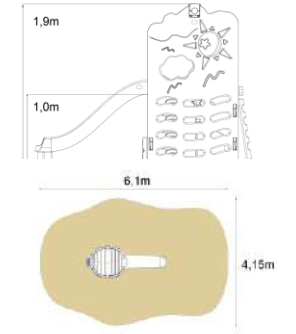

MSL 03



Age / Yaş: 3+
Capacity / Kapasite: 6
Fall height / Max. düşme yüksekliği: 0,6 m
Safety area / Güvenlik alanı: 29,6 m²

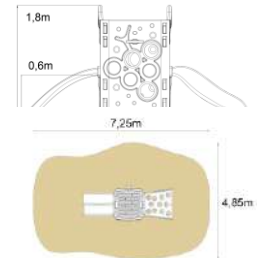

MSL 04

Age / Yaş: 3+
Capacity / Kapasite: 5
Fall height / Max. düşme yüksekliği: 0,6 m
Safety area / Güvenlik alanı: 19,8 m²

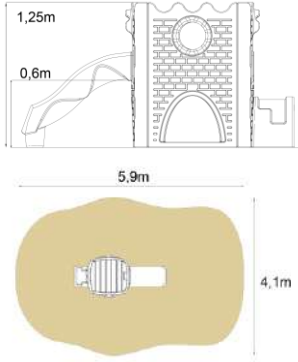

MSL 06

Age / Yaş: 3+
Capacity / Kapasite: 10
Fall height / Max. düşme yüksekliği: 0,6 m
Safety area / Güvenlik alanı: 26,6 m²

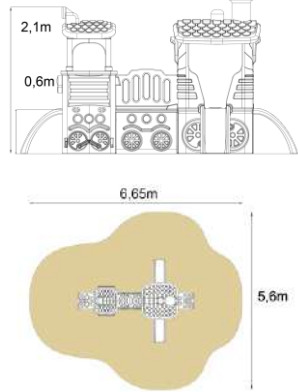

MSL 07



Age / Yaş: 3+
Capacity / Kapasite: 7
Fall height / Max. düşme yüksekliği: 0,6 m
Safety area / Güvenlik alanı: 21,2 m²

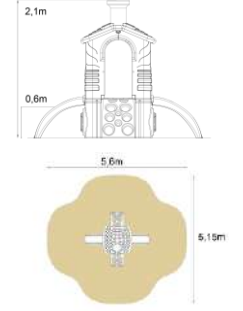

MSL 08



Age / Yaş: 3+
Capacity / Kapasite: 10
Fall height / Max. düşme yüksekliği: 1,0 m
Safety area / Güvenlik alanı: 28 m²

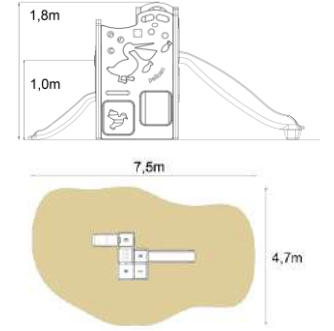

MSL 101



Age / Yaş: 3+
Capacity / Kapasite: 1
Fall height / Max. düşme yüksekliği: 0,25 m

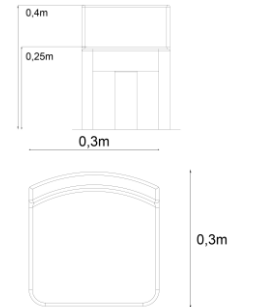

Age / Yaş: 3+
Capacity / Kapasite: 2
Fall height / Max. düşme yüksekliği: 0,65 m
Safety area / Güvenlik alanı: 8,0 m²

MSL 102

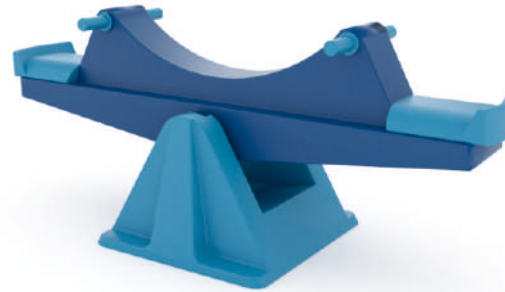
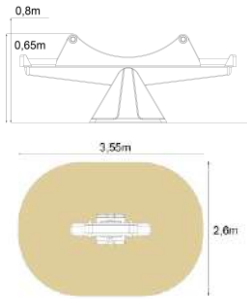

Age / Yaş: 3+
Capacity / Kapasite: 1
Fall height / Max. düşme yüksekliği: 0,25 m

MSL 103

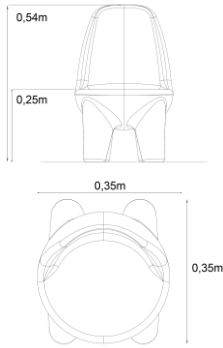

Age / Yaş: 3+
Fall height / Max. düşme yüksekliği: 0,37 m

MSL 104

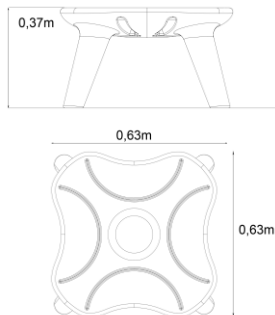

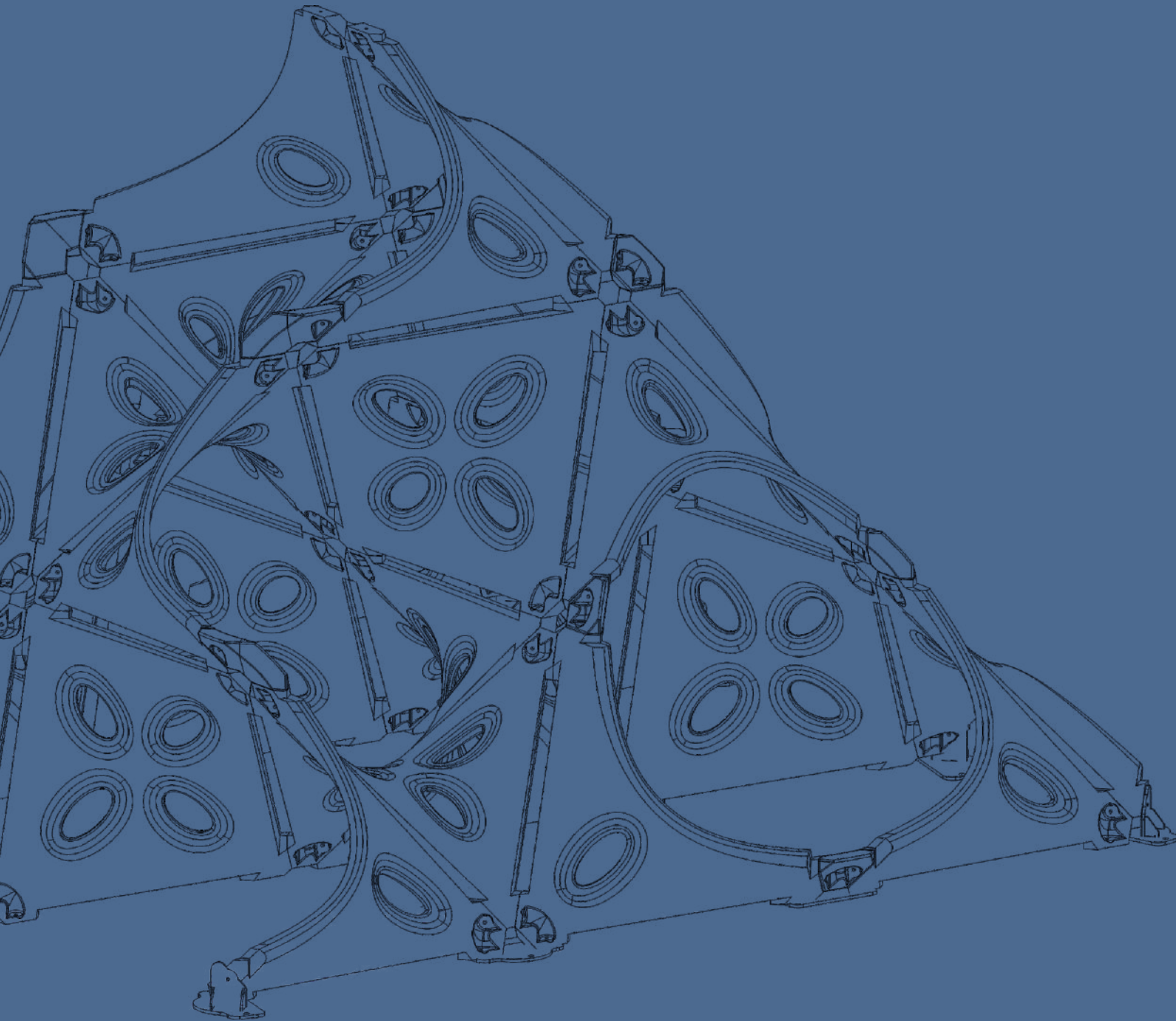

MODÜLER TIRMANMA MODULER CLIMBING

92	DELTOİK TIRMANMA	DELTOIK CLIMBING	92
100	LUNA TIRMANMA	LUNA CLIMBING	100
101	ASTERO TIRMANMA	ASTERO CLIMBING	101
105	DENGE TIRMANMA	BALANCE CLIMBING	105
112	BURGU TIRMANMA	GIMLET CLIMBING	112
116	DUVAR TIRMANMA	BOULDERING	116
124	SILVER SERİSİ	SILVER SERIES	124

CA 1607



Age / Yaş: 3+
Capacity / Kapasite: 21
Fall height / Max. düşme yüksekliği: 1,1 m
Safety area / Güvenlik alanı: 36,3 m²

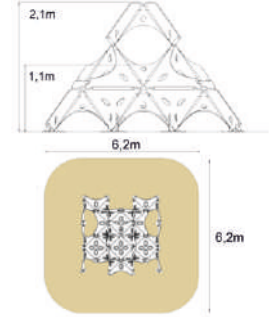

CA 1609



Age / Yaş: 3+
Capacity / Kapasite: 16
Fall height / Max. düşme yüksekliği: 1,4 m
Safety area / Güvenlik alanı: 30 m²

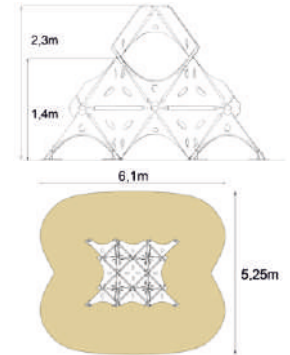

CA 1611



Age / Yaş: 3+
Capacity / Kapasite: 12
Fall height / Max. düşme yüksekliği: 1,4 m
Safety area / Güvenlik alanı: 29,5 m²

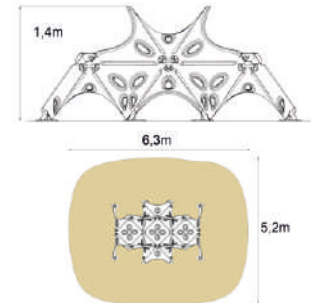

LITVANYA/LITHUANIA



детский тирманма / dettsok climbing

MODÜLER TIRMANMA/
MODULAR CLIMBING

MODÜLER TIRMANMA/
MODULAR CLIMBING

deltoik tirmanma/ deltoik climbing

İNGİLTERE/ENGLAND



İNGİLTERE/ENGLAND



BELÇİKA/BELGIUM



AMERİKA/USA



PANAMA/PANAMA



BOSNA HERSEK/BOSNIA and HERCEGOVINA



deltoik tirmanma/ deltoik climbing

MODÜLER TIRMANMA/
MODULAR CLIMBING

SLOVAKYA/SLOVAKIA



Age / Yaş: 3+
Capacity / Kapasite: 22
Fall height / Max. düşme yüksekliği: 1,1 m
Safety area / Güvenlik alanı: 42,7 m²

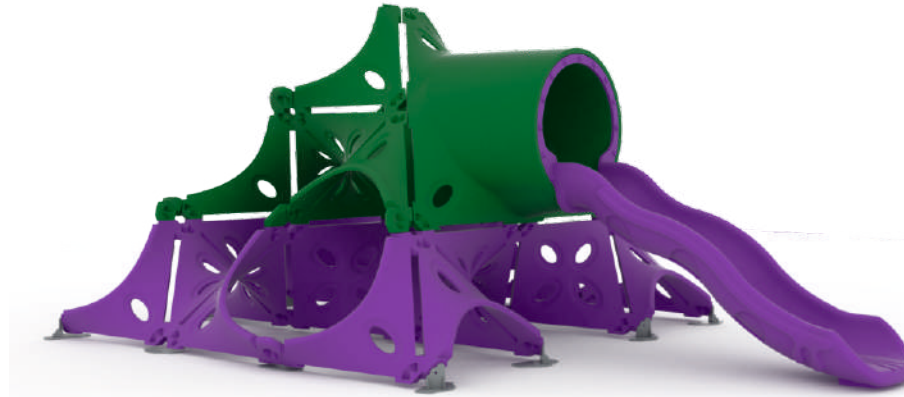
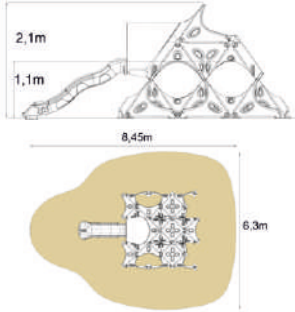

CA 1614

Age / Yaş: 3+
Capacity / Kapasite: 39
Fall height / Max. düşme yüksekliği: 1,1 m
Safety area / Güvenlik alanı: 65,7 m²

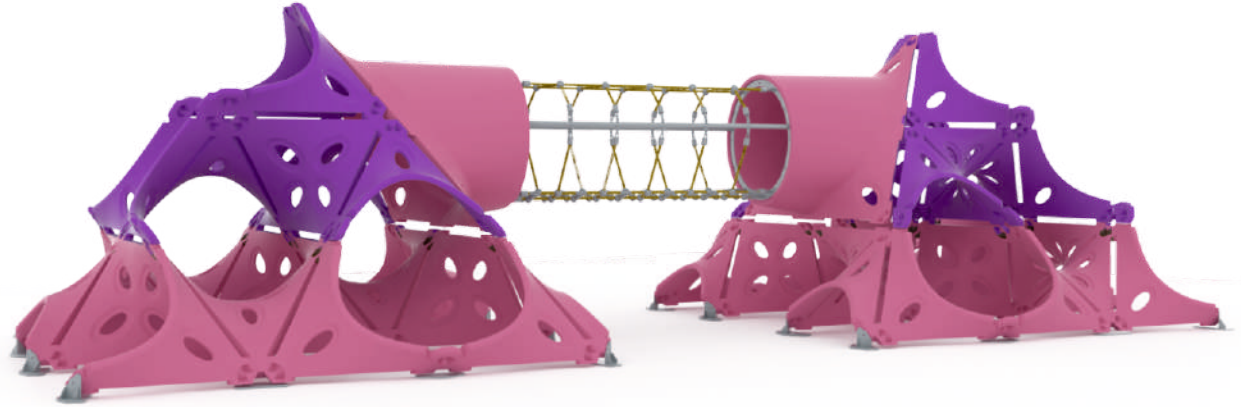
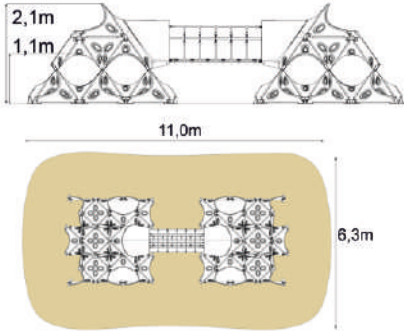

CA 1615

Age / Yaş: 3+
Capacity / Kapasite: 86
Fall height / Max. düşme yüksekliği: 1,1 m
Safety area / Güvenlik alanı: 105,7 m²

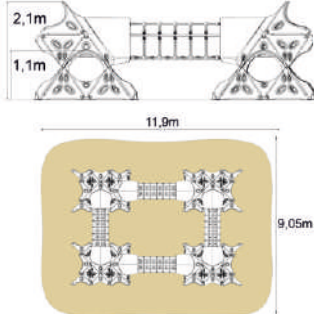

CA 1616

CA 1619



Age / Yaş: 5+
Capacity / Kapasite: 29
Fall height / Max. düşme yüksekliği: 1,7 m
Safety area / Güvenlik alanı: 81,5 m²

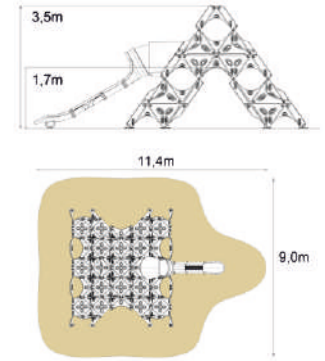

CA 1620

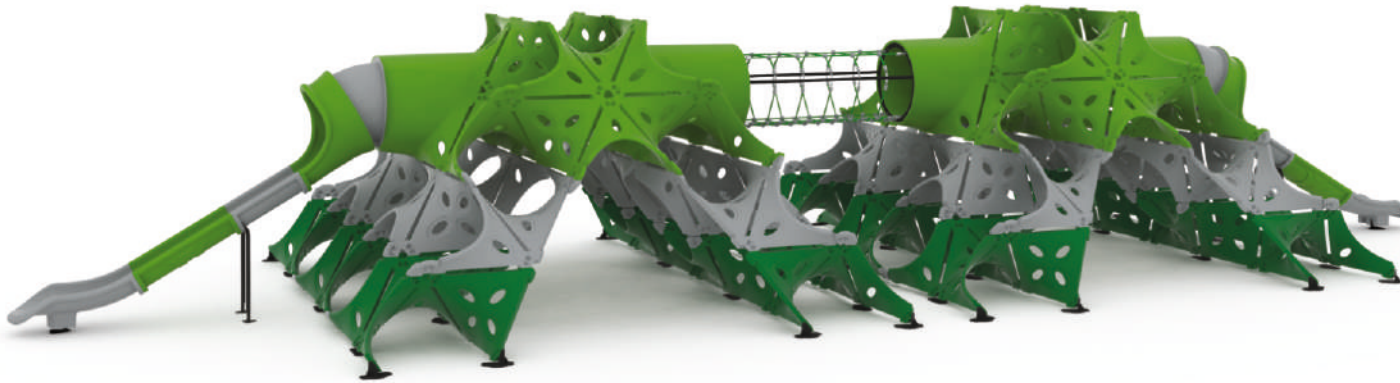

Age / Yaş: 5+
Capacity / Kapasite: 97
Fall height / Max. düşme yüksekliği: 1,7 m
Safety area / Güvenlik alanı: 142,1 m²

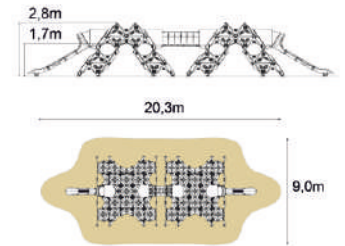



deltoik tirmanma/ deltoik climbing

**MODÜLER TIRMANMA/
MODULAR CLIMBING**

CA 1701
NEW
PRODUCT



Age / Yaş: 3+
Capacity / Kapasite: 7
Fall height / Max. düşme yüksekliği: 1,7 m
Safety area / Güvenlik alanı: 45,2 m²

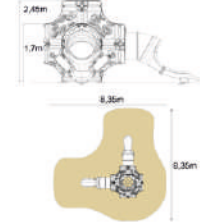

CA 1707
NEW
PRODUCT



Age / Yaş: 3+
Capacity / Kapasite: 15
Fall height / Max. düşme yüksekliği: 1,7 m
Safety area / Güvenlik alanı: 41 m²

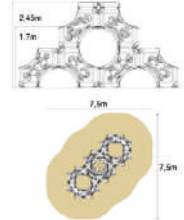

CA 1709
NEW
PRODUCT



Age / Yaş: 3+
Capacity / Kapasite: 13
Fall height / Max. düşme yüksekliği: 1,7 m
Safety area / Güvenlik alanı: 52 m²

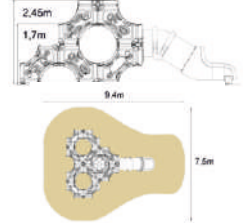

CA 1713
NEW
PRODUCT



Age / Yaş: 3+
Capacity / Kapasite: 22
Fall height / Max. düşme yüksekliği: 1,7 m
Safety area / Güvenlik alanı: 102,4 m²

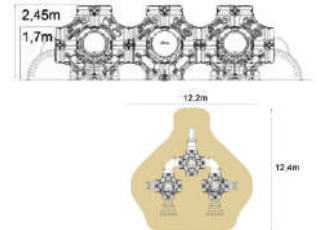

Age / Yaş: 5+
Capacity / Kapasite: 2
Fall height / Max. düşme yüksekliği: 1,35 m
Safety area / Güvenlik alanı: 14,35 m²

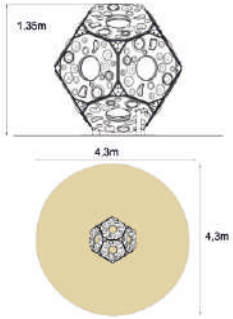

DGHS 101
**NEW
PRODUCT**

astero tırmanma/ astero climbing
**MODÜLER TIRMANMA/
MODULAR CLIMBING**

Age / Yaş: 5+
Capacity / Kapasite: 4
Fall height / Max. düşme yüksekliği: 2,35 m
Safety area / Güvenlik alanı: 18,8 m²

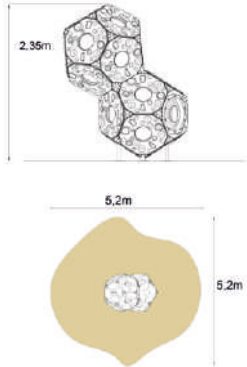

DGHS 102
**NEW
PRODUCT**

Age / Yaş: 5+
Capacity / Kapasite: 6
Fall height / Max. düşme yüksekliği: 2,35 m
Safety area / Güvenlik alanı: 23,6 m²

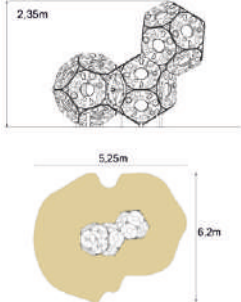

DGHS 103
**NEW
PRODUCT**

DGHS 104
NEW
PRODUCT



Age / Yaş: 5+
Capacity / Kapasite: 8
Fall height / Max. düşme yüksekliği: 2,35 m
Safety area / Güvenlik alanı: 28,3 m²

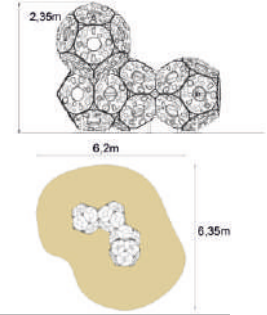

DGHS 105
NEW
PRODUCT



Age / Yaş: 5+
Capacity / Kapasite: 14
Fall height / Max. düşme yüksekliği: 2,35 m
Safety area / Güvenlik alanı: 36,2 m²

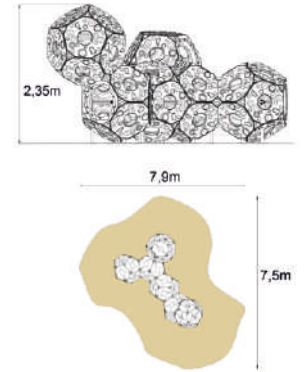

DGHS 106
NEW
PRODUCT



Age / Yaş: 5+
Capacity / Kapasite: 6
Fall height / Max. düşme yüksekliği: 1,35 m
Safety area / Güvenlik alanı: 23,2 m²

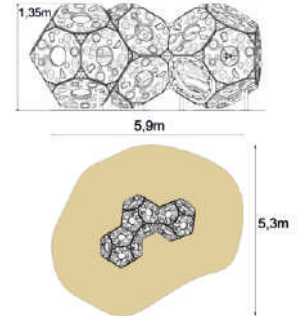

Age / Yaş: 5+
Capacity / Kapasite: 8
Fall height / Max. düşme yüksekliği: 1,35 m
Safety area / Güvenlik alanı: 28,1 m²

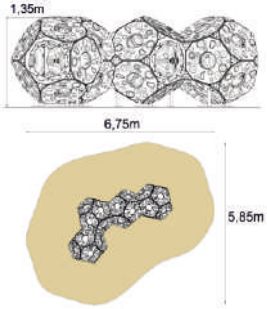

DGHS 107
**NEW
PRODUCT**

astero tırmanma/ astero climbing
**MODÜLER TIRMANMA/
MODULAR CLIMBING**

Age / Yaş: 5+
Capacity / Kapasite: 8
Fall height / Max. düşme yüksekliği: 2,35 m
Safety area / Güvenlik alanı: 27,5 m²

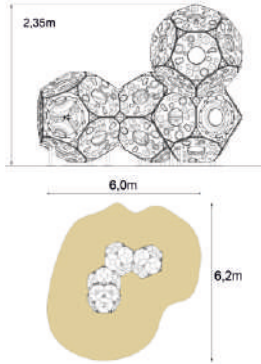

DGHS 108
**NEW
PRODUCT**

Age / Yaş: 5+
Capacity / Kapasite: 10
Fall height / Max. düşme yüksekliği: 2,35 m
Safety area / Güvenlik alanı: 33,6 m²

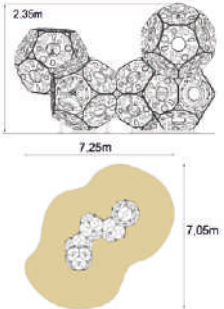

DGHS 109
**NEW
PRODUCT**

DGHS 110
NEW
PRODUCT



Age / Yaş: 5+
Capacity / Kapasite: 14
Fall height / Max. düşme yüksekliği: 1,9 m
Safety area / Güvenlik alanı: 48,7 m²

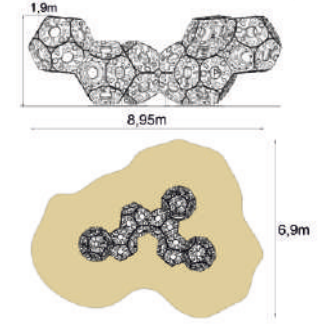

DGHS 111
NEW
PRODUCT

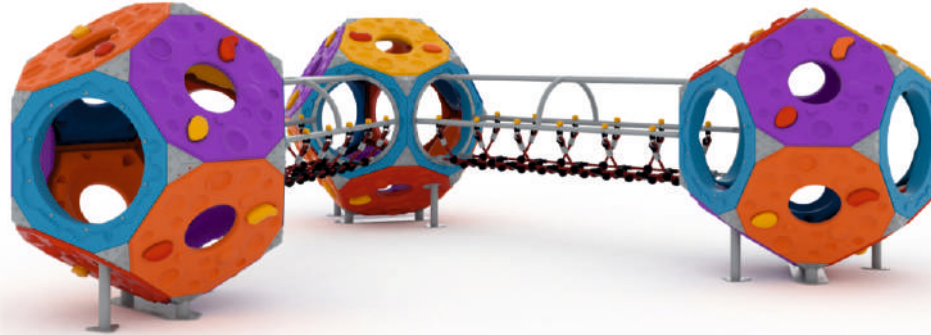

Age / Yaş: 5+
Capacity / Kapasite: 10
Fall height / Max. düşme yüksekliği: 1,35 m
Safety area / Güvenlik alanı: 35 m²

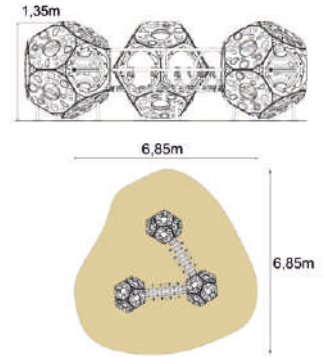

DGHS 112
NEW
PRODUCT



Age / Yaş: 5+
Capacity / Kapasite: 1
Fall height / Max. düşme yüksekliği: 2,35 m
Safety area / Güvenlik alanı: 34,2 m²

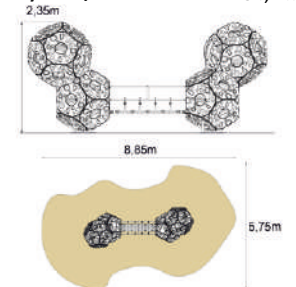

Age / Yaş: 3+
 Capacity / Kapasite: 6
 Fall height / Max. düşme yüksekliği: 0,8 m
 Safety area / Güvenlik alanı: 20 m²

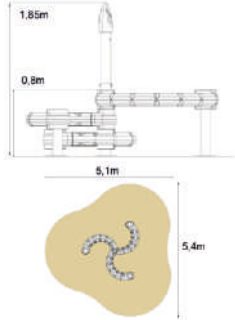

CA 1800
**NEW
 PRODUCT**

denge tırmanma/ balance climbing
**MODÜLER TIRMANMA/
 MODULAR CLIMBING**

Age / Yaş: 3+
 Capacity / Kapasite: 12
 Fall height / Max. düşme yüksekliği: 0,8 m
 Safety area / Güvenlik alanı: 31,8 m²

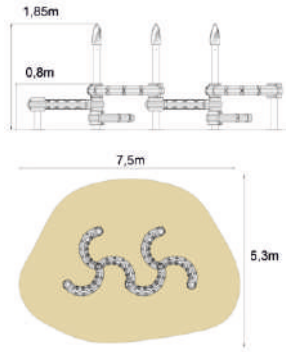

CA 1801
**NEW
 PRODUCT**

Age / Yaş: 3+
 Capacity / Kapasite: 20
 Fall height / Max. düşme yüksekliği: 0,8 m
 Safety area / Güvenlik alanı: 41,6 m²

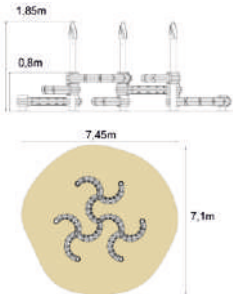

CA 1802
**NEW
 PRODUCT**

CA 1803
**NEW
PRODUCT**



Age / Yaş: 3+
Capacity / Kapasite: 52
Fall height / Max. düşme yüksekliği: 0,8 m
Safety area / Güvenlik alanı: 137,1 m²

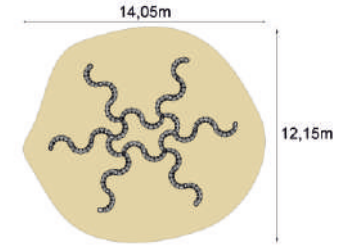
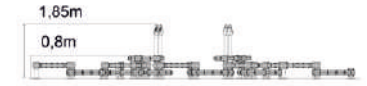

CA 1804
**NEW
PRODUCT**



Age / Yaş: 3+
Capacity / Kapasite: 56
Fall height / Max. düşme yüksekliği: 0,8 m
Safety area / Güvenlik alanı: 100,5 m²

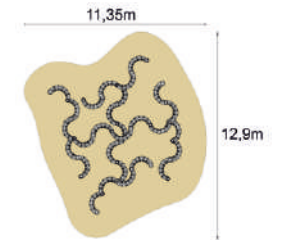



denge tırmanma / balance climbing

**MODÜLER TIRMANMA /
MODULAR CLIMBING**

CA 1850
**NEW
PRODUCT**

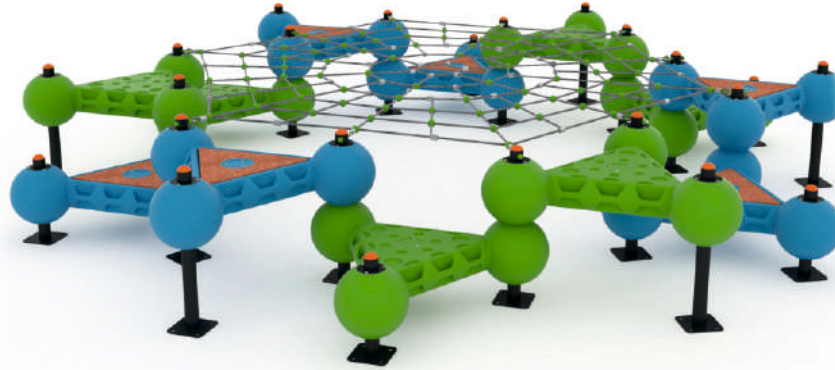

Age / Yaş: 5+
Capacity / Kapasite: 33
Fall height / Max. düşme yüksekliği: 1,0 m
Safety area / Güvenlik alanı: 73,4 m²

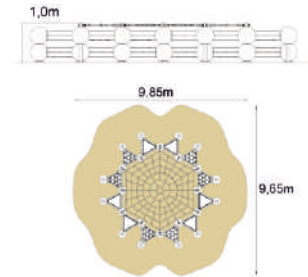

CA 1851
**NEW
PRODUCT**

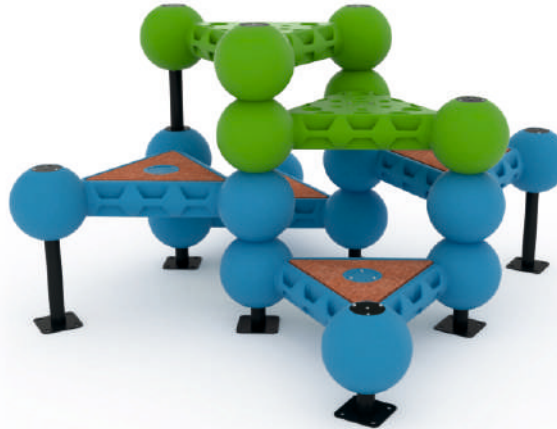

Age / Yaş: 5+
Capacity / Kapasite: 8
Fall height / Max. düşme yüksekliği: 1,75 m
Safety area / Güvenlik alanı: 31,4 m²

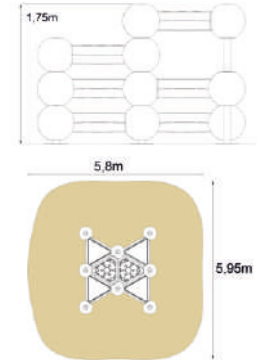

CA 1852
**NEW
PRODUCT**



Age / Yaş: 5+
Capacity / Kapasite: 14
Fall height / Max. düşme yüksekliği: 2,6 m
Safety area / Güvenlik alanı: 40 m²

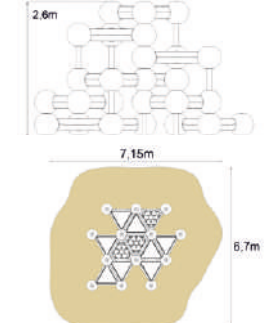

Age / Yaş: 5+
Capacity / Kapasite: 11
Fall height / Max. düşme yüksekliği: 1,75 m
Safety area / Güvenlik alanı: 54,5 m²

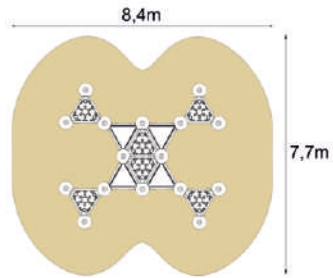
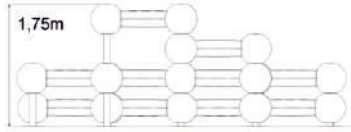

CA 1853
**NEW
PRODUCT**

denge tırmanma/ balance climbing
**MODÜLER TIRMANMA/
MODULAR CLIMBING**

Age / Yaş: 5+
Capacity / Kapasite: 16
Fall height / Max. düşme yüksekliği: 1,0 m
Safety area / Güvenlik alanı: 54 m²

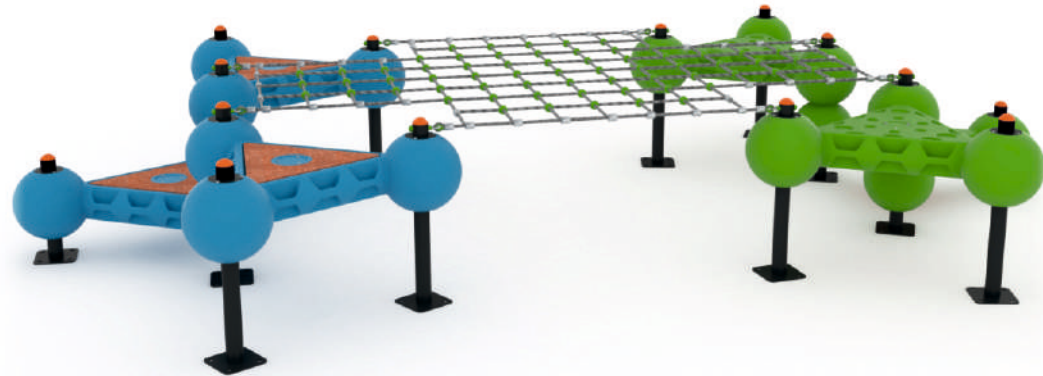
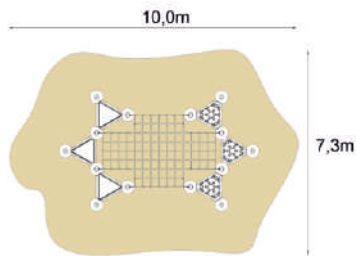

CA 1854
**NEW
PRODUCT**

MODÜLER TIRMANMA/
MODULAR CLIMBING

denge tirmanma/ balance climbing



Age / Yaş: 5+
Capacity / Kapasite: 7
Fall height / Max. düşme yüksekliği: 2,6 m
Safety area / Güvenlik alanı: 34,6 m²

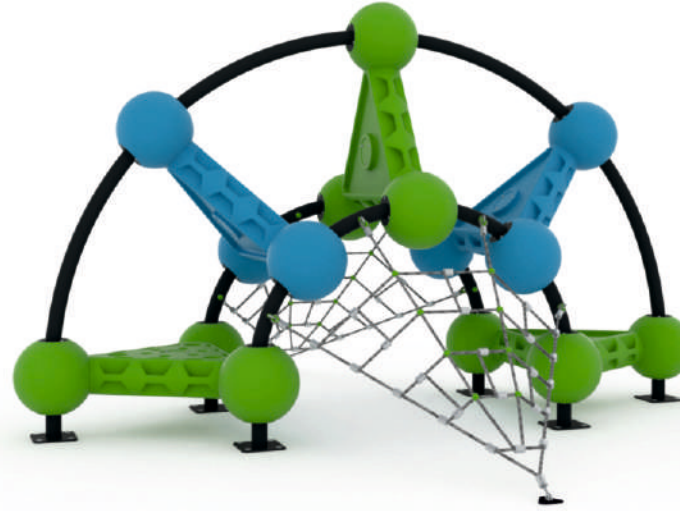
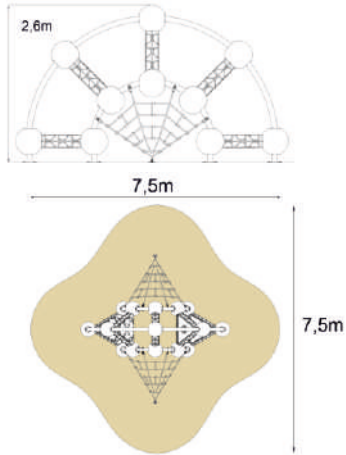

CA 1855
**NEW
PRODUCT**

denge tırmanma/ balance climbing
MODÜLER TIRMANMA/
MODULAR CLIMBING

Age / Yaş: 5+
Capacity / Kapasite: 13
Fall height / Max. düşme yüksekliği: 2,6 m
Safety area / Güvenlik alanı: 66,5 m²

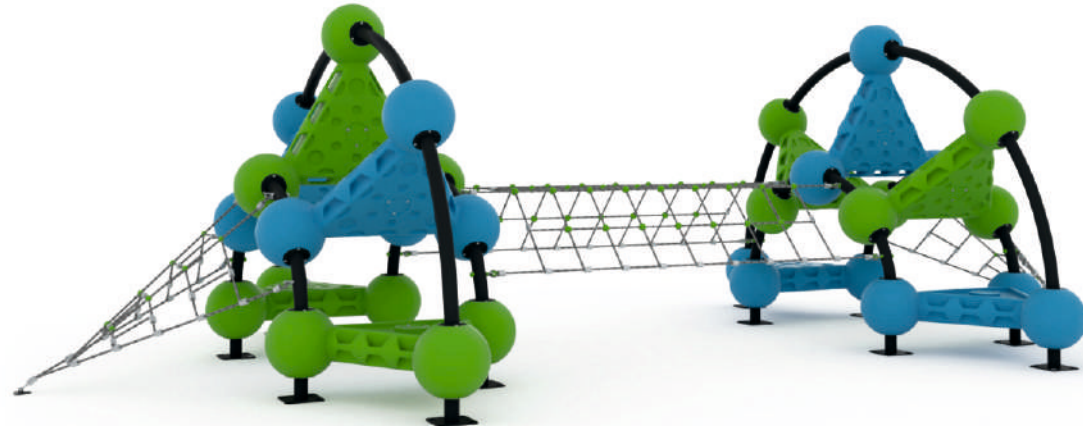
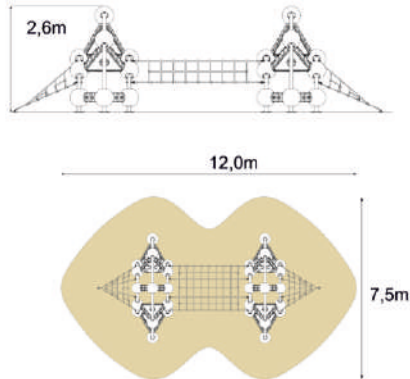

CA 1856
**NEW
PRODUCT**

CA 810
NEW
PRODUCT



Age / Yaş: 3+
Capacity / Kapasite: 8
Fall height / Max. düşme yüksekliği: 1,15 m
Safety area / Güvenlik alanı: 41 m²

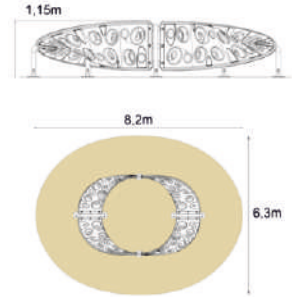

CA 811
NEW
PRODUCT



Age / Yaş: 3+
Capacity / Kapasite: 19
Fall height / Max. düşme yüksekliği: 2,1 m
Safety area / Güvenlik alanı: 63,4 m²

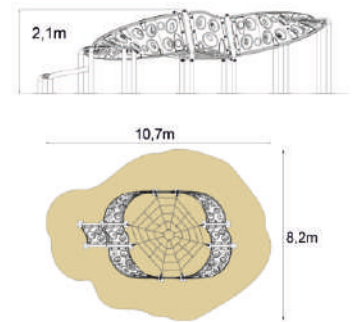

CA 812
NEW
PRODUCT



Age / Yaş: 3+
Capacity / Kapasite: 14
Fall height / Max. düşme yüksekliği: 2,1 m
Safety area / Güvenlik alanı: 63,4 m²

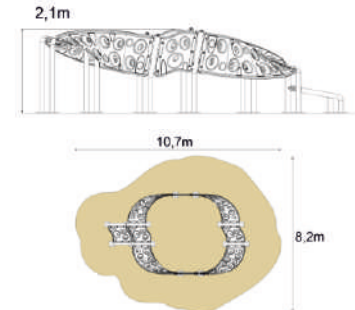



burgu tirmama, gimlet climbing

MODÜLER TIRMANMA/
MODULAR CLIMBING

CA 813
NEW
PRODUCT



Age / Yaş: 3+
Capacity / Kapasite: 4
Fall height / Max. düşme yüksekliği: 2,4 m
Safety area / Güvenlik alanı: 23,8 m²

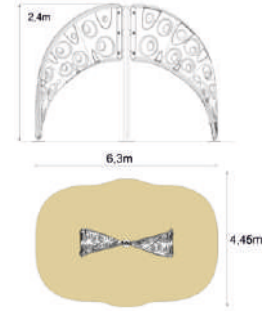

CA 814
NEW
PRODUCT



Age / Yaş: 3+
Capacity / Kapasite: 6
Fall height / Max. düşme yüksekliği: 2,4 m
Safety area / Güvenlik alanı: 28,2 m²

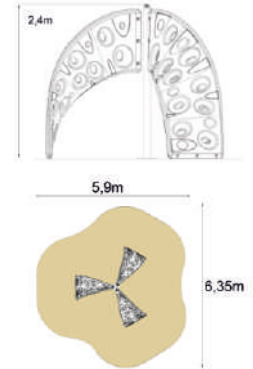

CA 815
NEW
PRODUCT



Age / Yaş: 3+
Capacity / Kapasite: 8
Fall height / Max. düşme yüksekliği: 2,4 m
Safety area / Güvenlik alanı: 30,4 m²

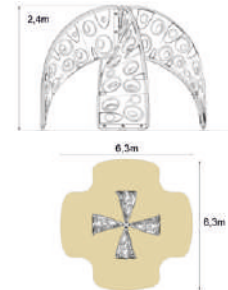

Age / Yaş: 3+
 Capacity / Kapasite: 6
 Fall height / Max. düşme yüksekliği: 2,45 m
 Safety area / Güvenlik alanı: 31,2 m²

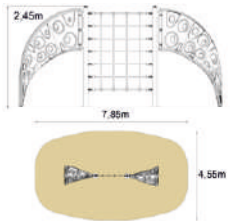

CA 816
**NEW
 PRODUCT**

Age / Yaş: 3+
 Capacity / Kapasite: 12
 Fall height / Max. düşme yüksekliği: 2,45 m
 Safety area / Güvenlik alanı: 48 m²

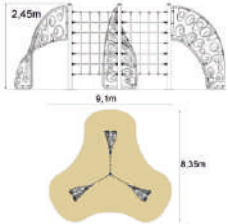

CA 817
**NEW
 PRODUCT**

Age / Yaş: 3+
 Capacity / Kapasite: 10
 Fall height / Max. düşme yüksekliği: 2,45 m
 Safety area / Güvenlik alanı: 58,8 m²

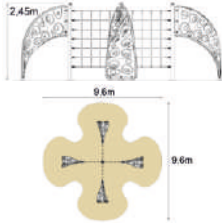

CA 818
**NEW
 PRODUCT**

Age / Yaş: 3+
 Capacity / Kapasite: 12
 Fall height / Max. düşme yüksekliği: 2,4 m
 Safety area / Güvenlik alanı: 72,8 m²

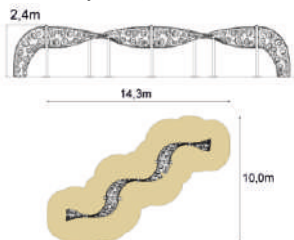

CA 819
**NEW
 PRODUCT**

CA 918
NEW
PRODUCT



Age / Yaş: 3+
Capacity / Kapasite: 8
Fall height / Max. düşme yüksekliği: 2,2 m
Safety area / Güvenlik alanı: 33,7 m²

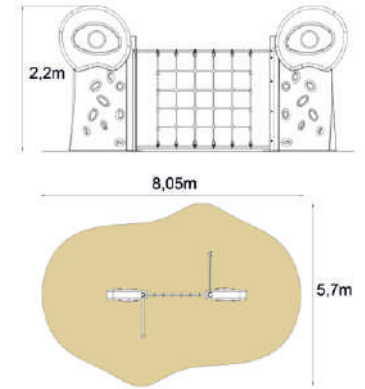

CA 919
NEW
PRODUCT



Age / Yaş: 3+
Capacity / Kapasite: 6
Fall height / Max. düşme yüksekliği: 2,2 m
Safety area / Güvenlik alanı: 33,7 m²

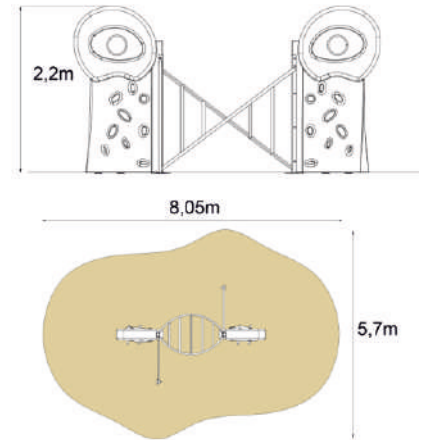



duvar tırmanma / bouldering

**MODÜLER TIRMANMA/
MODULAR CLIMBING**

CA 921
**NEW
PRODUCT**



Age / Yaş: 3+
Capacity / Kapasite: 15
Fall height / Max. düşme yüksekliği: 2,75 m
Safety area / Güvenlik alanı: 80,9 m²

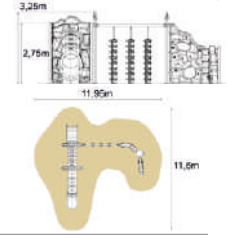

CA 922
**NEW
PRODUCT**



Age / Yaş: 3+
Capacity / Kapasite: 21
Fall height / Max. düşme yüksekliği: 2,7 m
Safety area / Güvenlik alanı: 109,1 m²

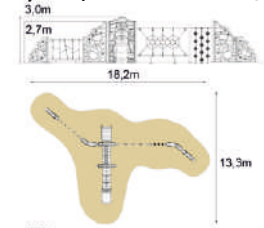

CA 923
**NEW
PRODUCT**



Age / Yaş: 3+
Capacity / Kapasite: 10
Fall height / Max. düşme yüksekliği: 2,7 m
Safety area / Güvenlik alanı: 58,7 m²

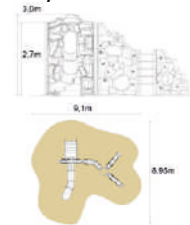

CA 924
**NEW
PRODUCT**

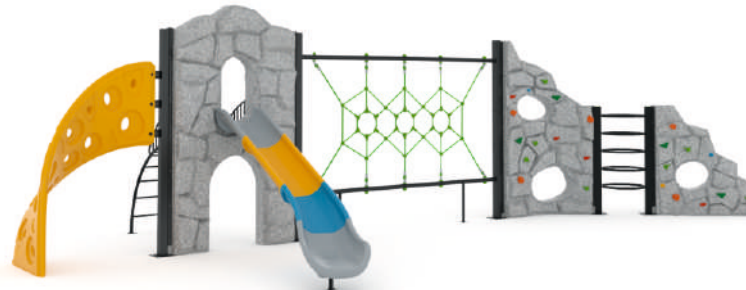

Age / Yaş: 3+
Capacity / Kapasite: 14
Fall height / Max. düşme yüksekliği: 2,7 m
Safety area / Güvenlik alanı: 73,3 m²

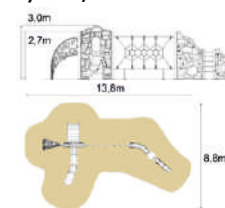

Age / Yaş: 3+
 Capacity / Kapasite: 23
 Fall height / Max. düşme yüksekliği: 2,7 m
 Safety area / Güvenlik alanı: 101,8 m²

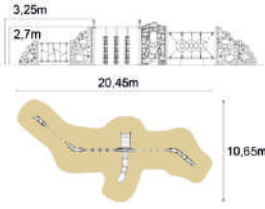

CA 925
**NEW
 PRODUCT**

Age / Yaş: 3+
 Capacity / Kapasite: 13
 Fall height / Max. düşme yüksekliği: 2,7 m
 Safety area / Güvenlik alanı: 78,8 m²

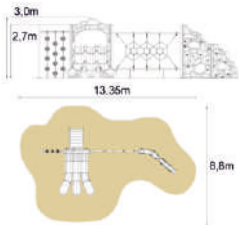

CA 926
**NEW
 PRODUCT**

Age / Yaş: 3+
 Capacity / Kapasite: 21
 Fall height / Max. düşme yüksekliği: 2,7 m
 Safety area / Güvenlik alanı: 80,5 m²

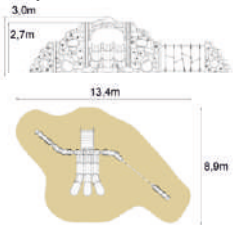

CA 927
**NEW
 PRODUCT**

Age / Yaş: 3+
 Capacity / Kapasite: 30
 Fall height / Max. düşme yüksekliği: 2,7 m
 Safety area / Güvenlik alanı: 153 m²

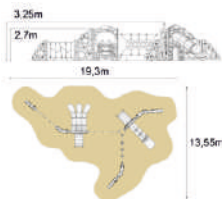

CA 928
**NEW
 PRODUCT**

CA 929
NEW
PRODUCT



Age / Yaş: 3+
Capacity / Kapasite: 14
Fall height / Max. düşme yüksekliği: 2,7 m
Safety area / Güvenlik alanı: 75 m²

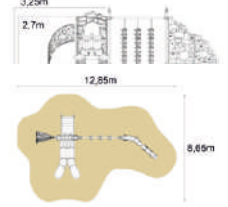

CA 930
NEW
PRODUCT



Age / Yaş: 3+
Capacity / Kapasite: 24
Fall height / Max. düşme yüksekliği: 2,7 m
Safety area / Güvenlik alanı: 89,2 m²

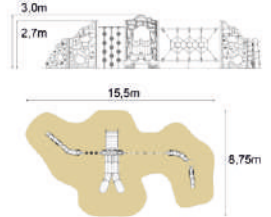



duvar tırmanma/ bouldering
**MODÜLER TIRMANMA/
MODULAR CLIMBING**

CA 931
**NEW
PRODUCT**



Age / Yaş: 3+
Capacity / Kapasite: 26
Fall height / Max. düşme yüksekliği: 2,7 m
Safety area / Güvenlik alanı: 111,4 m²

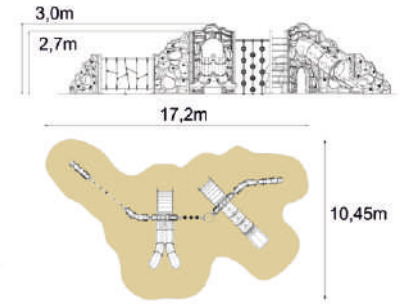

CA 932
**NEW
PRODUCT**



Age / Yaş: 3+
Capacity / Kapasite: 18
Fall height / Max. düşme yüksekliği: 2,7 m
Safety area / Güvenlik alanı: 94 m²

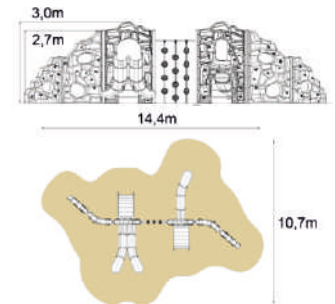

CA 933
**NEW
PRODUCT**



Age / Yaş: 3+
Capacity / Kapasite: 13
Fall height / Max. düşme yüksekliği: 1,7 m
Safety area / Güvenlik alanı: 26,3 m²

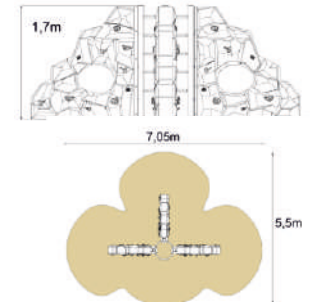

Age / Yaş: 3+
 Capacity / Kapasite: 17
 Fall height / Max. düşme yüksekliği: 1,7 m
 Safety area / Güvenlik alanı: 30 m²

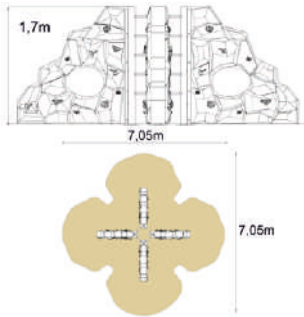

CA 934
**NEW
 PRODUCT**

duvar tırmanma/ bouldering
**MODÜLER TIRMANMA/
 MODULAR CLIMBING**

Age / Yaş: 3+
 Capacity / Kapasite: 15
 Fall height / Max. düşme yüksekliği: 2,7 m
 Safety area / Güvenlik alanı: 48,1 m²

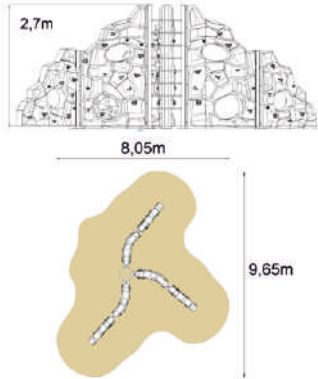

CA 935
**NEW
 PRODUCT**

Age / Yaş: 3+
 Capacity / Kapasite: 25
 Fall height / Max. düşme yüksekliği: 2,7 m
 Safety area / Güvenlik alanı: 56,3 m²

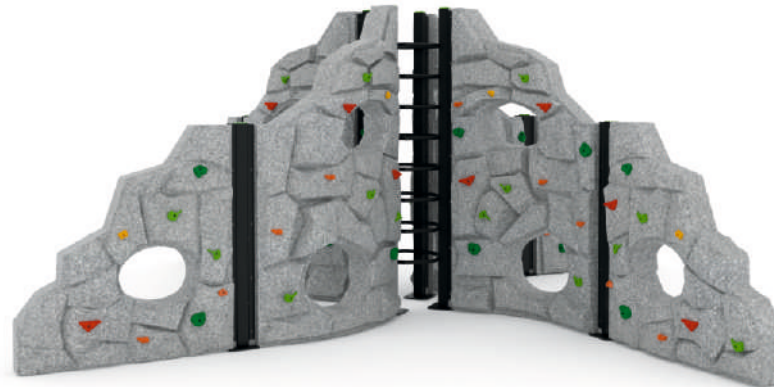
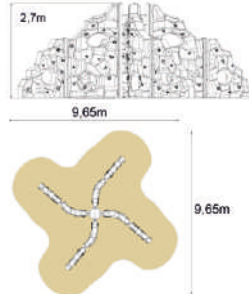

CA 936
**NEW
 PRODUCT**

DGSS 201

NEW
PRODUCT



Age / Yaş: 7+
Capacity / Kapasite: 22
Fall height / Max. düşme yüksekliği: 2,0 m
Safety area / Güvenlik alanı: 62,7 m²

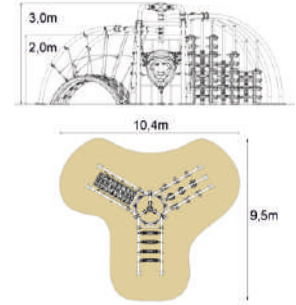

DGSS 206

NEW
PRODUCT



Age / Yaş: 7+
Capacity / Kapasite: 33
Fall height / Max. düşme yüksekliği: 2,2 m
Safety area / Güvenlik alanı: 85,4 m²

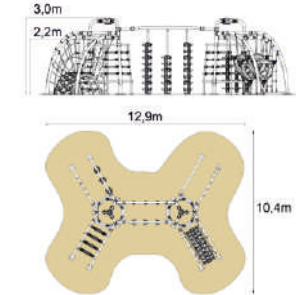



silver series/ silver series
**MODÜLER TIRMANMA/
MODULAR CLIMBING**

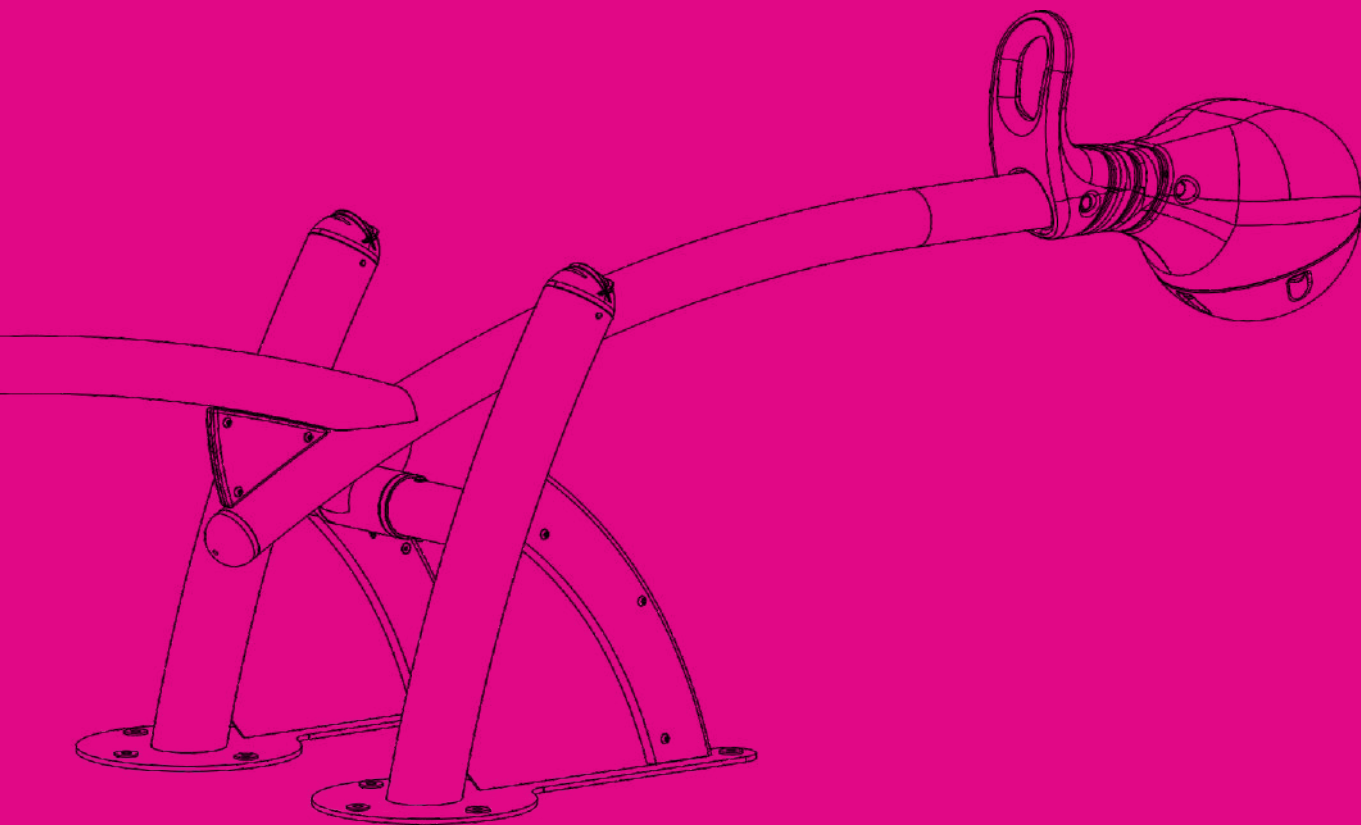

AKSESUAR ACCESSORIES

CA 122

Age / Yaş: 3+
Capacity / Kapasite: 2
Fall height / Max. düşme yüksekliği: 1,25 m
Safety area / Güvenlik alanı: 33,9 m²



CA 114

Age / Yaş: 3+
Capacity / Kapasite: 2
Fall height / Max. düşme yüksekliği: 1,25 m
Safety area / Güvenlik alanı: 36,2 m²



CA 124

Age / Yaş: 3+
Capacity / Kapasite: 2
Fall height / Max. düşme yüksekliği: 1,25 m
Safety area / Güvenlik alanı: 36,2 m²



CA 125

NEW
PRODUCT

Age / Yaş: 3+
Capacity / Kapasite: 4
Fall height / Max. düşme yüksekliği: 1,3 m
Safety area / Güvenlik alanı: 36,3 m²



CA 128

Age / Yaş: 3+
Capacity / Kapasite: 2
Fall height / Max. düşme yüksekliği: 1,25 m
Safety area / Güvenlik alanı: 33,3 m²



CA 126

Age / Yaş: 3+
Capacity / Kapasite: 2
Fall height / Max. düşme yüksekliği: 1,5 m
Safety area / Güvenlik alanı: 43,1 m²



CA 131

Age / Yaş: 3+
Capacity / Kapasite: 2
Fall height / Max. düşme yüksekliği: 1,55 m
Safety area / Güvenlik alanı: 31,1 m²



Age / Yaş: 3+
 Capacity / Kapasite: 1
 Fall height / Max. düşme yüksekliği: 1,25 m
 Safety area / Güvenlik alanı: 27,8 m²

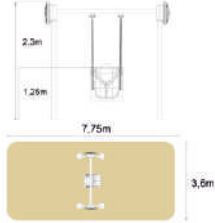

CA 132

Age / Yaş: 06-36 / 7+
 Capacity / Kapasite: 2
 Fall height / Max. düşme yüksekliği: 1,5 m
 Safety area / Güvenlik alanı: 25,6 m²

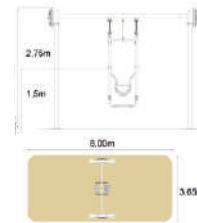

CA 133

**NEW
PRODUCT**

Age / Yaş: 06-36 / 7+
 Capacity / Kapasite: 4
 Fall height / Max. düşme yüksekliği: 1,75 m
 Safety area / Güvenlik alanı: 36,4 m²

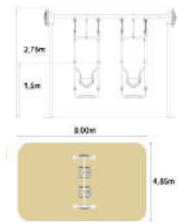

CA 134

**NEW
PRODUCT**

Age / Yaş: 06-36 / 7+
 Capacity / Kapasite: 2
 Fall height / Max. düşme yüksekliği: 1,3 m
 Safety area / Güvenlik alanı: 27,6 m²

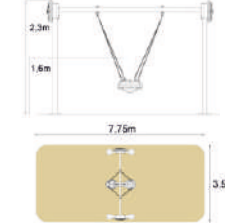

CA 135

**NEW
PRODUCT**

Age / Yaş: 06-36 / 7+
 Capacity / Kapasite: 4
 Fall height / Max. düşme yüksekliği: 1,6 m
 Safety area / Güvenlik alanı: 37 m²

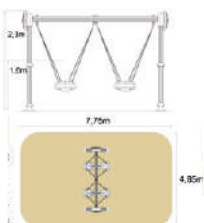

CA 136

**NEW
PRODUCT**

Age / Yaş: 06-36 / 7+
 Capacity / Kapasite: 4
 Fall height / Max. düşme yüksekliği: 1,3 m
 Safety area / Güvenlik alanı: 37 m²

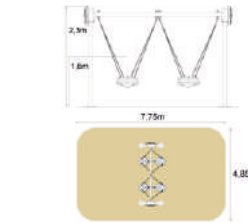

CA 137



Age / Yaş: 06-36
 Capacity / Kapasite: 4
 Fall height / Max. düşme yüksekliği: 1,1 m
 Safety area / Güvenlik alanı: 35,9 m²

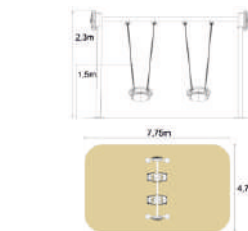

CA 138

**NEW
PRODUCT**

CA 202



Age / Yaş: 3+
 Capacity / Kapasite: 6
 Fall height / Max. düşme yüksekliği: 0,55 m
 Safety area / Güvenlik alanı: 24 m²

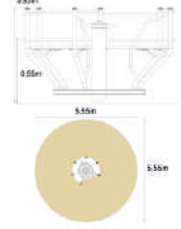

CA 203



Age / Yaş: 3+
 Capacity / Kapasite: 4
 Fall height / Max. düşme yüksekliği: 0,5 m
 Safety area / Güvenlik alanı: 29.2 m²

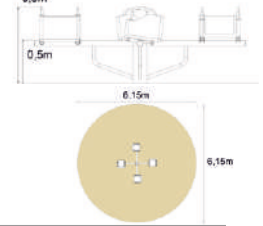

Age / Yaş: 5+
Capacity / Kapasite: 2
Fall height / Max. düşme yüksekliği: 1,25 m
Safety area / Güvenlik alanı: 15,5 m²

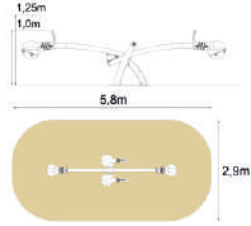

CA 311
**NEW
PRODUCT**



CA 402



Age / Yaş: 3+
Capacity / Kapasite: 1
Fall height / Max. düşme yüksekliği: 0,65 m
Safety area / Güvenlik alanı: 7 m²

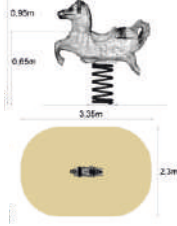

CA 403



Age / Yaş: 3+
Capacity / Kapasite: 1
Fall height / Max. düşme yüksekliği: 0,7 m
Safety area / Güvenlik alanı: 7,8 m²

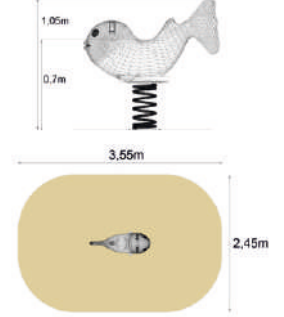

CA 404



Age / Yaş: 3+
Capacity / Kapasite: 1
Fall height / Max. düşme yüksekliği: 0,65 m
Safety area / Güvenlik alanı: 7,2 m²

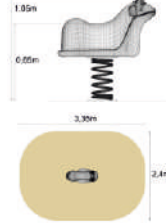

CA 405



Age / Yaş: 3+
Capacity / Kapasite: 1
Fall height / Max. düşme yüksekliği: 0,8 m
Safety area / Güvenlik alanı: 6,7 m²

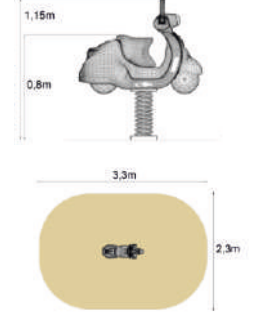

CA 406



Age / Yaş: 3+
Capacity / Kapasite: 1
Fall height / Max. düşme yüksekliği: 0,6 m
Safety area / Güvenlik alanı: 9 m²

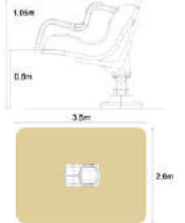

CA 408



Age / Yaş: 3+
Capacity / Kapasite: 1
Fall height / Max. düşme yüksekliği: 0,75 m
Safety area / Güvenlik alanı: 8,7 m²

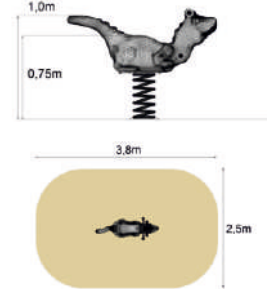

CA 409

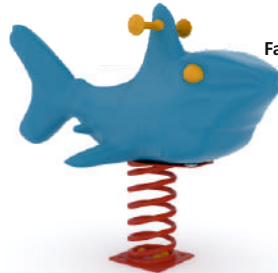

Age / Yaş: 3+
Capacity / Kapasite: 1
Fall height / Max. düşme yüksekliği: 0,7 m
Safety area / Güvenlik alanı: 11 m²

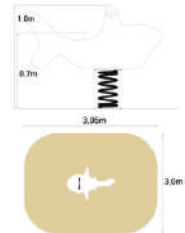

ROMANYA/ROMANIA

AKSESUAR/ ACCESSORIES

CA 552

NEW
PRODUCT



CA 553

NEW
PRODUCT

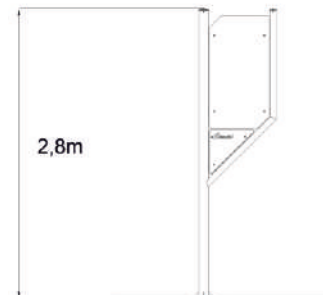

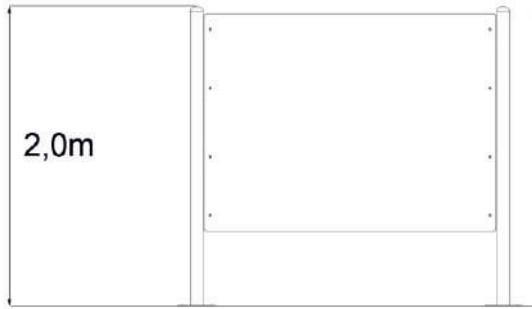
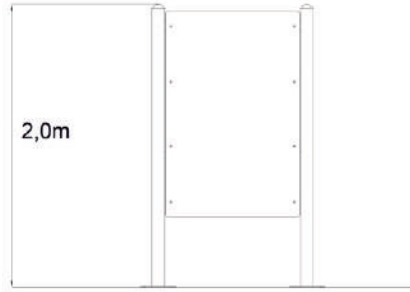



CA 650

Age / Yaş: 2+
Capacity / Kapasite: 2



CA 651

Age / Yaş: 2+
Capacity / Kapasite: 3



CA 653

Age / Yaş: 2+
Capacity / Kapasite: 8



CA 680

**NEW
PRODUCT**



Age / Yaş: 3+
Capacity / Kapasite: 3
Fall height / Max. düşme yüksekliği: 1,3 m
Safety area / Güvenlik alanı: 26,1 m²

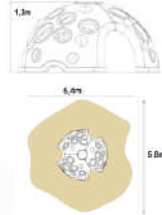

CA 690

NEW PRODUCT

Age / Yaş: 3+
Capacity / Kapasite: 2
Safety area / Güvenlik alanı: 21,8 m²

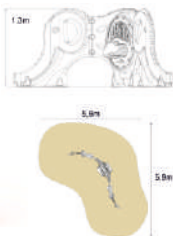

CA 691

Age / Yaş: 3+
Capacity / Kapasite: 4
Safety area / Güvenlik alanı: 27,2 m²

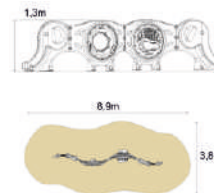

CA 692

NEW PRODUCT

Age / Yaş: 3+
Capacity / Kapasite: 8
Safety area / Güvenlik alanı: 37,4 m²

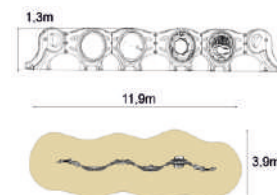

CA 693

NEW PRODUCT

Age / Yaş: 3+
Capacity / Kapasite: 4
Safety area / Güvenlik alanı: 25,7 m²

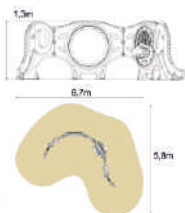

CA 694

NEW PRODUCT

Age / Yaş: 3+
Capacity / Kapasite: 8
Safety area / Güvenlik alanı: 34,6 m²

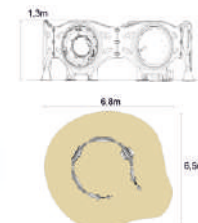

CA 695

NEW PRODUCT

Age / Yaş: 3+
Capacity / Kapasite: 12
Safety area / Güvenlik alanı: 46,9 m²

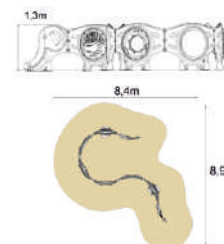

CA 696
**NEW
PRODUCT**

Age / Yaş: 3+
Capacity / Kapasite: 6
Safety area / Güvenlik alanı: 32,2 m²

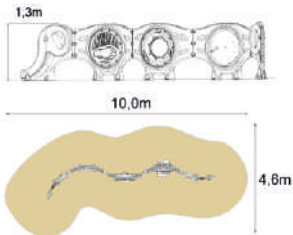

CA 697

**NEW
PRODUCT**

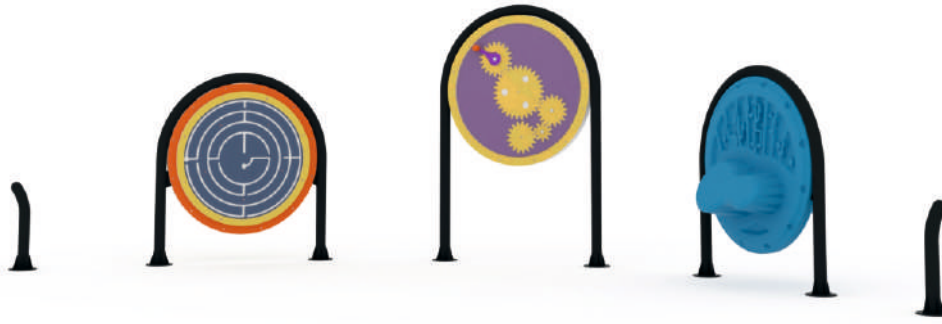

Age / Yaş: 3+
Capacity / Kapasite: 6
Safety area / Güvenlik alanı: 26 m²

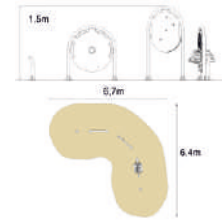

CA 698

**NEW
PRODUCT**

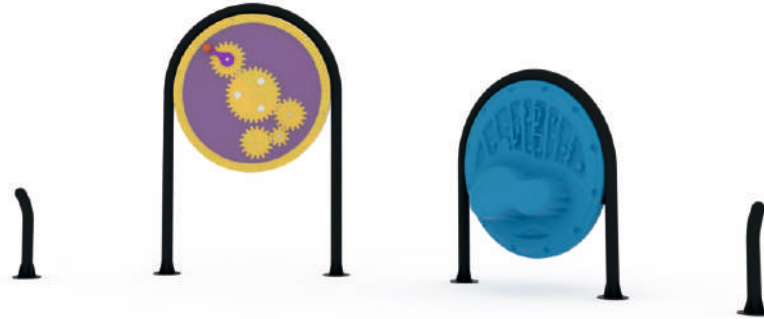

Age / Yaş: 3+
Capacity / Kapasite: 4
Safety area / Güvenlik alanı: 20,5 m²

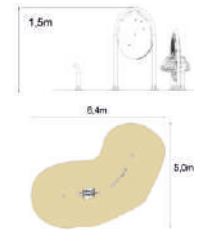

CA 699

**NEW
PRODUCT**



Age / Yaş: 3+
Capacity / Kapasite: 8
Safety area / Güvenlik alanı: 30,8 m²



Age / Yaş: 3+
Capacity / Kapasite: 3
Safety area / Güvenlik alanı: 14 m²

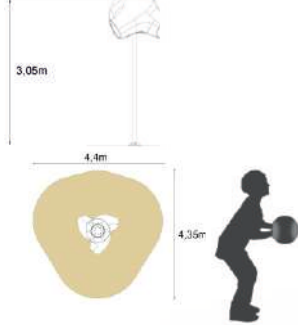

CA 701

CA 1300

Age / Yaş: 7+
Capacity / Kapasite: 1
Fall height / Max. düşme yüksekliği: 1,5 m
Safety area / Güvenlik alanı: 93,6 m²



Age / Yaş: 3+
Capacity / Kapasite: 3
Safety area / Güvenlik alanı: 21,6 m²

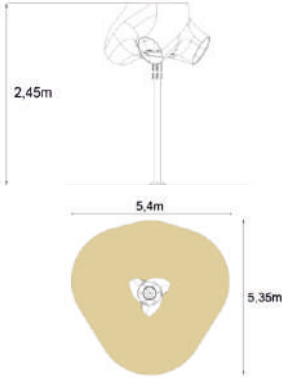

CA 702

CA 1302

Age / Yaş: 7+
Capacity / Kapasite: 1
Fall height / Max. düşme yüksekliği: 1,5 m
Safety area / Güvenlik alanı: 127,9 m²

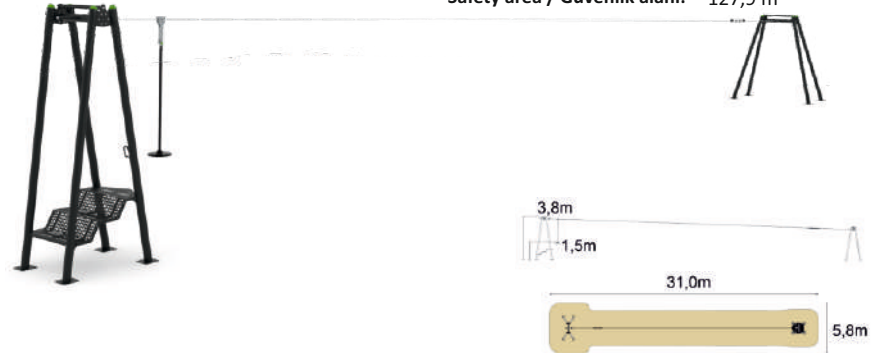

Age / Yaş: 3+
Capacity / Kapasite: 9
Safety area / Güvenlik alanı: 21,7 m²

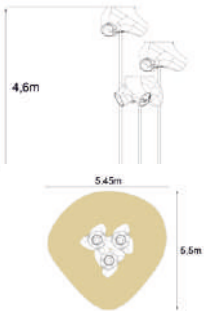

CA 703

CA 1303

Age / Yaş: 7+
Capacity / Kapasite: 1
Fall height / Max. düşme yüksekliği: 1,5 m
Safety area / Güvenlik alanı: 108,1 m²



CA 1401

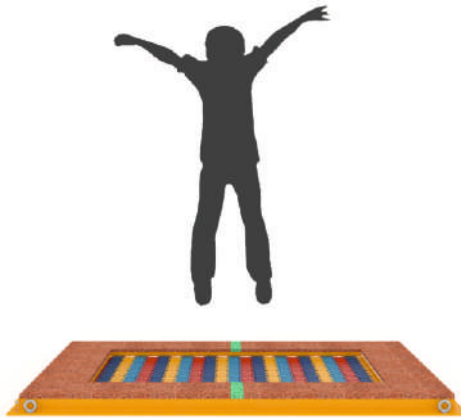

Age / Yaş: 3+
 Capacity / Kapasite: 3
 Fall height / Max. düşme yüksekliği: 1,0 m
 Safety area / Güvenlik alanı: 22,4 m²

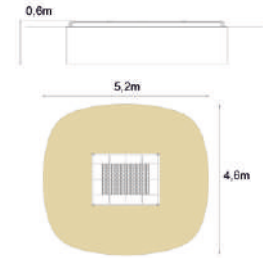

CA 1402



Age / Yaş: 3+
 Capacity / Kapasite: 2
 Fall height / Max. düşme yüksekliği: 1,0 m
 Safety area / Güvenlik alanı: 20 m²

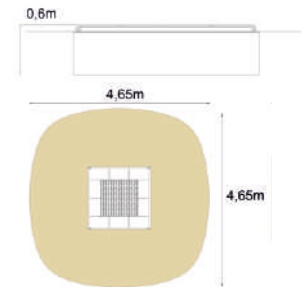

CA 1403

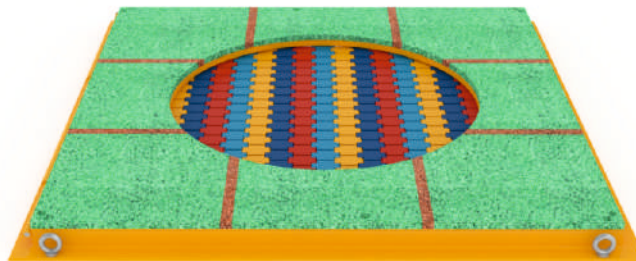

Age / Yaş: 3+
 Capacity / Kapasite: 2
 Fall height / Max. düşme yüksekliği: 1,0 m
 Safety area / Güvenlik alanı: 20 m²

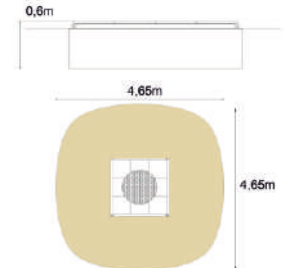

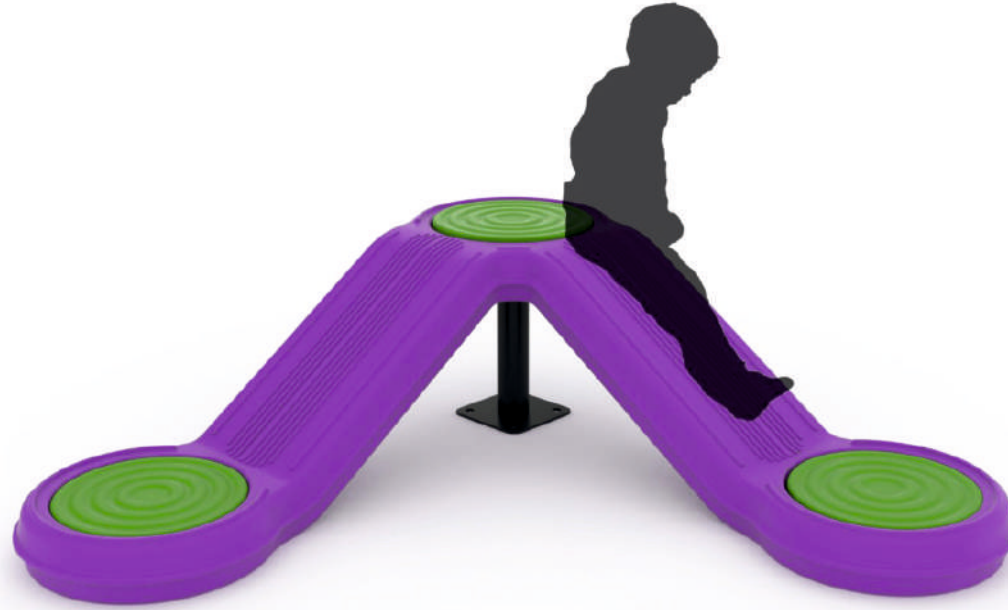

DGSS 29

**NEW
PRODUCT**

Age / Yaş: 3+
 Capacity / Kapasite: 2
 Fall height / Max. düşme yüksekliği: 0,6 m
 Safety area / Güvenlik alanı: 17,3 m²

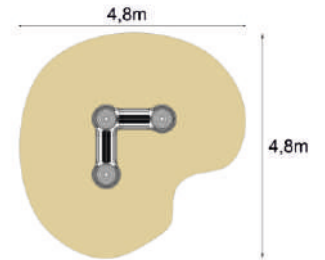

DGSS 30

**NEW
PRODUCT**

Age / Yaş: 3+
 Capacity / Kapasite: 2
 Fall height / Max. düşme yüksekliği: 0,65 m
 Safety area / Güvenlik alanı: 13,2 m²

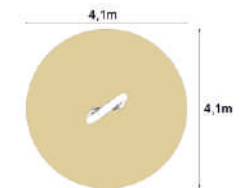
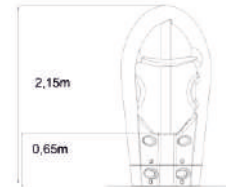





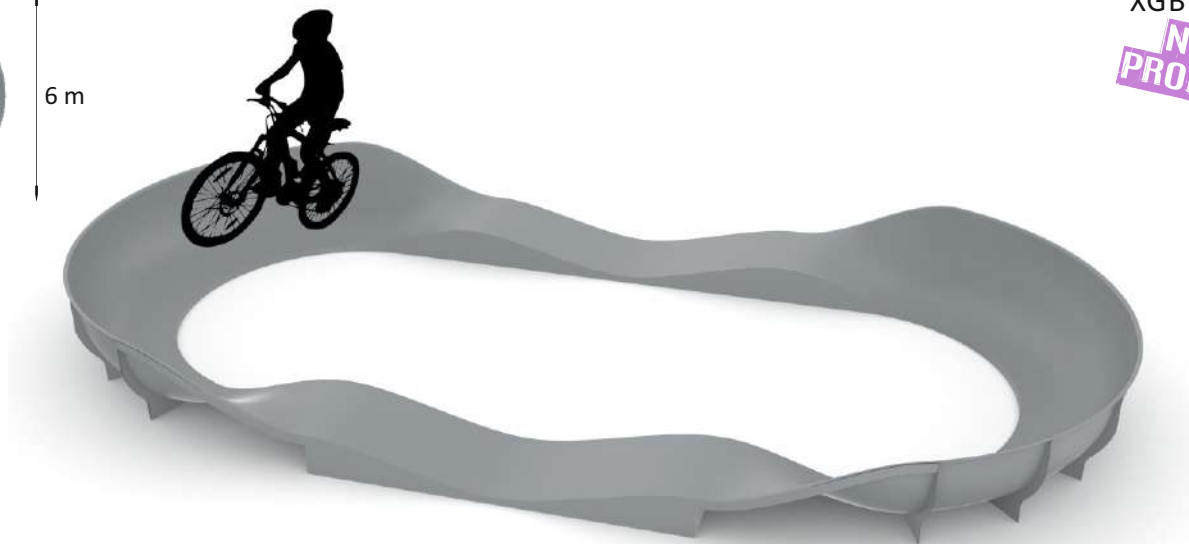
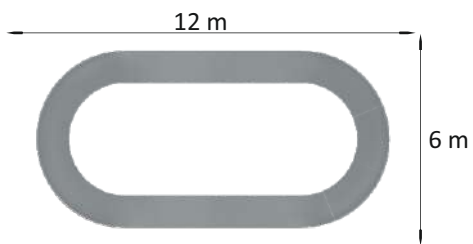

XGBT 101
**NEW
PRODUCT**

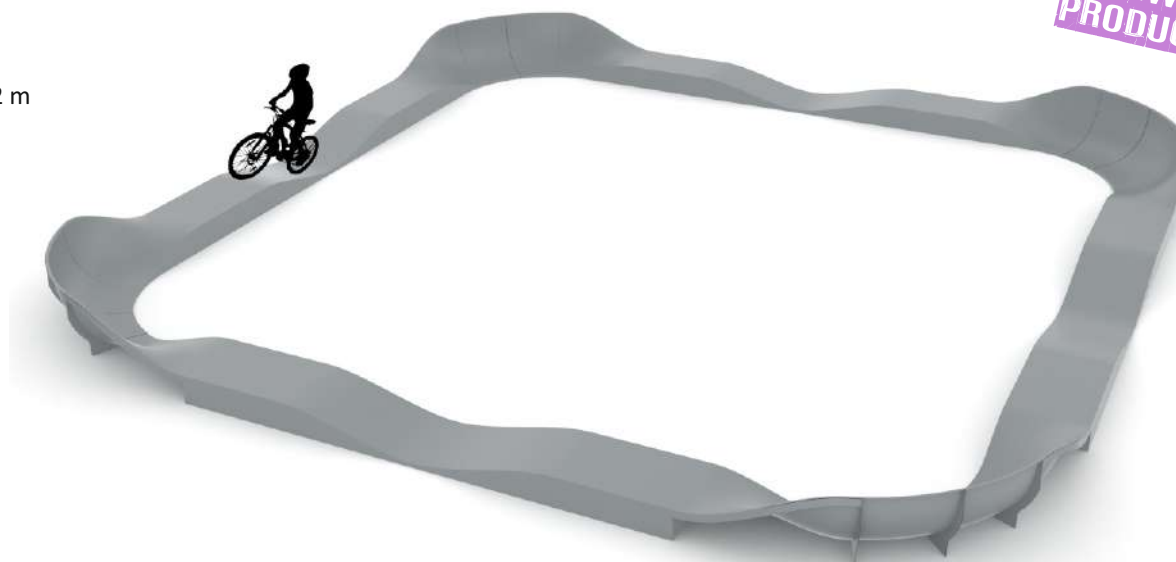
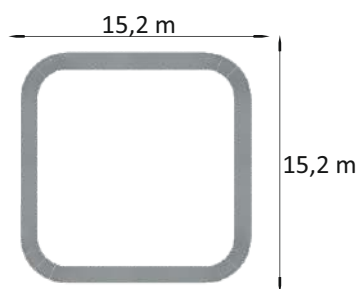

XGBT 102
**NEW
PRODUCT**

XGBT 103

**NEW
PRODUCT**

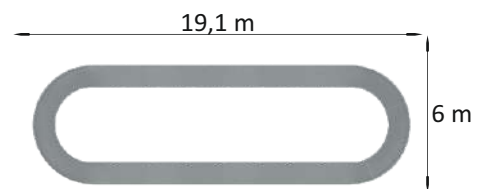
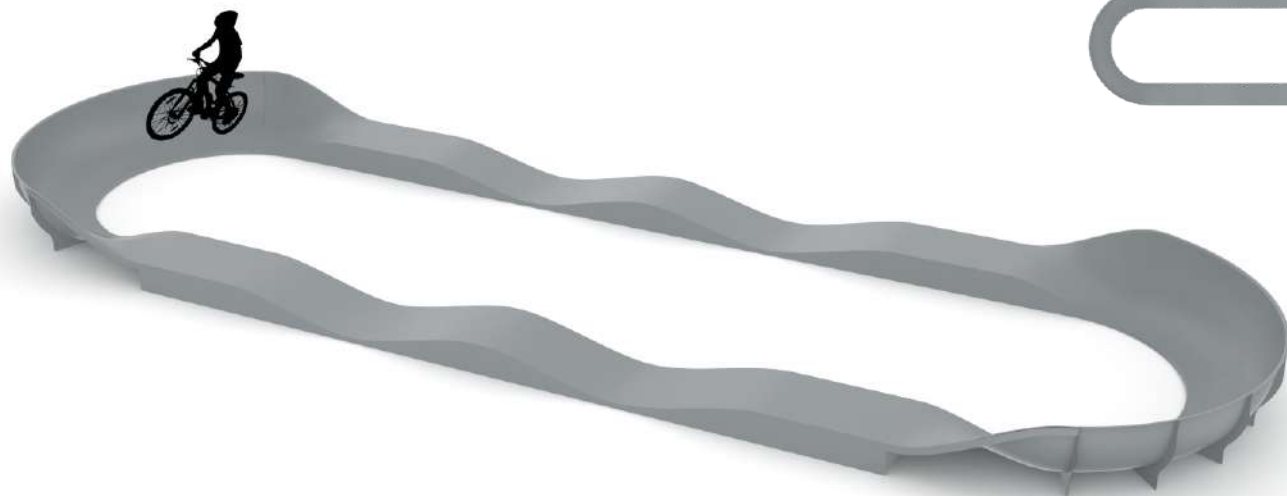

XGBT 104

**NEW
PRODUCT**

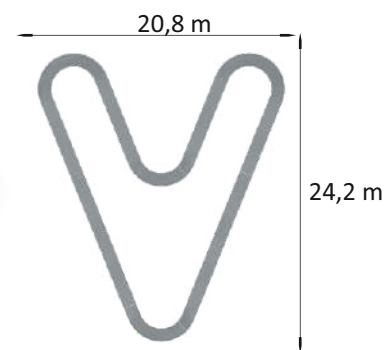

XGBT 105
**NEW
PRODUCT**

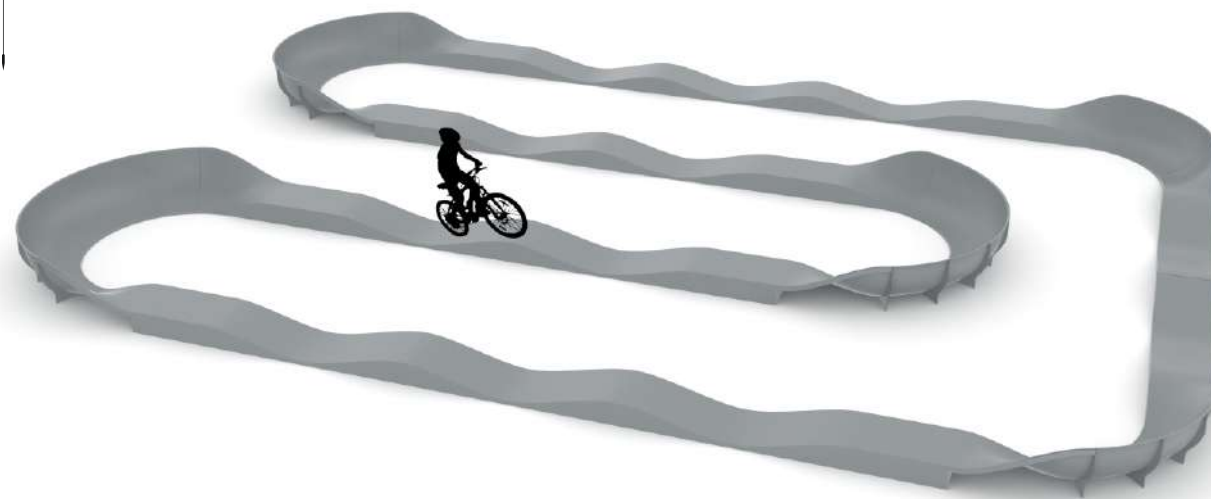
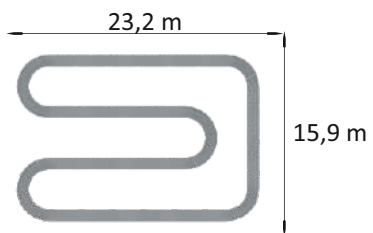

XGBT 106
**NEW
PRODUCT**

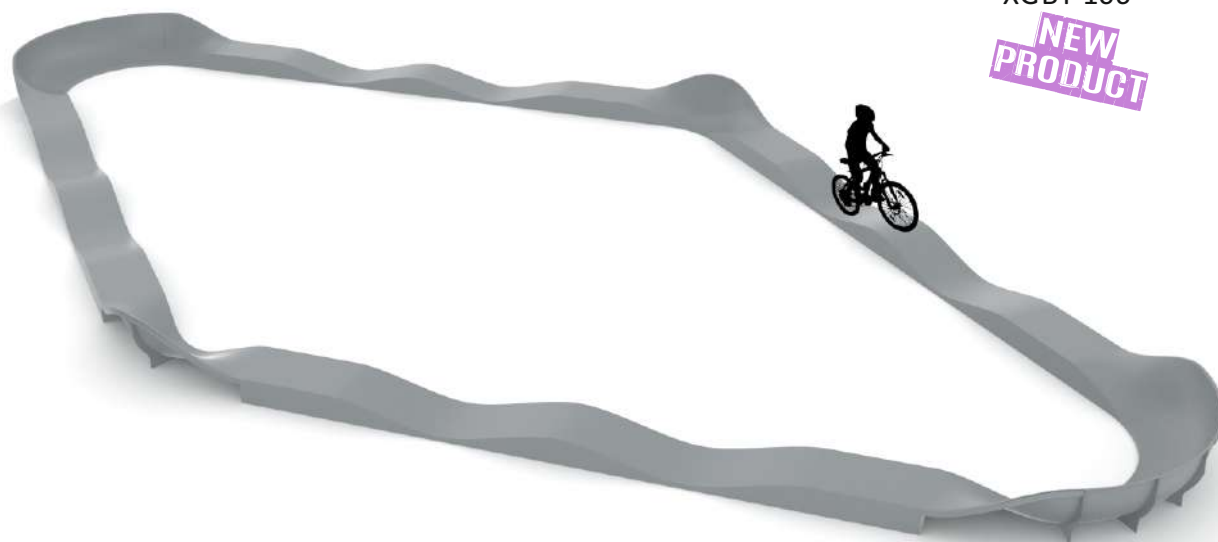
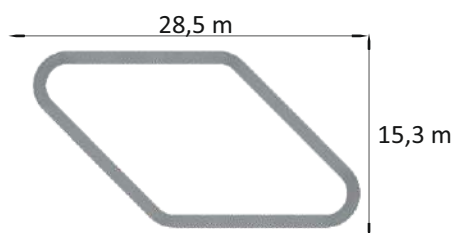

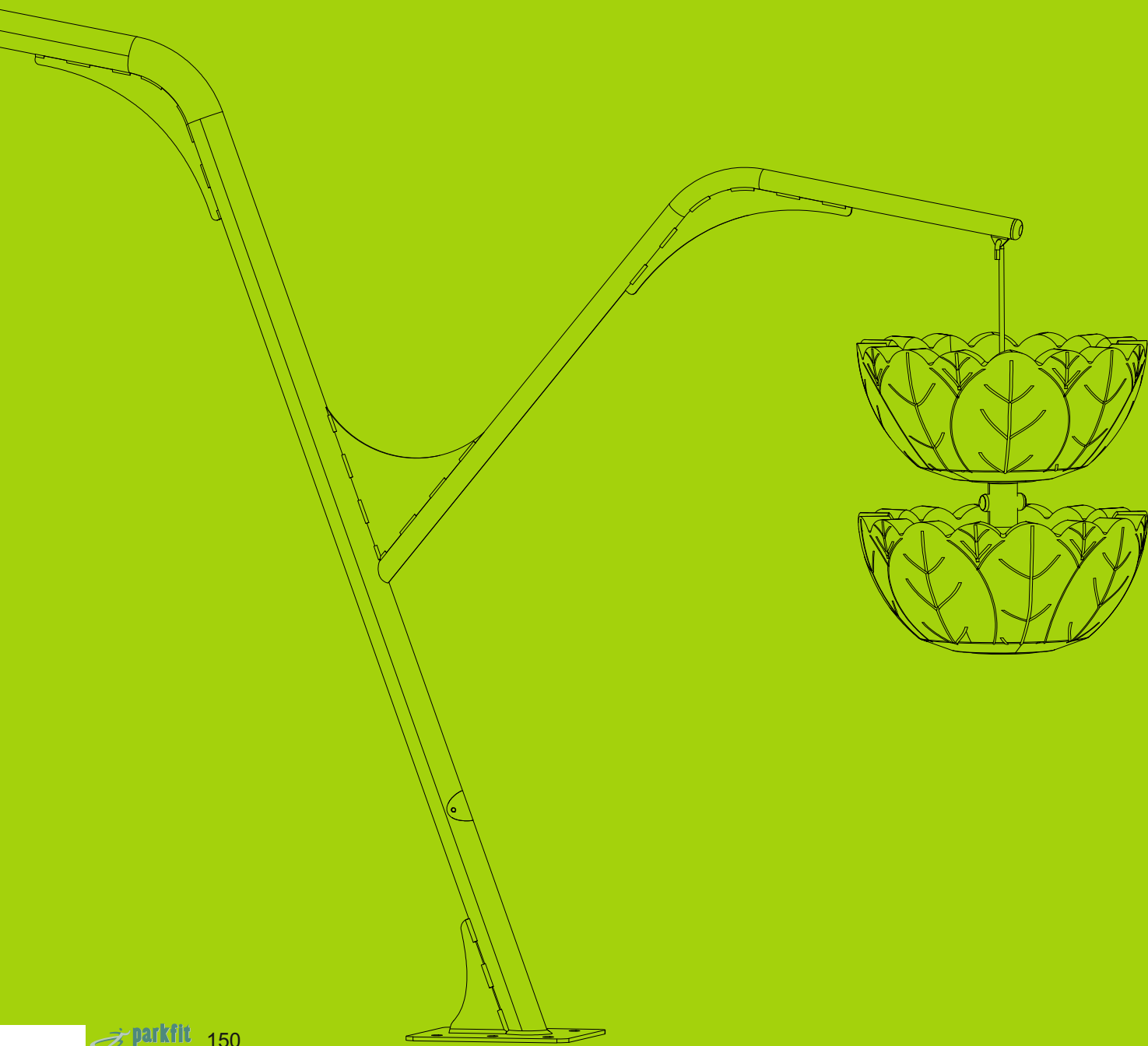

KENT EKİPMANLARI URBAN EQUIPMENT

152	CLASSICO KENT EKİPMANLARI	CLASSICO URBAN EQUIPMENT	152
156	3D EPDM KAUÇUK HAYVAN FİGÜRLERİ	3D EPDM RUBBER ANIMAL FIGURES	156
158	ZEMİN KAPLAMA	GROUND COATING	158

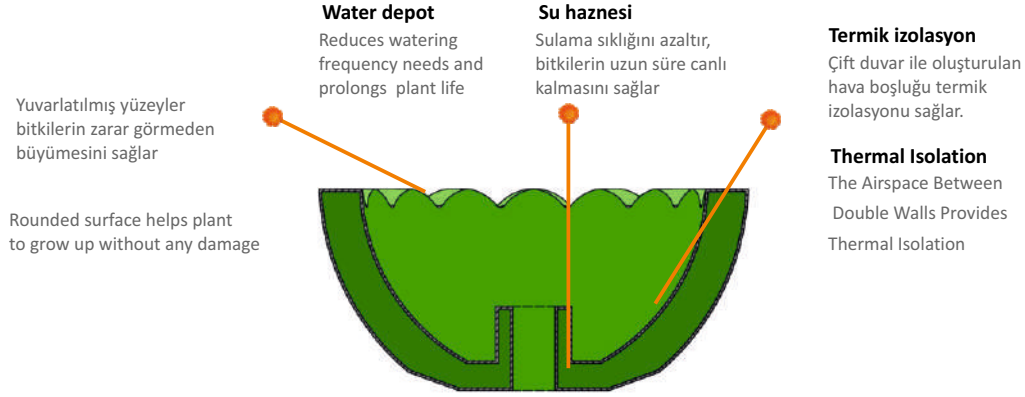

ÖZELLİKLERİ:

- Darbe ve ezilmelere karşı yüksek dayanım
- UV ışınlarına ve asit yağmuruna karşı yüksek dayanım
- Dört mevsim kullanılabilir
- Geri dönüşümlü malzeme
- Metal aksam; galvaniz kaplama ve elektrostatik boyalı
- İstenilen renk ve adette üretilir.

SPECIFICATIONS

- Rigid For Bumping And Crashing
- Uv Resistant
- Available For 4 Seasons
- Recyclable Material
- Metal parts galvanised coating and electrostatic painting
- Optional Colors

CSY 45 - 60 - 80



CSY 45
Çap /Dimension: 45 cm
Ağırlık / Weight: 2 kg
Toprak Hacmi / Soil Capacity: 14 lt.
Su Kapasitesi / Water Capacity: 2 lt.

CSY 60
Çap /Dimension: 60 cm
Ağırlık / Weight: 5 kg
Toprak Hacmi / Soil Capacity: 24 lt.
Su Kapasitesi / Water Capacity: 4,5 lt.

CSY 80
Çap /Dimension: 80 cm
Ağırlık / Weight: 6,5 kg
Toprak Hacmi / Soil Capacity: 75 lt.
Su Kapasitesi / Water Capacity: 6 lt.



CSD 100

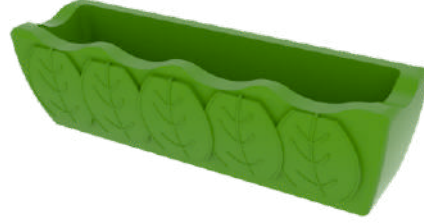

Ebat / Dimension: 100 x 27 x 29 cm
Ağırlık / Weight: 7 kg
Toprak Hacmi / Soil Capacity: 40 lt.
Su Kapasitesi / Water Capacity: 4 lt.

CSYY 65 - 85



Çap / Dimension: 65 cm
Ağırlık / Weight: 4,75 kg
Toprak Hacmi / Soil Capacity: 15 lt.
Su Kapasitesi / Water Capacity: 2,5 lt.

CSYY 85
Çap / Dimension: 85 cm
Ağırlık / Weight: 5,5 kg
Toprak Hacmi / Soil Capacity: 45 lt.
Su Kapasitesi / Water Capacity: 4,5 lt.

CES 04



Yükseklik/Height: 245 cm
Genişlik / Width: 75 cm
Taşıyıcı Boru / Pillar: 90 mm
Saksılar / Pot: 3 x CSYY 65,
1 x CSY 45,
1 x CSY 60,
1 x CSY 80

Yükseklik/Height: 96 cm
Genişlik / Width: 105 cm
Taşıyıcı Boru / Pillar: 60 mm
Saksılar/ Pot: 1 x CSD 100

CES 09



Yükseklik/Height: 245 cm
Genişlik / Width: 60 cm
Taşıyıcı Boru / Pillar: 90 mm
Saksılar/ Pot: 3 x CSY 60

CES 18



Yükseklik/Height: 370 cm
Genişlik / Width: 170 cm
Taşıyıcı Boru / Pillar: 140 mm
Saksılar/ Pot: 5 x CSY 45

CES 32



Yükseklik/Height: 280 cm
Genişlik / Width: 210 cm
Taşıyıcı Boru / Pillar: 90 mm
Kollar/ Arms: 42 mm
Saksılar/ Pot: 2 x CSY 60

CES 38

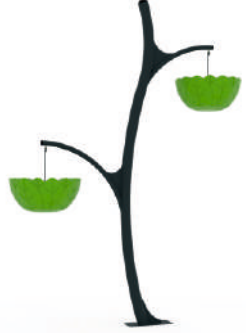

Yükseklik/Height: 240 cm
Genişlik / Width: 300 cm
Taşıyıcı Boru / Pillar: 90 mm
Kollar/ Arms: 42 mm
Saksılar/ Pot: 2 x CSY 45,
2 x CSY 60

CES 39



Yükseklik/Height: 160 cm
Genişlik / Width: 320 cm
Taşıyıcı Boru / Pillar: 90 mm
Saksılar/ Pot: 3 x CSY 60
2 x CSY 45

CES 40



Yükseklik/Height: 70 cm
Genişlik / Width: 180 cm
Taşıyıcı Boru / Pillar: 48 mm
Kollar/ Arms: 33 mm
Saksılar/ Pot: 2 x CSY 45

CES 42



Yükseklik/Height: 60 cm
Genişlik / Width: 60 cm
Taşıyıcı Boru / Pillar: 33 mm
Saksılar/ Pot: 1 x CSY 45

CES 43



CKS 101 DİNOZOR / DINOSAURS



Age / Yaş: 3+
Kapasite / Capacity: 3
Fall height / Max.
düşme yüksekliği: 1,6 m
Ebatlar / Dimensions: 1,45x 3,45 m
Ağırlık / Weight: 145 kg

CKS 102 İNEK / COW



Age / Yaş: 3+
Kapasite / Capacity: 3
Fall height / Max.
düşme yüksekliği: 0,8 m
Ebatlar / Dimensions: 1,7 x 3,2 m
Ağırlık / Weight: 135 kg



CKS 103 KAPLAN / TIGER



Age / Yaş: 3+
Kapasite / Capacity: 3
Fall height / Max.
düşme yüksekliği: 1,6 m
Ebatlar / Dimensions: 1,45x 3,45 m
Ağırlık / Weight: 145 kg

CKS 104 KABLUMBAĞA / TURTLE



Age / Yaş: 3+
Kapasite / Capacity: 3
Fall height / Max.
düşme yüksekliği: 1,6 m
Ebatlar / Dimensions: 1,45x 3,45 m
Ağırlık / Weight: 145 kg



Age / Yaş: 3+
Kapasite / Capacity: 3
Fall height / Max.
düşme yüksekliği: 0,8 m
Ebatlar / Dimensions: 1,7 x 3,2 m
Ağırlık / Weight: 130 kg



CKS 105
KURBAĞA / FROG

Age / Yaş: 3+
Kapasite / Capacity: 3
Fall height / Max.
düşme yüksekliği: 1,2 m
Ebatlar / Dimensions: 1,1 x 1,25 m
Ağırlık / Weight: 130 kg



CKS 106
MANTAR / MUSHROOM

Age / Yaş: 3+
Kapasite / Capacity: 3
Fall height / Max.
düşme yüksekliği: 0,8 m
Ebatlar / Dimensions: 1,7 x 3,2 m
Ağırlık / Weight: 130 kg



CKS 107
SİNCAP / SQUIRREL



Age / Yaş: 3+
Kapasite / Capacity: 3
Fall height / Max.
düşme yüksekliği: 0,8 m
Ebatlar / Dimensions: 2 x 3,6 m
Ağırlık / Weight: 130 kg



CKS 108
TİMSAH / ALLIGATOR

Age / Yaş: 3+
Kapasite / Capacity: 3
Fall height / Max.
düşme yüksekliği: 0,8 m
Ebatlar / Dimensions: 1,7 x 3,2 m
Ağırlık / Weight: 130 kg



CKS 109
TİRTİL /
CATERPILLAR

Age / Yaş: 3+
Kapasite / Capacity: 3
Fall height / Max.
düşme yüksekliği: 0,8 m
Ebatlar / Dimensions: 1,7 x 3,2 m
Ağırlık / Weight: 130 kg



CKS 110
YUNUS / DOLPHIN



SİLİNDİR TABANLI KAUÇUK/ CYLINDRICAL BOTTOM RUBBER TILES



Kauçuk zemin kaplama ile parklarda düşme yaralanmalarını azaltabilirsiniz.

You can reduce the number of injuries due to falling in parks, with our new rubber tiles.



ANA PARÇA
MAIN TILE



İÇBÜKEY KÖŞE
CONCAVE CORNER



KENAR RAMPASI
SIDE RAMP



DIŞBÜKEY KÖŞE
CONVEX CORNER

Kritik Düşme Yüksekliği Critical Fall Height	Gerekli Kauçuk Kalınlığı Required Rubber Thickness	Kauçuk Ebadı Rubber Tile Size
1,6 m	50 mm	500 x 500 mm
2,0 m	60 mm	500 x 500 mm
3,0 m	75 mm	500 x 500 mm
≥ 3 m	90 mm	500 x 500 mm

Kritik düşme yüksekliği test noktaları Critical Fall Height Test Points



* EN 1177 standardına uygundur.

*Tiles are in conformity with EN 1177 standards.

Yeni nesil ve interaktif oyun gruplarının, klasik oyun gruplarına göre düşme yükseklik riskleri fazladır. Dolayısı ile yeni nesil oyun gruplarındaki kritik düşme yüksekliğine uygun, standartların öngördüğü maximum darbe emici özelliğe sahip zemin kaplaması yapılmalıdır. Türkiye’de ilk ve tek üretilen bu kauçuk modeli ile 3 m ve üzeri kritik düşme yüksekliği karşılanabilmektedir.

New generation and interactive game groups have a higher risk of fall height than traditional game groups. Therefore, a floor cover which is appropriate for the critical fall height of new generation game groups and meets the maximum shock-absorbing criteria set forth by the standards, is essential. With this new rubber design, standards for 3 meters and higher fall height can be met.



ZEMİN KAPLAMA/ GROUND COATING



KARO KAUÇUK 50X50 RUBBER TILE 50X50



Kızıl ve yeşil renklerde
Kalınlıklar: 2,5 - 3 - 4 cm (*)
Dark red or green color
Thickness: 2.5 - 3 - 4cm (*)

KARO KAUÇUK 40X40 RUBBER TILE 40X40



Kızıl ve yeşil renklerde
Kalınlıklar: 2 -2,5 - 3 - 4 cm (*)
(*) % 1 ölçü toleransı vardır.
dark red or green color
Thickness: 2 - 2.5 - 3 - 4 cm (*)
(*) Size tolerance is 1%

KARO KAUÇUK 400X460 HEXAGONAL BLOCKS 400x460



Kızıl ve yeşil renklerde/400x460 mm
Kalınlıklar: 2 cm-2,5 cm-3 cm-4 cm
400x460mm/Dark red – Green color
Thickness:2cm - 2.5cm – 3cm – 4cm

DÖKME KAUÇUK / EPDM RUBBER

İstenilen kauçuk zemin kaplama malzemesi hem asfalt hem de beton zemin üzerine uygulanabilir. Su geçirimli, top ile oynanan bütün spor dalları ve yürüyüş yolları için uygun ve uzun ömürlü bir zemin kaplama malzemesidir.

Desired rubber floor covering material can be applied both on concrete and asphalt. It is a long-lasting floor covering material that is permeable to water, and suitable for running paths and all sports played with ball.



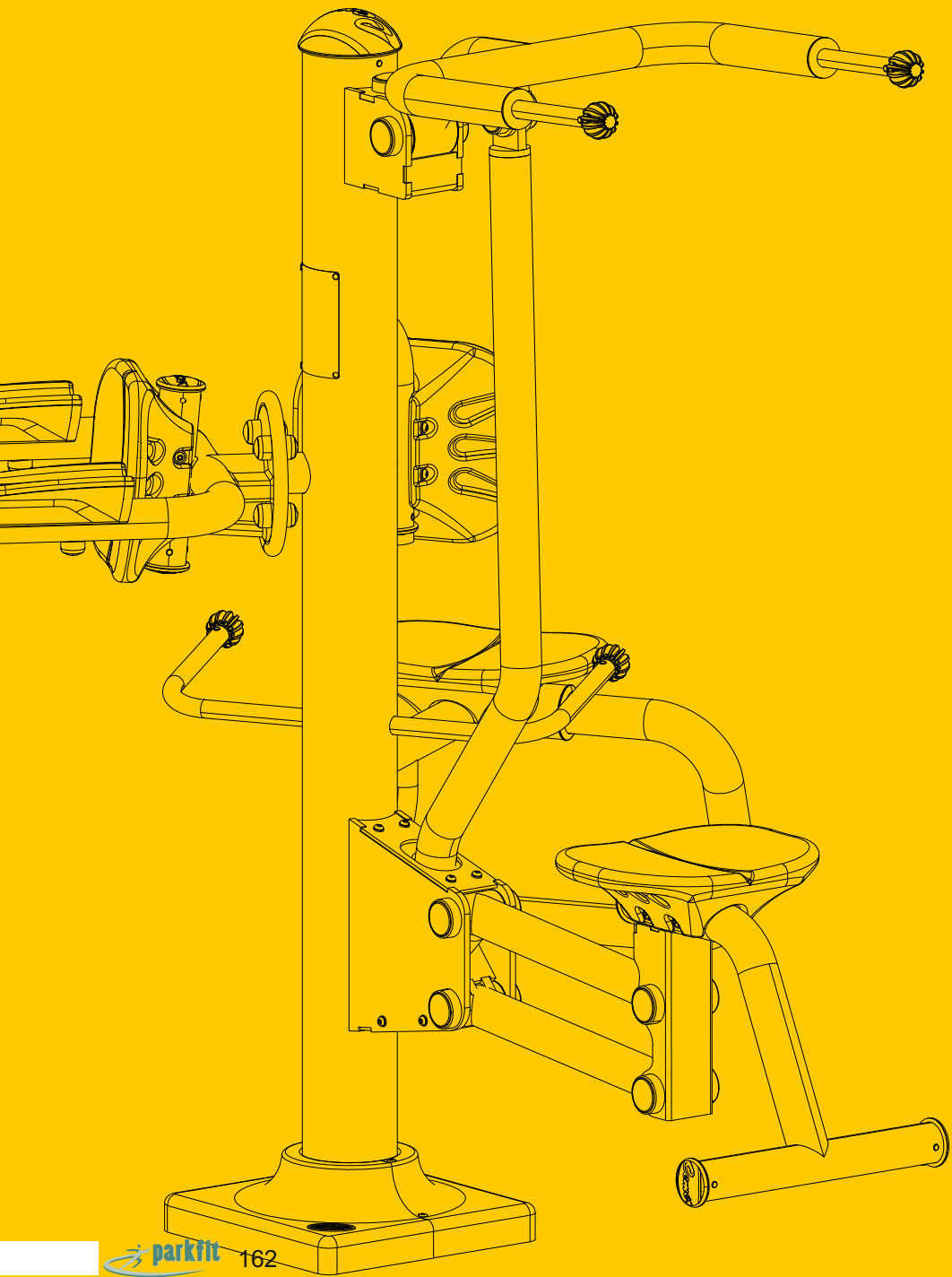

DIŐ MEKAN SPOR ALETLERİ OUTDOOR FITNESS EQUIPMENT

164	YETİŐKİNLER İÇİN FITNESS	ADULT FITNESS	164
180	REKLAM PANOLU FITNESS	BILBOARD FITNESS	180
183	FITNESS SETLERİ	FITNESS SETS	183
184	ENGELLİLER İÇİN FITNESS	HANDICAPPED FITNESS	184
186	ÇOCUKLAR İÇİN FITNESS	CHILDREN FITNESS	186

CF 01-1



Age / YaŐ: 18+
Capacity / Kapasite: 3
Safety area / Gvenlik alanı: 6,3 m²

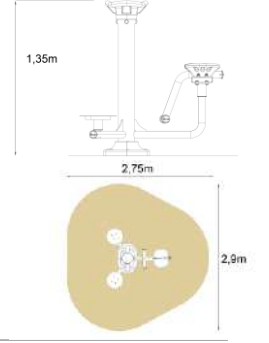

CF 02



Age / YaŐ: 18+
Capacity / Kapasite: 2
Safety area / Gvenlik alanı: 4,9 m²

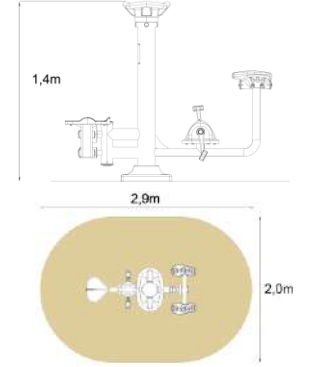

CF 03



Age / YaŐ: 18+
Capacity / Kapasite: 3
Safety area / Gvenlik alanı: 7 m²

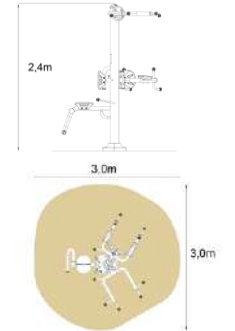

SLOVENYA/SLOVENIA



Yetiştirkinler için fitness/ adult fitness

DIŞ MEKAN SPOR ALETLERİ/
OUTDOOR FITNESS EQUIPMENT

MACARISTAN/HUNGARY



Age / Yaş: 18+
Capacity / Kapasite: 2
Safety area / Güvenlik alanı: 8,4 m²

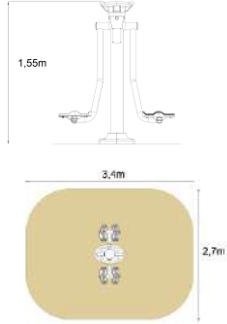

CF 04

Age / Yaş: 18+
Capacity / Kapasite: 2
Safety area / Güvenlik alanı: 3,3 m²

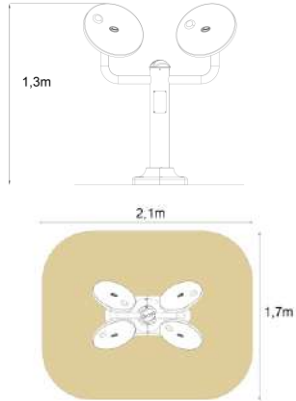

CF 05

Age / Yaş: 18+
Capacity / Kapasite: 2
Safety area / Güvenlik alanı: 9,2 m²

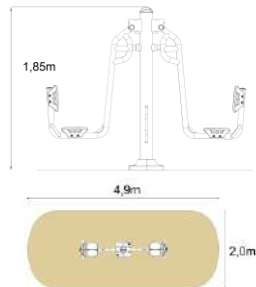

CF 06

CF 07



Age / YaŐ: 18+
Capacity / Kapasite: 2
Safety area / Gvenlik alanı: 9,1 m²

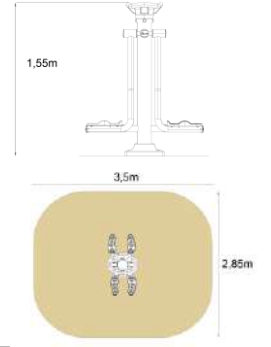

CF 09



Age / YaŐ: 18+
Capacity / Kapasite: 2
Safety area / Gvenlik alanı: 8,8 m²

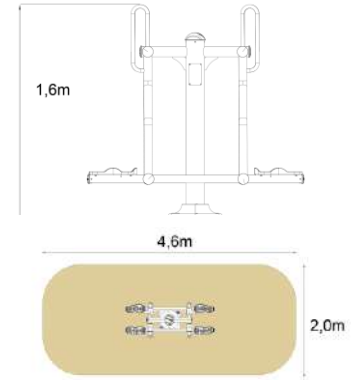

CF 10



Age / YaŐ: 18+
Capacity / Kapasite: 1
Safety area / Gvenlik alanı: 4,7 m²

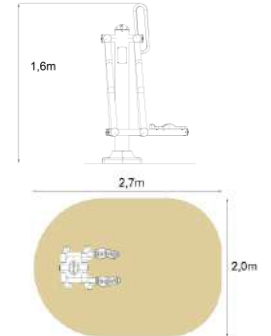

SLOVENYA/SLOVENIA



yeřiřkinler için fitness/ adult fitness

DIŐ MEKAN SPOR ALETLERİ/
OUTDOOR FITNESS EQUIPMENT

SLOVENYA/SLOVENIA



Age / Yaş: 18+
Capacity / Kapasite: 1
Safety area / Güvenlik alanı: 3,1 m²

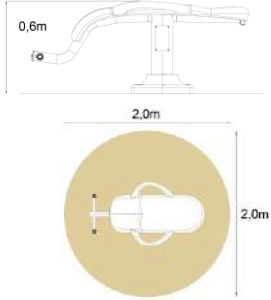

CF 11

Age / Yaş: 18+
Capacity / Kapasite: 2
Safety area / Güvenlik alanı: 9,5 m²

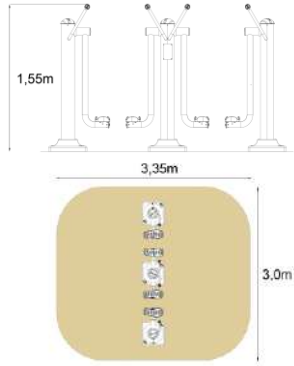

CF 13

Age / Yaş: 18+
Capacity / Kapasite: 2
Safety area / Güvenlik alanı: 4,7 m²

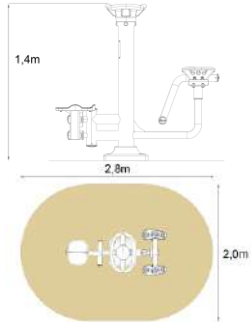

CF 16

CF 18-1



Age / YaŐ: 18+
Capacity / Kapasite: 3
Safety area / Gvenlik alanı: 7,4 m²

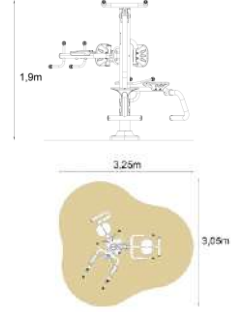

CF 18-2



Age / YaŐ: 18+
Capacity / Kapasite: 3
Safety area / Gvenlik alanı: 8,5 m²

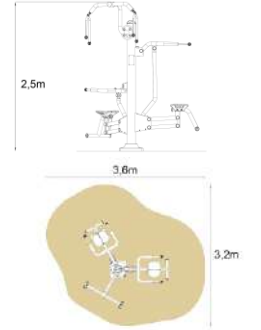

CF 19



Age / YaŐ: 18+
Capacity / Kapasite: 1
Safety area / Gvenlik alanı: 6,1 m²

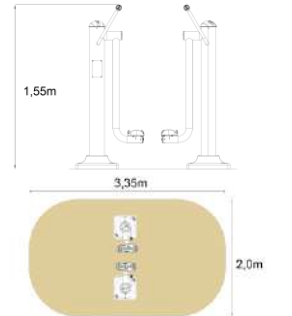

ALMANYA/GERMANY



çocuklar için fitness / adult fitness
DIŐ MEKAN SPOR ALETLERİ/
OUTDOOR FITNESS EQUIPMENT

LİTVANYA/LITHUANIA



Age / Yaş: 18+
Capacity / Kapasite: 2
Safety area / Güvenlik alanı: 5 m²

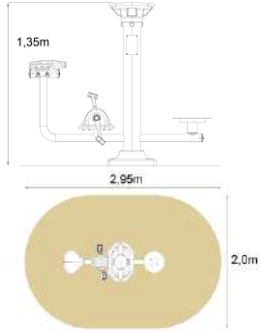

CF 20

Age / Yaş: 18+
Capacity / Kapasite: 1
Safety area / Güvenlik alanı: 3,1 m²

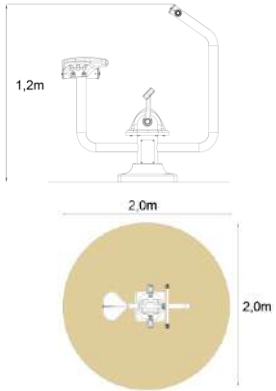

CF 22

Age / Yaş: 18+
Capacity / Kapasite: 2
Safety area / Güvenlik alanı: 9,6 m²

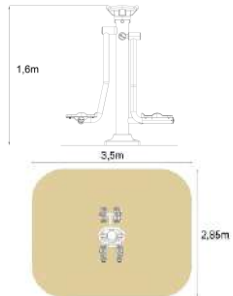

CF 27

CF 28



Age / YaŐ: 18+
Capacity / Kapasite: 1
Safety area / Gvenlik alanı: 6,2 m²

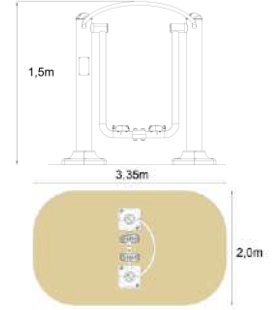

CF 29



Age / YaŐ: 18+
Capacity / Kapasite: 2
Safety area / Gvenlik alanı: 9,2 m²

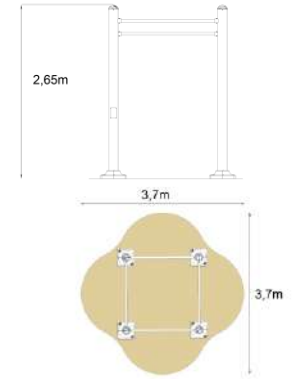

CF 30



Age / YaŐ: 18+
Capacity / Kapasite: 1
Safety area / Gvenlik alanı: 8,5 m²

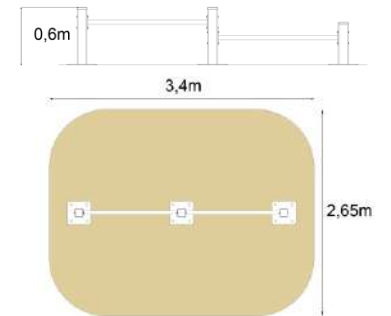

ALMANYA/GERMANY



yetişkinler için fitness/ adult fitness

DIŞ MEKAN SPOR ALETLERİ/
OUTDOOR FITNESS EQUIPMENT

CF 31



Age / YaŐ: 18+
Capacity / Kapasite: 1
Safety area / Gvenlik alanı: 5,9 m²

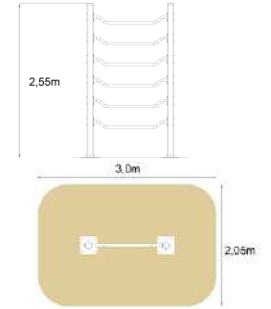

CF 32



Age / YaŐ: 18+
Capacity / Kapasite: 1
Safety area / Gvenlik alanı: 8,5 m²

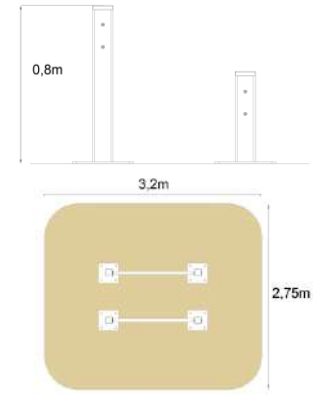

CF 33



Age / YaŐ: 18+
Capacity / Kapasite: 1
Safety area / Gvenlik alanı: 7,2 m²

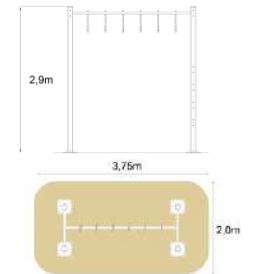

Age / Yaş: 18+
Capacity / Kapasite: 1
Safety area / Güvenlik alanı: 9 m²

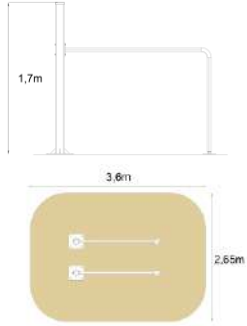

CF 34

Age / Yaş: 18+
Capacity / Kapasite: 1
Safety area / Güvenlik alanı: 10,3 m²

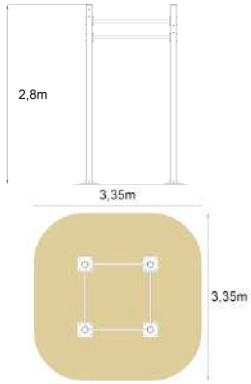

CF 35

Age / Yaş: 18+
Capacity / Kapasite: 1
Safety area / Güvenlik alanı: 8,5 m²

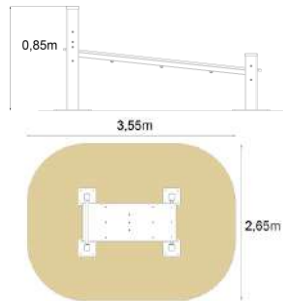

CF 36

CFR 01



Age / Yaő: 18+
Capacity / Kapasite: 2
Safety area / Gvenlik alanı: 4,3 m²

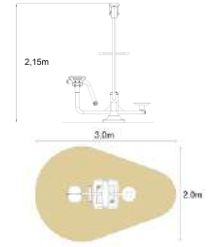

CFR 02



Age / Yaő: 18+
Capacity / Kapasite: 2
Safety area / Gvenlik alanı: 5,2 m²

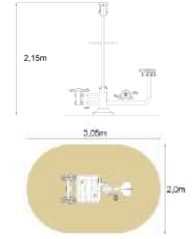

CFR 04



Age / Yaő: 18+
Capacity / Kapasite: 2
Safety area / Gvenlik alanı: 7,2 m²

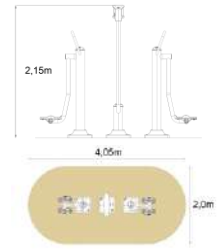

CFR 05



Age / Yaő: 18+
Capacity / Kapasite: 2
Safety area / Gvenlik alanı: 9,1 m²

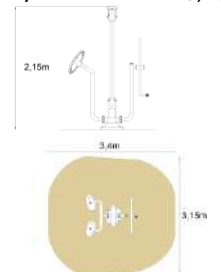

Age / Yaş: 18+
Capacity / Kapasite: 2
Safety area / Güvenlik alanı: 5,7 m²

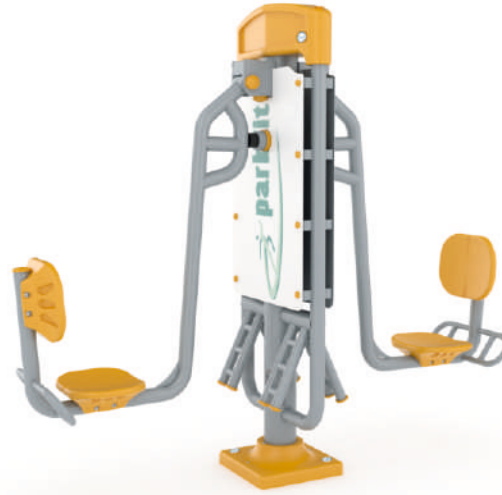
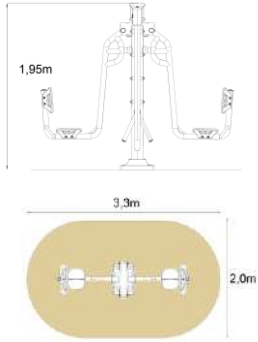

CFR 06

Age / Yaş: 18+
Capacity / Kapasite: 2
Safety area / Güvenlik alanı: 9,8 m²

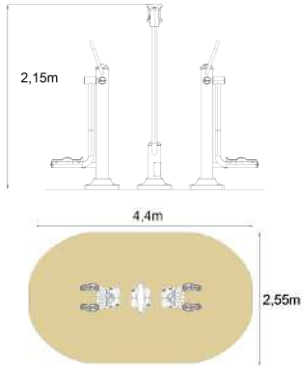

CFR 07

Age / Yaş: 18+
Capacity / Kapasite: 2
Safety area / Güvenlik alanı: 6,9 m²

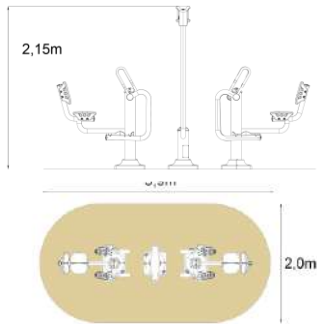

CFR 12

CFR 13



Age / Yaő: 18+
Capacity / Kapasite: 2
Safety area / Gvenlik alanı: 9,1 m²

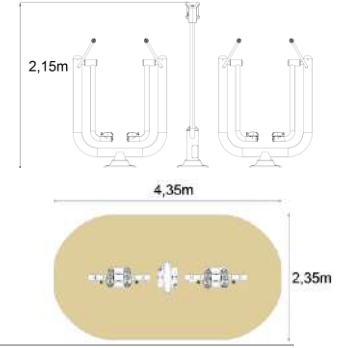

CFR 18



Age / Yaő: 18+
Capacity / Kapasite: 2
Safety area / Gvenlik alanı: 6 m²

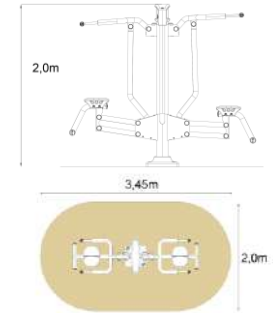

CFR 19



Age / Yaő: 18+
Capacity / Kapasite: 2
Safety area / Gvenlik alanı: 10,3 m²

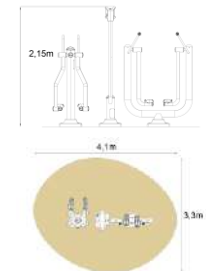

Age / Yaş: 18+
Capacity / Kapasite: 6
Safety area / Güvenlik alanı: 18,2 m²

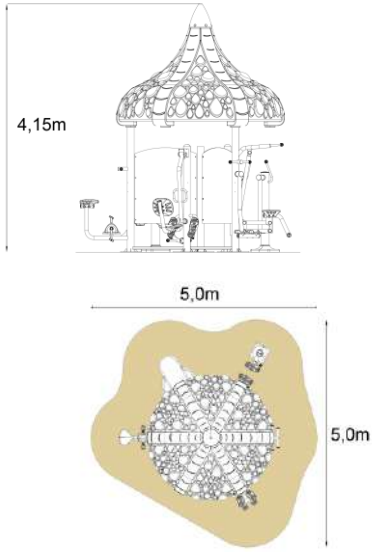

CFG 02

Age / Yaş: 18+
Capacity / Kapasite: 6
Safety area / Güvenlik alanı: 18,6 m²

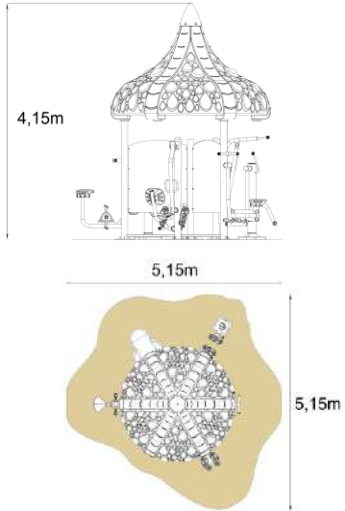

CFG 03

CFE 02



Age / Yaő: 18+
Capacity / Kapasite: 1
Safety area / Gvenlik alanı: 3,5 m²

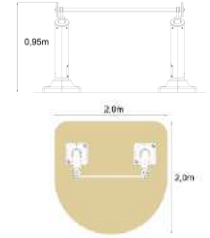

CFE 04



Age / Yaő: 18+
Capacity / Kapasite: 1
Safety area / Gvenlik alanı: 4,1 m²

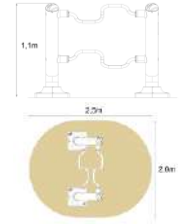

CFE 05



Age / Yaő: 18+
Capacity / Kapasite: 2
Safety area / Gvenlik alanı: 4,1 m²

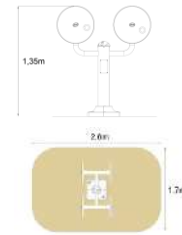

CFE 06



Age / Yaő: 18+
Capacity / Kapasite: 1
Safety area / Gvenlik alanı: 5,7 m²

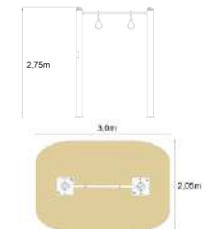

Age / Yaş: 18+
Capacity / Kapasite: 2
Safety area / Güvenlik alanı: 6,6 m²

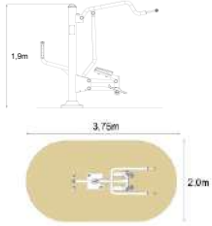

CFE 08

Age / Yaş: 18+
Capacity / Kapasite: 1
Safety area / Güvenlik alanı: 3,1 m²

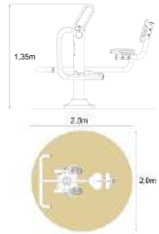

CFE 10

Age / Yaş: 18+
Capacity / Kapasite: 1
Safety area / Güvenlik alanı: 4 m²

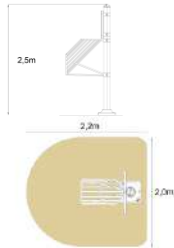

CFE 11

Age / Yaş: 18+
Capacity / Kapasite: 3
Safety area / Güvenlik alanı: 10,5 m²

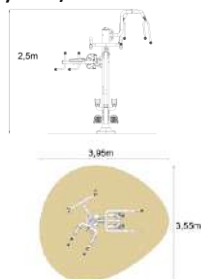

CFE 12

İNGİLTERE/ENGLAND



CFM 02

Age / Yaş: 12+
Capacity / Kapasite: 4
Safety area / Güvenlik alanı: 13,4 m²

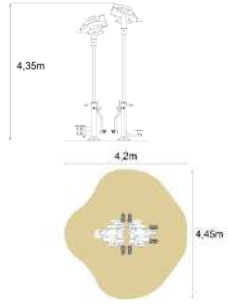

CFM 04

Age / Yaş: 12+
Capacity / Kapasite: 4
Safety area / Güvenlik alanı: 12,9 m²

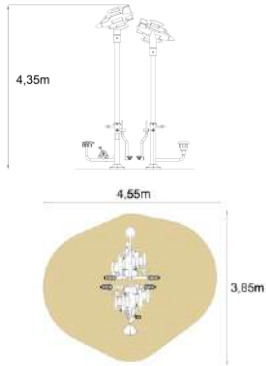

CFM 05

Age / Yaş: 12+
Capacity / Kapasite: 4
Safety area / Güvenlik alanı: 14,3 m²

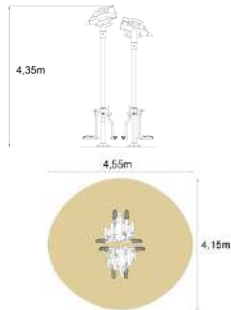

CFM 08



Age / Yaő: 12+
Capacity / Kapasite: 1
Safety area / Güvenlik alanı: 3,1 m²

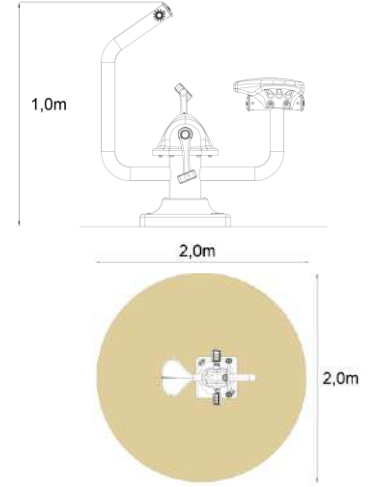

CFM 09



Age / Yaő: 12+
Capacity / Kapasite: 8
Safety area / Güvenlik alanı: 22 m²

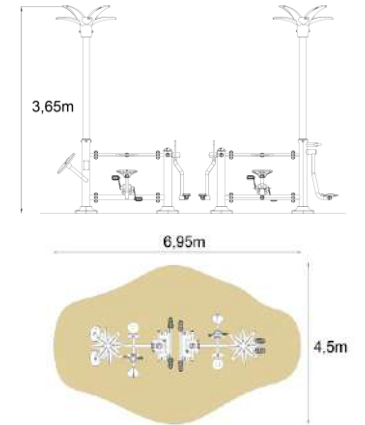

İNGİLTERE/ENGLAND

Çocuklar için fitness ve çocuklar için fitness
DIŞ MEKAN SPOR ALETLERİ/
OUTDOOR FITNESS EQUIPMENT



DIŐ MEKAN SPOR ALETLERİ/
OUTDOOR FITNESS EQUIPMENT

çocuklar için fitness/ children fitness

İNGİLTERE/ENGLAND



SİNGAPUR/SINGAPORE



İNGİLTERE/ENGLAND



LİTVANYA/LITHUANIA



İNGİLTERE/ENGLAND



CFM 10

Age / Yaş: 12+
Capacity / Kapasite: 4
Safety area / Güvenlik alanı: 10,9 m²

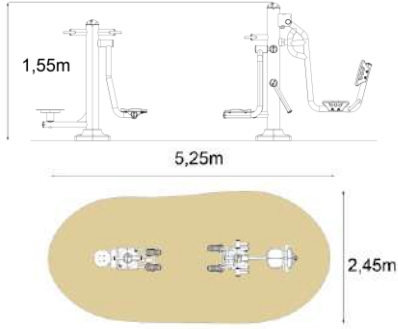

CFM 11

Age / Yaş: 12+
Capacity / Kapasite: 3
Safety area / Güvenlik alanı: 7,8 m²

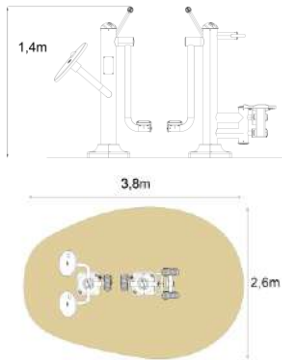

CFM 12

Age / Yaş: 12+
Capacity / Kapasite: 2
Safety area / Güvenlik alanı: 8,3 m²

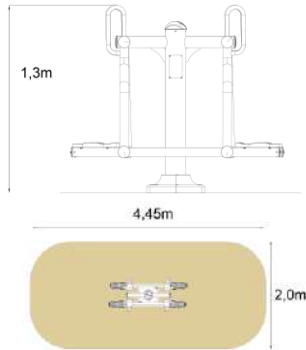





PARKFİT KENT EKİPMANLARI SAN. ve TİC. LTD. ŞTİ.

434 Sokak No:5 İç Kapı: 1- 2 Torbalı- İzmir / TÜRKİYE

Tel: +90 232 853 87 04- Fax: +90 232 853 97 58

www.parkfit.com.tr